

SUITABLE FOR GLOBAL FAMOUS BRAND



YEM engine parts



Scan QR code to follow account



YEM[®]

Your Engine Master

YEM[®]

What can we offer?

More than engine spare parts!



C 公司简介

COMPANY PROFILE

广州复格工程机配件有限公司位于中国广东省广州市，是一家集生产、销售为一体的工程机械配件公司。自2001年成立以来一直从事工程机械发动机配件，经过多年的努力。在同行领域颇有影响，深受客户好评。

本公司专业批发久保田，洋马、康明斯、五十铃、小松、卡特、大宇、日立、神钢、三菱、日野、沃尔沃、尼桑、利勃海尔等挖掘机替代配件。

各机型正副厂发动机件:活塞环，缸套，活塞，活塞销，大修包，汽缸床，进排气门，导管，座圈，大小瓦，止推片，连杆，曲轴，凸轮轴，水泵，机油泵，油嘴，柱塞，出油阀，机油散热器边盖，机芯，增压器经销电器件，四轮一带底盘件(包括支重轮，托轮，引导轮，驱动齿，链轨总成)

公司一贯秉承着“诚信为本，服务至上，优质取胜”的理念，诚挚地欢迎国内外的新老客户前来洽谈咨询!期待与您有愉快的合作，实现双赢!

Guangzhou Fuge Construction Machinery Parts Co., Ltd. is located in Guangzhou City, Guangdong, Province, China. It is a construction machinery parts and accessories company integrating production and sales. Since its establishment in 2001, it has been engaged in engineering machinery engine parts. After years of hard work, it has a considerable influence in the field of peers and is well received by customers.

We have about 1,000,000 engine parts. We are specialized in different brands of diesel engine parts like Kubota, Yanmar, Liebherr, Isuzu, Mitsubishi, Komatsu, Perkins, Doosan, Cummins, Caterpillar, Volvo, Hino, Nissan, etc.

Engine parts of each model and auxiliary factory: piston ring, oil cylinder, piston, piston pin, large repair kit, cylinder bed, exhaust valve, guide tube, seat, size tile, thrust axle, crank column, axle pin oil fork, oil pump, oil pump, hub, cover, movement, tanker, warp beam, four pieces of equipment. Wheel-rail target guidance (including rollers, drive teeth, total)

“Honesty-oriented, service first, quality win” is our principle. We sincerely welcome the new and old customers from home and abroad to negotiate and consult business. Looking forward to having pleasant cooperation with you and realizing win-win!

YEM has full private label packaging capabilities to meet all customers' need.

YEM decides to establish the international multi-languages sales teams and recruit brand agents with sincerity, the languages including:

- English
- Spanish
- Portuguese
- Arabic
- Russian
- Mongolian

YEM products are tested to OEM specifications.

YEM products are engineered and developed based on OEM samples.

YEM offer 6 months products quality warranty.



We supply professional comprehensive construction machinery. Such as excavator, bulldozer, loader, carrier, etc. We also provides mining, coal, port, oil field overhaul and other services.



Please feel free to contact us if you need more information. Hope we can have good cooperation and become friends.

SUITABLE FOR GLOBAL FAMOUS BRAND



“ We manage and innovate consistently, which is appreciated by our users. It is our responsibility to meet the needs of our customers and manufacture excellent quality products. ”

YEM

For Excavator, Loader, Refrigerator, Generator

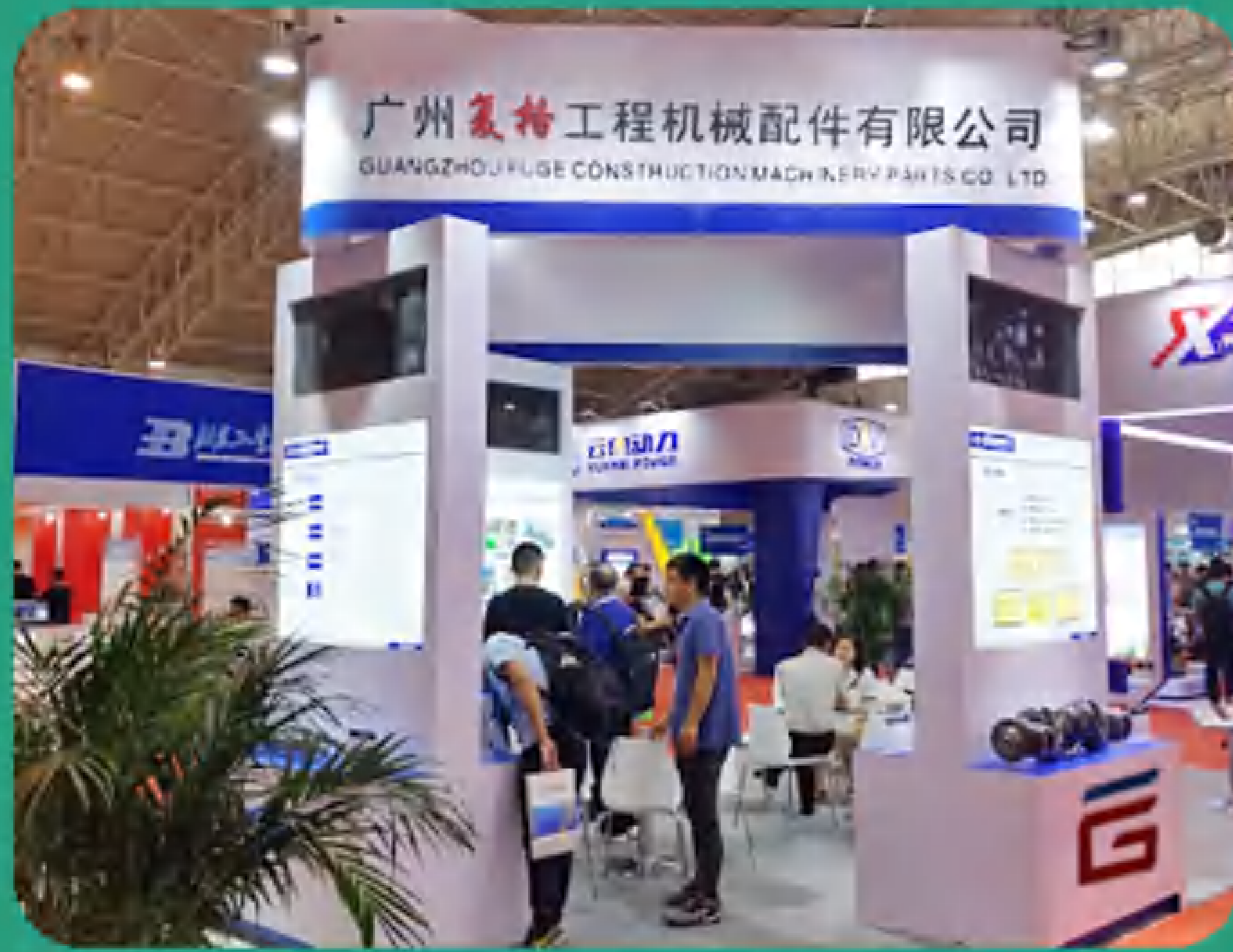

2006 - In Shanghai



2012 - In Germany



2018



2019

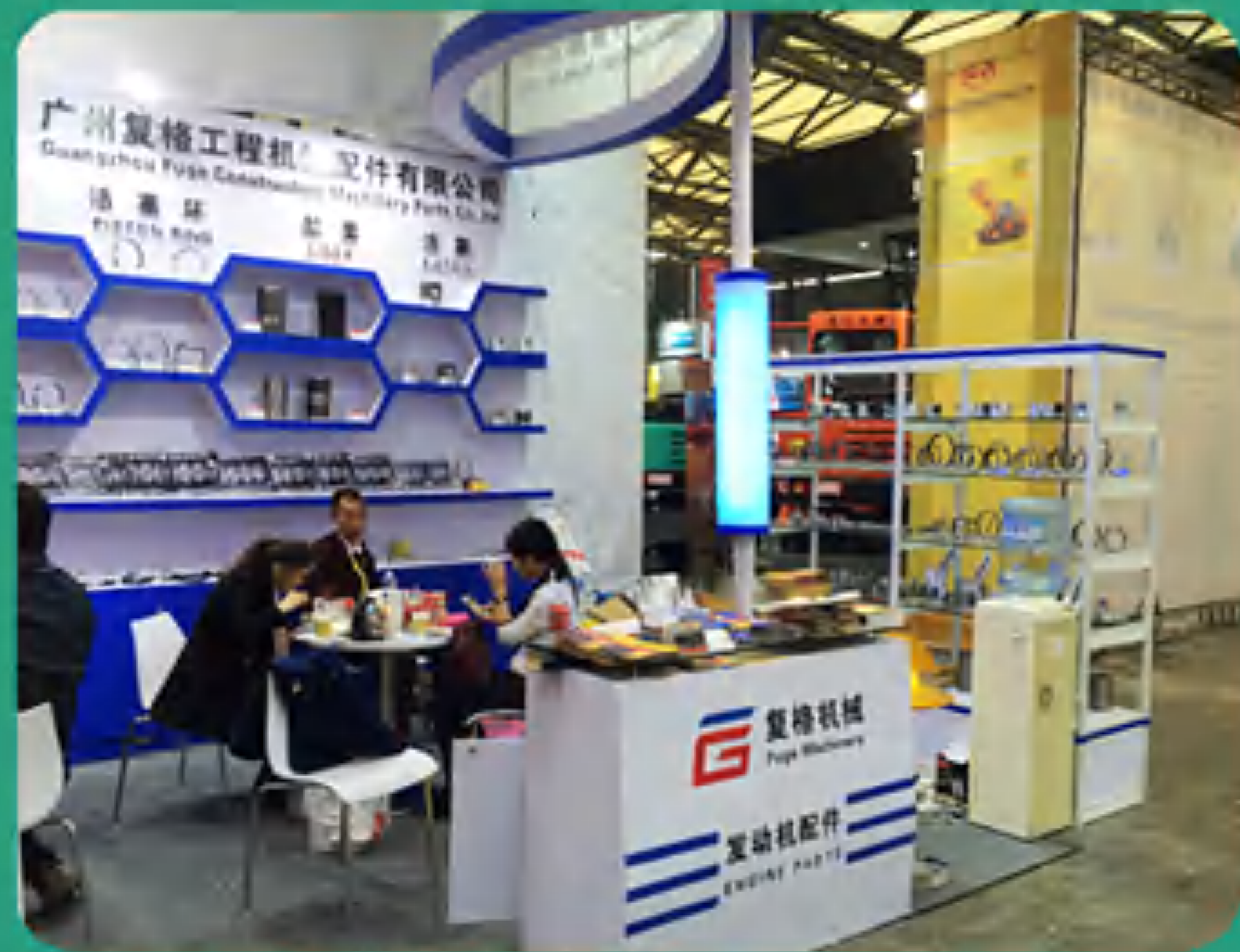

2014 - In India



2016 - In Germany



2020



2021



2018 - In India

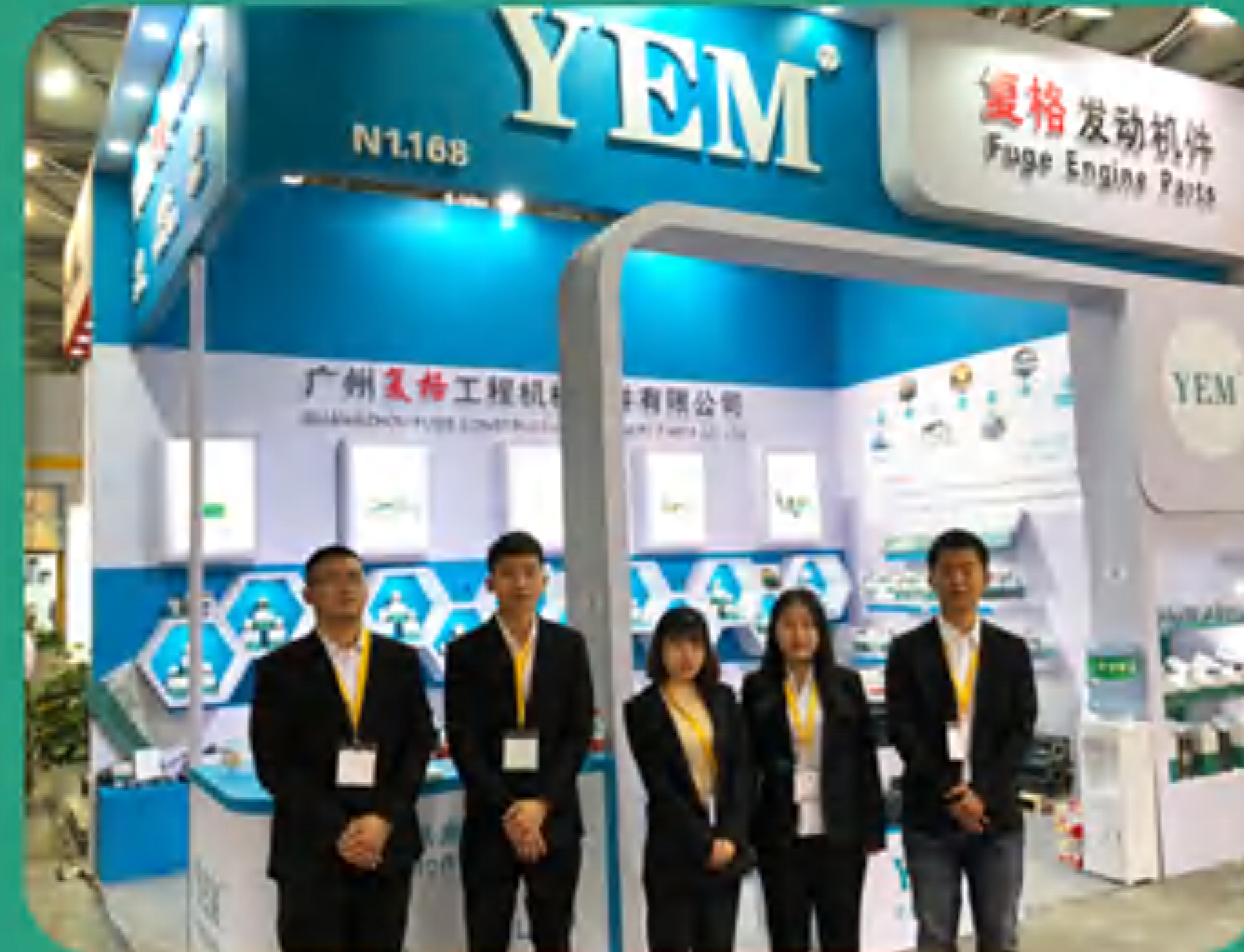

2020 - In Shanghai



2022



YEM, Team



浮动油封 FLOATING OIL SEAL.....001	气门弹簧 VALVE SPRING.....116
H连接胶系列 H COUPLING SERIES.....005	气门摇臂系列 ROCKER VALVE SERIES.....117
A、S连接胶系列 A.S COUPLING SERIES.....007	各种螺丝系列
连接胶通用表 COUPLING CATALOG.....009	CON ROD BOLT & CLY HEAD BOLT SERIES.....118
连接器系列 CONNECTOR SERIES.....010	发动机配件 ENGINE PARTS.....119
联轴器系列 COUPLING SERIES.....014	高压油泵 HIGH PRESSURE OIL PUMP.....121
肥仔胶 FATS GLUE.....017	喷油嘴 NOZZLE INJECTORS.....123
平行胶 PARALLEL GLUE.....017	高压共轨器 HIGH PRESSURE COMMON RAIL.....128
分油盅胶盖 OIL CUP RUBBER COVER.....017	喷油嘴铜套 RETAINING NUT NOZZLE.....129
机脚胶 ENGINE CUSHION.....018	卸压阀 PRESSURE RELIEF VALVE.....130
地板胶系列 FLOOR CUSHION SERIES.....024	EGR系列 EGR SERIES.....131
胶链板系列 RUBBER CHAIN SHOE.....026	增压器进油管 SUPERCHARGER INLET PIPE.....132
胶链条 RUBBER TRACK CHAIN.....026	喷油嘴回油管 NOZZLE RETURN PIPE.....134
皮带 BELT.....027	各类油管 ALL KINDS OF TUBING.....135
水管系列 HOSE SERIES.....028	高压油管 NOZZLE PIPING.....136
进气管 AIR FEEDER TUBE.....034	
O型圈 O-RING.....040	起动马达 STARTING MOTOR.....138
贴纸 STICKER.....042	发电机 ALTERNATOR.....144
斗轴油封 SEAL DUST.....043	增压器 TURBOCHARGER.....146
防尘圈 DUST WIPER.....043	水泵 WATER PUMP.....153
么盘胶条 VARIOUS OIL SEALS.....043	机油泵系列 OIL PUMP.....161
阻水圈 WATER SEALS FOR VARIOUS LINERS.....043	输油泵系列 FUEL INJECTION PUMP.....164
垫片 GASKET.....043	大修包 GASKET KIT.....166
排气管 EXHAUST PIPE.....044	汽缸床 GASKET HEAD.....168
皮带轮 PULLEY.....046	消声器 MUFFLER.....170
油门线 ACCELERATOR CABLE.....054	机油散热器盖 OIL COOLER COVER.....176
熄火线 STOP SWITCH WIRE.....054	气门室盖系列 COVER PLATE SERIES.....179
工具类 TOOLS.....056	机油散热器芯 OIL COOLER.....180
黄油枪 GREASE GUN.....057	机油格座 OIL FILTER HEAD.....182
灯具系列 LAMP SERIES.....058	柴油格座 FUEL FILTER HEAD.....185
表系列 METER.....062	节温器座 SEAT THERMOSTAT.....190
打链咀 ADJUST FITTING.....063	节温器 THERMASTAT.....191
黄油嘴 BUTTER MOUTH.....065	风叶系列 FAN COOLING.....192
万向节 UNIVERSAL COUPLING.....065	空滤总成 AIR FILTER ASS'Y.....197
盖类系列 TANK COVER SERIES.....066	后盖 FITER COVER.....197
付水箱 WIPER WATER TANK.....071	柴油箱滤网 FUEL TANK STRAINER.....199
锁系列 LOCK.....072	油水分离器系列 OIL-WATER SERIES.....200
油箱传感器 FUEL TANK SENSOR.....079	油水分离器杯 OIL SEP CUP.....203
油尺 HYDRAULIC OIL DIPSTICK.....080	
	电脑版控制器系列
发动机总成 ENGINE ASSY SERIES.....082	CONTROLLER/CONTROLLER SERIES.....204
缸体 CYLINDER BLOCK.....083	显示器系列 MONITOR.....208
缸盖 CYLINDER HEAD.....085	油门电机 THROTTLE MOTOR.....212
曲轴 CRANKSHAFT.....089	油门电机及配件
凸轮轴 CAMSHAFT.....094	THROTTLE MOTOR/AND PARTS.....216
连杆 CON-ROD.....096	油门旋钮 DIAL FUEL.....218
四配套 LINER KIT.....098	油门马达定位器 FITTING SENSOR.....220
活塞系列 PISTON SERIES.....100	电磁阀 SOLENOID.....221
活塞环系列 PISTON RING SERIES.....105	电磁阀线圈 SOLENOID VALVE COIL.....226
缸套系列 LINER SERIES.....108	电磁阀阀芯 SOLENOID VALVE CORE.....230
大小瓦 ENGINE BEARING.....112	压力传感器 PRESSURE SWITCH.....232
气门类 VALVES.....113	转速感应器 REVOLUTION SENSOR.....239
飞轮齿圈 FLY WHEEL GEAR RING.....114	水温感应器 WATER TEMP SENSOR.....242
机油喷嘴 NOZZLE.....116	

机油感应器 OIL PRESSURE SWITCH	245
熄火开关 FLAMEOUT SOLENOID	247
点火开关 VARIOUS LGNITION SWITCH	252
雨刮器总成 WIPER ASSY	255
雨刮片 WIPER BLADE	260
电器件 ELECTRIC PARTS	261
全车线束 WHOLE CAR WIRING HARNESS	264
插头系列 HARNESS SERIES	268

驾驶室 CAB	270
外罩系列 COVER SERIES	274
玻璃/天窗 GLASS,SKYLIGHTS	276
玻璃门框 EXCAVATOR GLASS	277
全车内饰 WHOLE CAR INTERIOR	278
装饰板 DECORATION BOARD	288
边门机盖系列 SIDE DOOR COVER SERIES	289
油封系列 SEAL KIT	292
杯士 BUSHING	299
轴承系列 BEARING SERIES	300
水箱 RADIATOR	304
液压油散热器 HYDRAULIC OIL COOLER	306
中冷器 INTERMEDIATE COOLER	308
压缩机系列 AIR COMPRESSOR	309
暖风电机 CONDENSER	313
电机总成 MOTOR ASSEMBLY	315
冷凝器 AIR CONDITION CONDENSOR	316
蒸发箱 COOLING RADIATOR	320
暖风小水箱 HEATING RADIATOR	322
膨胀阀 EXPANSION VALVE	324
干燥瓶 DRYING BOTTLE	325
空调滤芯 AIR PARTS	326
离合器线圈 CLUTCH COIL	328
其他空调件 OTHER AIR CONDITIONING PARTS	329
空调面板 AIR CONDITIONING PANEL	330

液压件系列 HYDRAULIC PUMP	334
调节器(提升器) REGULATOR	340
改装泵配件 REFIT PUMP FITTING	343
行走马达总成 TRAVEL MOTOR ASSY	344
行走马达总成通用表 TRAVEL MOTOR ASSY COMMON TABLE	349
行走牙箱 WALKING TOOTH BOX	351
行走马达盖 TRAVELLING MOTOR COVER	356
回转马达总成 ROTATE MOTOR ASSY	357
回转马达 ROTATE MOTOR	358
回转牙箱 ROTARY TOOTH BOX	360
牙箱总成 TOOTH BOX ASSY	364
回转牙箱外壳 ROTATING TOOTH BOX HOUSING	365
行走齿圈 WALKING RING	367
回转齿圈 ROTARY GEAR COMPONENTS	367
行走一二级总成 WALKING ONE OR TWO LEVEL ASSEMBLY	368

回转二级总成 ROTARY TWO STAGE ASSEMBLY	369
回转一级总成 ROTARY PRIMARY ASSEMBLY	370
回转立轴 ROTARY SHAFT COMPONENTS	370
分配器总成 DISTRIBUTOR ASSEMBLY	371
分配阀盖 DISTRIBUTING VALVE COVER	374
分油忠(回转接头)总成 OIL DISTRIBUTOR (ROTARY JOINT) ASSY	377
液压风扇泵 HYDRAULIC FAN PUMP	379
液压风扇马达 HYDRAULIC FAN MOTOR	380
风扇离合器/风扇支架 FAN CLUTCH/FAN SUPPORT	382
油源阀块 OIL SOURCE VALVE	384
先导泵/齿轮泵 THE PILOT GEAR PUMP	385

主炮、副炮 MAIN VALVE/SERVICE VALVE	411
单向阀 CHECK VALVE	417
摩擦片 FRICTION PLATE	423
脚踏阀 FOOT VALVE	433
操纵杆总成 LEVER VALVE ASSY	436
操纵杆子弹头 JOYSTICK PUSHER	441
行走子弹头 WALKING PUSHER	443
古田破碎锤 GL BREAKER	444

压管机 PIPE EXTRUDING MACHINE	455
压链机 CHAIN MAKING TOOLS	455
液压表及各种接头 HYDRAULIC GAUGE SET HOSE FITTING	455
油缸总成 JACK CYLINDER	456
活塞杆 PISTON	458
回转轴承 SWING BEARING	460
管路系列 LINE SERIES	461
链条 TRACK LINK	462
履带板 TRACK SHOE	463
引导轮 FRONT IDLER	464
支重轮 TRACK ROLLER	465
托链轮 CARRIER ROLLER	466
驱动齿 SPROCKET	467
千秋架 ROLLER CARRIER	468
护链架 ROLLER CARRIER	469
弹簧座 SPRING SEAT	469
弹簧 TRACK SPRING	470
弹簧总成 SPRING ASSEMBLY	471
涨紧油缸 ADJUST CYLINDER	472
挖斗 TEETH SEAT	475
高品质斗齿 TEETH AND TEETH SEAT	477
底盘件配件系列 CHASSIS PARTS ACCESSORIES SERIES	478
轮挖配件 LOADER SPARE PARTS	479
挖机模型 EXCAVATOR MODEL	482

液压泵 HYDRAULIC PUMP	486
微挖泵 MICRO-DIGGING PUMP	497
风扇泵 FAN PUMP	499
风扇马达 FAN MOTOR	501
回转装置(微挖) ROTARY DEVICE (MICRO EXCAVATION)	503
分油中 OIL SEPARATION	505
多路阀系列 MULTIWAY VALVE	507
液压件系列 HYDRAULIC PARTS SERIES	511
主炮/副炮 MAIN/SERVICE VALVE	517
单向阀 CHECK VALVE	520
手柄总成 HANDLE ASSEMBLY	524
脚踏阀 FOOT VALVE	526

NSK组件	528
起动马达 STARTING MOTOR	529
发电机 ALTERNATOR	533
水泵 WATER PUMP	535
柴油泵 DIESEL PUMP	538
喷油咀 INJECTOR ASSY	540
机油喷嘴 OIL NOZZLE	545
泄压阀 PRESSURE RELIEF VALVE	545
共轨总成 COMMON RAIL ASSEMBLY	546
输油泵 FUELINJECTION PUMP	547
散热器总成 OIL GOOLER ASSY	550
机油散热器边盖 OIL COOLER COVER	553
先导格座 FORERUNNER SEAT	555
柴油格座 FUEL FILTER HEAD	555
节温器座 SEAT THERMOSTAT	556
节温器 THERMOSTAT	557
进气铝管 AIRINTER TUBE	558
皮带轮系列 BELT TENSIONER	559
发动机零配件 ENGINE PARTS	563

油门电机 THROTTLE MOTOR	576
电脑版/控制面板 COMPUTER BOARD/CONTROL PANEL	579
检测仪 SURVEY METER/DETECTOR	581
点火开关 VARIOUS LGNITION SWITCH	582
熄火开关 FLAMEOUT SOLENOID	584
电磁阀 SOLENOID	587
转速感应器 REVOLUTION SENSOR	597
凸轮轴传感器 CAMSHAFT SENSOR	602
压力传感器 PRESSURE SWITCH	603
进气压力传感器 AIR PRESSURE SENSOR	607
机油感应器 OIL PRESSURE SWITCH	609

水温感应器 WATER TEMP SENSOR	614
电磁阀线圈 SOLENOID VALVE COIL	621
电磁阀阀芯 SOLENOID VALVE CORE	622
继电器系列 STARTER RELAY	623
微动开关 SWITCH ASS'Y	627
备用开关 SPARE SWITCH	628
插头系列 HARNESS SERIES	630
全车线束 WHOLE CAR WIRING HARNESS	634

盖类系列 TANK COVER SERIES	641
锁系列 LOCK	644
转向器 STEERING GEAR	649
油水分离器 OIL SEPARATOR	651
油水分离杯 OIL SEP CUP	653
滤网 STRAINER	654
倒车镜 REARVIEW MIRROR	655
雨刮电机系列 WIPER MOTOR	657
副水箱 TANK ASS'Y	658
油阀传感器 FUEL TANK SENSOR	659
撑杆 ARM-TIE	660
放油阀 OIL DRAIN VALVE	662
工具类 TOOLS	663
回油管 OIL RETURN TUBE	666
暖风电机 BLOWER MOTOR	670
空调系列 AIR CONDITIONING	670
空调管系列 PIPE TUBE ASSEMBLY	671

连接胶系列 COUPLING SERIES	673
连接器系列 CONNECTOR SERIES	675
联轴器系列 COUPLING SERIES	677
喇叭盘 TRUMPET PLATE	679
平行胶 PARALLEL GLUE	679
机脚胶 ENGINE CUSHION	680
减震胶 SHOCK ABSORPTION	684
水管 HOSE	686
耐油管 OIL PIPE	690
分水管 WATER PIPE	691
进气管 AIRDUST HOSE	693
排气管 EXHAUST PIPE	702
地板胶 CAB RUBBER CARPET	705
引导轮前叉 THE FRONT FORK - ILDER	714
车架总成 DERSRANLE ASSY	714
快换接头 QUICK CONVERSATION JOINT	715
抓木器 LOG GRAPPLE	715
振动夯 VIBRATING COMPACTOR	715

挖掘机机型&发动机型号对照表

KOMATSU 小松系列

机型	发动机型号	机型	发动机型号	机型	发动机型号
PC30	3D34	PC200-3旧	S6D105	PC300-3	S6D125-1
PC40	4D84	PC200-5	SA6D95L	PC300-5	S6D108-1
PC56-7	S4D87E-1	PC200-6	S6D95L	PC300-6	SAA6D108E-2
PC60-7	4D102	PC200-6(山推)	S6D102E-1-A	PC310	S6D108-1
PC60-8	SAA4D95LE-5	PC200-7	S6D102	PC350	S6D108-1
PC70-8	SAA4D95LE	PC200-8	SAA6D107E-1	PC300-7	6D114
PC100-1	S4D105-5	PC210-5	SA6D95L	PC360-7	6D114
PC100-3	6D95L	PC210-6	S6D95L	PC400-1	NT855
PC100-5	S4D95L-1	PC220-1	S6D105	PC400-3	S6D125-1
PC110-7	SAA4D95LE-3	PC220-2	S6D105	PC400-5	S6D125-1W
PC120-1	S4D105-5	PC220-3	S6D105-1	PC400-6	SA6D125E-2
PC120-3	6D95L	PC220-5	SA6D95L	PC400-8	SAA6D125E-5
PC120-5	S4D95L-1	PC220-6(山推)	SA6D102E-1-A	PC410	S6D125-1
PC130-7	SAA4D95LE-3	PC220-7	SA6D102E-1-A	PC450-8	SAA6D125E-5
PC150-1	6D105	PC230-6	SA6D95L	PC650-3	SA6D140
PC150-3	S6D95L	PC240LC-8	SA6D107E-1	PC710-5	SA6D104
PC200-1	6D105-1	PC300	N855	PC1000-1	S6D170B
PC200-2	S6D105	PC300-1	NT855		
PC200-3新	S6D105	PC300-2	NT855		

HITACHI 日立系列

机型	发动机型号	机型	发动机型号	机型	发动机型号
EX60-2	BD30	EX220	H06RCT	ZAX60	4JG1
EX90	4BD1	EX220-2	H06C-T	ZAX70	4JG1
EX100	4BD1	EX220-3	H06C-T	ZAX120	4BG1TC
EX100W	6BB1	EX270	H06CT-1	ZAX120-6	4BG1
EX100WD-2	6BB1	EX270-2	H06CT-1	ZAX200	6BG1T
EX100-2 4	4BD1-T1	EX300	EP100T	ZAX200-3G	AA-6WG1T
EX100-3	4BD1-T1	EX300-1	ERP100T	ZAX230-6	6BG1T
EX120	4BD1-T	EX300-2/3	6SD1-T	ZAX240-3	4HK1
EX120-2	4BD1-T	EX300-5	6BG1T	ZAX240-3G	AA-6WG1T
EX120-3	4BD1-T	EX400	6RB1-T	ZAX250-3	4HK1
EX120-5	4BG1	EX400-3	6RB1	ZAX330-3	6HK1
EX130	4BG1	EX400-5	6RB1	ZAX330-3G	AA-6HK1XQA
EX150	4BD1-T	UH-035/7	4BB1	ZAX350-3	6HK1
EX160WD	6BB1	UH04/2/5	6BB1	ZAX360-3G	AA-6HK1XQA
EX200-1旧	6BD1-T	UH05	EC100	ZAX360LC-3	AH-6HK1X
EX200-1	6BD1-T	UH055-7	6BB1	ZAX450-3	6WG1
EX200-2	6BD1-T	UH06	DA640	ZAX470-3	AH-6WG1XYSA-01
EX200-3	6BD1-T	UH06-5	6BD1		
EX200-5	6BG1	UH07-7	6BD1-T		

CATERPILLAR 卡特系列

机型	发动机型号	机型	发动机型号	机型	发动机型号
E40B	4D32	E300B	4SA1	E320B/BL	3166
E70	4D31	E450	6D22-TC	E320C/CL	S6KT
E70B	4D32	E650	S6B-TA	E322/322L	3116
E110	4D31T	E235B/C/D	3306	E325/325L	3116
E110B	S4K-T	E245B/D	3406	E325B/BL	3116
E120B	S4K-T	E307/C	3406	E325C	3116
E120/140	6D14	E311B	4D32	E330/330	3306
E180	6D14-T	E312C/CL	S4K	E330B/BL	3306
E200/B	S6K-T	E315C/CL	S4K	E330C	C9
E240	6D15-T	E318B	S4K	E345B	
E240B	3116-T	E320/320L 旧	3066	E350/350L	3306
E300	4SA1	E320/L新	3066	E375N	3406

KOBELCO 神钢系列

机型	发动机型号	机型	发动机型号	机型	发动机型号
SK60	4JB1	SK210-8	J05E	SK330-8	J08E
SK100	4BD1	SK230-6E	6D34T	SK350-6	6D34
SK120-3	4BD1T	SK250-6	6D16T	SK350-8	J08E
SK120-6	6D31T	SK250-8	J05E	SK400	6D22
SK200-3	6D31T	SK260-8	J05E	SK450-6	6D24T
SK200-5	6D15	SK300	6D22T	SK460-8	P11C
SK200-6	6D34T	SK330-6	6D16	Sk480-6	6D24

HYUNDAI 现代系列

机型	发动机型号	机型	发动机型号	机型	发动机型号
R55-7	4TNV94L	R215-7C	B5.9-C	R305LC-9	JQSB6.7
R55-7S	4TNV-94L	R215-9	D6BV-C	R335LC-7	C8.3-C
R60-7	4TNV-94L	R215-9C	B5.9-C	R335LC-9	QSC
R60-9新	4TNV-94L	R220-5	6BT5.9-C	R375LC-7H	D6AC-C
R80-7	4TNV-98	R225LC-7	B5.9-C	R385LC-9	QSC
R80-9新	4TNV-98	R225LC-9T新	B5.9-C	R455LC-7	QSM11-C
R130-5	4BT3.9	R260-5	6B5.9-C	R485LC-9	QSM11
R150LC-7	B3.9-C	R265LC-7	B5.9-C	R485LC-9T新	QSM11-C
R150LC-9新	B3.9-C	R265LC-9	QSB6.7	R505LC-7	QSM11-C
R200LC	D6BR	R275LC-9T新	C8.3-C	R515LC-9T新	QSM11-C
R200-5	6BT5.9-C	R300-5	6CT8.3	R805LC-7	QXS15
R215-7	D6BT-C	R305LC-7	C8.3-C		

KATO 加藤系列

机型	发动机型号	机型	发动机型号	机型	发动机型号
HD250	4D31	HD550SE	6D14C	HD900-2	6D14CT
HD250SE	S4F	HD550G	6DS70	HD900-5/7	6D15
HD300GS	6DS70	HD820-2	D31-T	HD1023	6D16
HD350G	6DS30	HD700SE	6D14CT	HD1100	NH220
HD400/450	6DS70	HD700G	6D11C	HD1200G	6D22RCT
HD400G	6DS70	HD700-5	6D31-T	HD1220SE	6D22RCT
HD500/550	6DS70	HD700-5新	6D31-T	HD1250SEV	6D22T
HD400SE	6D14	HD700-7	6D31-T	HD1250-7	6D22T
HD400SEV	4D31RCT	HD800-5/7	6D15	HD1430	6D24
HD400-5	6D31T	HD880	6D22	HD1500	NH220-V
HD450SE	6D31T	HD820	6D34	HD1800G	NH220-V
HD510	4D31-T	HD880SE-1/2	6D15RCT	HD1880SE	8DC9
Hd512	6D31-T	HD900SEV	6D15RCT		

SUMITOMO 住友系列

机型	发动机型号	机型	发动机型号	机型	发动机型号
SH45U	4D31	DH55	4JG1	EC55BLC	4TNV94
SH55	4JA1	DH60-7	4TNV94	EC140B	D4DEAE1
SH60	4JB1	DH130	DB58	EC210B	D6DEAE2
SH100	4BD1	DH170	6D16	EC240B	D7DEAE2
SH120	4BD1T	DH215-9E	DE08TIS	EC290BLC	D7DEAE2
SH145U	4D31T	DH220-3	D1146	EC360B	D10BEAE2 D12D
SH200	6BD1	DH220-5	DB58T	EC460B	D12D
SH200A3	6BG1T	DH220-9E	DE08TIS		
SH240-5	4HK1	DH258LC-V	D1146T		
SH300	D22T	DH280-3	D1146		
SH350	6D24	DH300-5	D1146T1		
SH350-5	6HK1	DH360-5	DE12T1		
SH400	6RB1	DH220-9E	DE08TIS		

DOOSAN 斗山宇系列

VOLVO 沃尔沃系列

浮动油封 FLOATING OIL SEAL

浮动油封 FLOATING OIL SEAL



YEM-H1



YEM-H2
客户定制



YEM-H3



YEM-H4



YEM-H5



YEM-H6
客户定制



YEM-H7



YEM-H8



YEM-H9



YEM-H10



YEM-H11



YEM-H12



YEM-H13



YEM-H14

序号	型号	OEM	内径	外径	组合尺寸	高度	适用机型
1	SG8170		817	865	870.6	46.5	
2	SG7780		780	836	841.9	80	
3	SG7770		770	826	831.9	80	
4	SG7740		740	801	816.9	80	
5	SG7718		718	750	762.2	50	
6	SG6670		667	700	705.6	50	
7	SG6660		660	695	705.3	53	
8	SG5960		596	628	613	43.6	
9	SG5910		591	623	635.2	50	
10	SG5880		580	608	613	43.6	
11	SG5590		559	590	602	50	
12	SG5550		555	590	595.5	42	
13	SG5380		538	580	585	60	
14	SG5300		530	560	572.2	50	
15	SG5080	568-33-00016/428-33-00022	508	548	554.4	60	HD785-5,D785-7,沃尔沃700
16	SG5050A		505	533.4	538.4	44	
17	SG5050	2979546 (3T6602/9W6644)	505	533.4	538.4	44	
18	SG4500		450	480	492.2	50	CAT345C,345D
19	SG441L		442	478	488.7	42	
20	SG4290	9W9230	429	457	462.3	38	CAT345C,345D
21	SG3870A		387	415	420.3	38	
22	SG3870	JB5895/14579901	387	415	419.5	38	VOLVO360, VOLVO290, 460,DH500.DX500

序号	型号	OEM	内径	外径	组合尺寸	高度	适用机型
23	SG3800	287-33-00010/425-33-00111/208-27-00210	380.5	405	412.2	40	PC/400, PC/400-5/6/7.PC300-3,PC450-6/7/8.R370-7另一款
24	SG378L		378	414	424.1	42	
25	SG3700		370	398	403.5	38	
26	SG3662	5P6418	366	394	399.5	46	
27	SG3660		366	394	399.5	38	
28	SG3660=3650	175-27-00130/XKAQ-00173/4344155/9G5323	366	394	400.3	38	SK300, 300-3;SH300,340.350;E330BCD; EX350-5.400,400-3/5.EX450-3.EX470;R290, DH280,300 ,HD1430,1880. ZAX470.ZAX360电喷 R285.290.375.R370-7一款.DH420,280,300-5,300-7,370-7.
29	SG3560	17M-27-00102	356	381	389.5	38	
30	SG3500		350	375	385.5	38	
31	SG3400	170-27-00020/00025/207-27-00310/421-33-00020	338	368	375	40	PC/200-6(山推机型) E330B,220-6,300-6; DH/220-5;SK/200-3,200-6E.EX400-1, PC220-6,E450,PC300-5/6/7,PC360-7, PC350-6-8,EX300(少部分),SK320-6,SK330,R260-5,DH215-7,230-6摆线,三一 SY335.LS350-5.SK350-8.SK350超8
32	SG3350		335	368	374.7	40	
33	SG3350	150-27-00020	335	368	373	40	神钢/SK-330-6/8. DH370/420/420-7
34	SG3220		322	346	351.6	38	
35	SG3210		321	346	351.5	38	
36	SG3200L		320	352	365.1	40	
37	SG3180A		318	341	351.6	38	
38	SG3180		318	346	352	38	
39	SG3180	5M7294/207-1571	318	346.5	351.6	38	VLV210, E324/325 ,JCM921C.众友921,改版 TM35总成 利勃海尔914.924. EC210B,240B, DH225-9.R215-9.R215-7摆线
40	SG3090		309	337	341	40	
41	SG3050		305	328	333	38	
42	SG3030		303	328	334	38	
43	SG3020		302	330	336.6	34	
44	SG3003		300	325	333	38	
45	SG3002		300	325	336	38	
46	SG3001A		300	328	333	40.8	
47	SG3001		300	328	333	40	
48	SG2981		298	328	332.75	40.8	
49	SG3000A		298	328	332	40.8	
50	SG2980=3000	114-1497/150-27-00025/4066695/174-4874	298	328	333	42	PC200-3\5,E240,ZAX360直喷 EX300-2/1/3/5;SK200,200-5,220-5, 230-6齿轮,250-8,330,E320B/C/D,E200B.HD820,HD700SEV; SH200;UH07-5,UH07-7, UH083;SH210-5电喷 ZAX330, EX300-5,PC150-5,C290,D60,DH300-7新款 SK07-2,SH280FJ2,DH220-7(摆线);HD700-5/7, H820-3, SK350-8,三一SY 215,PC220-7, 凯斯 210.240.SHA1.A2玉柴230(KYB)
51	SG2940	150-27-00410/20Y-27-00450	294	328	333	40	PC200-7/8;夏工822, HD-820-1/2,PC220-8, 210-8.SK250-8. PC160-7 山河智能230.三一
52	SG284AB		250	277	284.6	22	PC/100-5, 120-5 齿轮; HD/400,450-7; SK/100, SK100-1,LS2800FJ,HD770SELL, HD800SEV (SOME PART)
53			247	284		13.3	

浮动油封 FLOATING OIL SEAL

序号	型号	OEM	内径	外径	组合尺寸	高度	适用机型
54	SG2820	39Q6-42130	282	314	320.5	40	新款R215-7S
55	SG2800=2780	YN53D00008S023	280	310	315.5	40	SK210-6E.SK/200-6E进口机; DH/225-7
56	SG2770		277	297	301	30	
57	SG2750A		275	303	308	36	
58	SG2750	GZ5845	275	303	308	38	EC240B(新款) SK200-7,SK/200-6;
59	SG2720A		272	300	305	40	
60	SG2720		272	300	306	40	
61	SG2720		272	300	304	40	
62	SG2650B		265	293	298.5	38	
63	SG2650A	6P3595	265	292	298.5	44	
64	SG2650	5M1177	265	293	298	38	HD1250VII,HD800VII1250-7.900-7/5,220SEII;HD800-7. E311.E315,E331C,E-312,E120B 厦工/820;R200,210,220,220-5-7,215-7齿 轮,225-7.R260-5齿轮 DH225-7.DH230-7DH220-3-7 SH265,260.SK200-8.SK250超8 力士德210/DH210-7/SY210-8(第星)
65	SG2620	LQ15V00031R200	262	290	298	38	
66	SG260AB		209	234	242.6	21	HD700-2,HD40056-72,D60-12,HD700SEII, HD400SEV(单边) HD450-5,EX120-3,PC100-3,PC120-3
			216	260		13.5	
67	SG2600A		260	288	298	40	神钢/SK210-8
68	SG2600	14X-27-00100/566-33-00010	260	288	295	40	神钢/SK200-超8.SK260-超8
69	SG2520		252	280	286.5	38	
70	SG2500B		250	270	274.7	30	
71	SG2500A		250	270	274.7	30	
72	SG2500		250	277	285.6	44	
73	SG2500		250	277	284.6	43	
74	SG2500	4514259	250	277	284.6	44	EX/200-1;HD/800-5,1250-5;R130,众友913 R150.PC120-6(大机头),SH120,UH-081; HD400VII,HD850G,HD1220SEII; SK120-3. DH150-7,PC130-7 ZX110M ZX160-1 EX135-
75	SG249AB		250	277	284.6	22	PC/100-6, ;LS120 ; SK/120, SK100-2,SH120,PC120-6(小机头) ,HD512
			248	290		13	
76	SG2460L型		246	270		40	
77	SG245AB		209	234	243.2	21	
			216	245		10.5	
78	SG2451		245	264.5	269	32	
79	SG2450A		245	264.5	269	32	
80	SG2450	20Y-27-41210/20Y-27-00110	245	274	278	42	PC200-8混合动力
81	SG2410A		241	268.5	273.5	38	
	SG2410C		241	262.7	274	39	
82	SG2410		241	262.7	274	39	DS150-9.徐工135.山河150.EC140
83	SG2400		240	262.8	273.5	38	
84	SG2400	20Y-27-00111	239	268	277	40	PC200-8混合动力
85	SG2390A		239	268	273	42	

浮动油封 FLOATING OIL SEAL

序号	型号	OEM	内径	外径	组合尺寸	高度	适用机型
86	SG2390		239	268	274.2	42	
	SG2390		240	263	273.5	38	
87	SG2390	141-27-00100/4634693/4114753/20Y-27-00140	239	268	274.2	42	EX/200-2/3/5,EX220-2;LS2800, ZAX200;SH200.EX210-5.EC140
88	SG2380A		238	261	265.7	31.8	
89	SG2380		238	261	265.5	32	
90	SG2350	A235000	235	265	274.6	42	ZAX200-3电喷.210-3.240-3
91	SG2340		234	260	264	36	
92	SG2330L		233.5	259		36	
93	SG2330		233	260	266	36	
94	SG2320		232	260	265	36	
95	SG2310	5P5829	231.6	259.6	265	38	神钢/SK200-8一款
96	SG2300		230	260	266	36	
97	SG2270L型		227	260		41	
98	SG225AB		225	253	258	18.5	YC85 (KYB)
			222	254.7		11	
99	SG2250A		225	252	258.3	38	
100	SG2250	130-27-00010	225	253	258	37	PC120-5(摆线)
101	SG2236		223.5	251.4	257	38	
102	SG2235	8P1252	223.5	251.5	257.2	46.4	HD/55
103	SG2230		223	251	257	44.4	
104	SG2230	5M8647	223	251	256.6	38	ZAX/EX120-2,100-5,D50; SH75. ZAX120-6
105	SG2225A		223	251.5	257.2	46	
106	SG2225		222.5	246	249.6	36	
107	SG2220		222	246	251.8	36	
108	SG2200M		220	240	244	32	
109	SG2200K		220	246	251.3	36	
110	SG2200J		220	241.5	244.7	25	
	SG2200A		220	239.3	244.5	32	
111	SG2200H		220	239.5	244.4	31.8	
112	SG2200G		220	239.5	244	31.8	
113	SG2200F		220	241.5	244.7	25	
114	SG2200E		220	240	245.3	26	
115	SG2200D		220	241.2	245.7	25	
116	SG2200B		220	246	254.6	41	
117	SG2200B		220	246	254.6	41	
118	SG2200A		220	239.3	243.8	32	
119	SG2200A	GZ5880	220	239.3	244.5	32	三一75的一款.TM18总成
120	SG2200(加高)		220	246	254.6	41	ZAX/EX/100, 110.120-2, 120-5; SH/75
121	SG2200C		220	246	253.3	36	
122	SC2200A		220	240		32	
123	SG2200	HIT4110369	220	246	256	36	ZAX/EX/100, 110.120-2, 120-5; SH/75.
124	SG220AB		220	246	256	18	
			225	260		13	
125	SG217 (0004A)		217	237	241.5	30	

浮动油封 FLOATING OIL SEAL

序号	型号	OEM	内径	外径	组合尺寸	高度	适用机型
126	SG2170		217	237	242.3	30	
127	SG2160		216	230	235.3	27.3	
128	SG2090	HIT4110368	209	234	242.6	42	SH130-5.SK140-8.EC80
129	SG2050F		205	227	231.5	30	
130	SG2050E		205	227	231.8	30	
131	SG2050D		205	227	232	30	
132	SG2050B		205	227	231.2	30	
133	SG2050A		205	227	231.5	30	
134	SG2050C		205	227	231.5	31	
135	SG2050A		205	227	231.5	30	
136	SC2050A		205	227	231.5	30	
137	SG2050	GZ5820	205	227	231.2	30	PC60-7.石川岛60.玉柴85-7-8一款. SH75一款. 三一75-8-9.CAT307-308一款 久保田185,YC85,柳工907,柳工80
138	SG2020		202	222.3	224.9	26.5	
139	SG2000		200	228.5	233.5	38	
140	SG2000A		200	228.5	233.5	38	
141	SG2000		200	230		13	
142	SG1980		198	228	233.5	39	
143	SG1950		195	216.5	221	32	
144	SG1920D		192	215	222.8	33	
145	SG1920C		192	215	221.1	33	
146	SG1920		192	215	221	33	
147	SG1920	207-27-00010	192	215	220.8	33	R60;PC300-1/2;DH60,DH80.DH55,EC55; EX/70,ZAX55/70, SH60;HD250,E70. 临工65.山河70/雷沃60.65KYB马达《9孔》
148	SG192AB		192	215	220.8	16.5	PC/60-5/6 E70B , PC/60-7(山推); SH/60 ,160; SK60-1/-2-3,DH55, PC1000,EX90;HD307,250
149	SG1910		191	210	214	28	
150	SG1910		191	209.7	214.6	29	CAT306E
151	SG1910		191	210	214	28	
152	SG1890		189	205	211	28.4	E55.E60.ZAX60.GCB8052.CAT306.SK75. 玉柴65.雷沃60.65KYB马达《12孔》长野55 E305.5 玉柴开元60-7(KYB)
153	SG1880B		188	216.5	227	38	
154	SG1880A		188	205	211	28	
155	SG1890		189	205	211	28.4	
156	SG1880		188	205	211	28.4	
157	SG1860		186	203	205.7	25.4	
158	SG1830A		183	202	206.2	28	
159	SG1830		183	202	206	28	
160	SG1825	8P1848/9W674	182.5	210.3	215.4	46	
161	SG1820B		182	210.5	215.5	38	
162	SG1820A		182	210.5	215.5	38	
163	SG1820		182	210	215.8	38	
164	SG1820	5M1176 9W6671/6T-8439	182	210	215.2	39	CAT-229D、LC,229,231D-LC,235.L PC200-1/2;EX60-1,EX75UR, EX60,D60,EX60-2

浮动油封 FLOATING OIL SEAL

序号	型号	OEM	内径	外径	组合尺寸	高度	适用机型
165	SG180H		180	203		10	
166	SG1800		180	197.4	202.2	21.4	
167	SG1781		178	200	210.6	38	驱动桥专用
168	SG1780D		178	200	204.5	38	
169	SG1780		178	200	212	38	
170	SG1780	4513173	178	200	210.6	38	PC/50, PC40.山河智能50
171	SG1780A		177.5	200	204.1	32	雷沃60.65-7.康迈尔马达
172	SG1780D		178	200	204.5	38	
173	SG178AB		182.6	210		11.2	
174	SG1770		178	200	210.6	19	
175	SG1760		177	200	204.5	31	
176	SG1750=1760		176	194.5	200	28	玉柴60-8/SH山河70/SK55-C/福田雷沃60.65/三一65.三一75(力士乐)
177	SG1740		175	194.5	200	28	
178	SG1740		174	190	192.7	25.4	
179	SG1720		171.5	194.5	200	29	SH山河70/SK55/福田60/三一75(力士乐).龙宫60
180	SG169L		169	195	205.5	33	
181	SG1690		169	189	193.5	32	
182	SG1680		168	185	190	21	
183	SG1650F		165	194	198.5	38	
184	SG1650E		165	181	184	27	
185	SG1650D		165	181	185	27	
186	SG1650C		165	180.5	185.5	27	
187	SG1650B		165	180.5	185	27	
188	SG1650A		165	180.5	185	27	
189	SG1650		165	183	188.6	29.8	山河智能70, 玉柴60/60-6(帝人马达)
190	SG1640C		164	189	194	28	
191	SG1640		164	189	193.5	30	
192	SG1631	8P1857/9W7332	163	191	196.8	46	
193	SG1630D		163.5	191.5	197	38	
194	SG1630C		163	191.5	196.6	38	
195	SG1630		163	191	196.8	38	
196	SG1630	7M0481/9G5313/9W6668/9W6669	163	191	196.4	38	
197	SG163AB		163	191	197	19	SK04
198	SG1630		163	191	196.8	38	
199	SG1601		160	180	186.3	29	
200	SG1601		160	180	186.3	32	
201	SG1600A		160	180	186.3	32	
202	SG1600		160	180	186	32	
203	SG1600	180-27-00021	160	180	185.6	32	PC40-9.PC55/56, 玉柴55.60开元60(不二越马达) 久宝田161,PC35-6(不二越500马达)
204	SG1550		155	177	181.5	38	
205	SG1540H		154	178	181	34	
206	SG1540F		154	168	171	27	
207	SG1540E		154	170	175.6	21.5	
208	SG1540D		154	169	174.5	22	

浮动油封 FLOATING OIL SEAL

序号	型号	OEM	内径	外径	组合尺寸	高度	适用机型
207	SG1540C		154	170	175.1	21	
208	SG154AB		166	184		10	
			154	174	178	16	
209	SG1540A		154	174	178	32	
210	SG1540		154	168	171	25.4	
211	SG1540		154	168	171	27	
212	SG1540		154	168	171.6	26.4	
213	SG1540	5K1078/9W7211	154	168	171.6	26.4	SH山河40/玉柴35(KYB)
214	SG1540		154	168	171	12.7	
215	SG1530A		153	171.5	176.3	28	
216	SG1530		154	173	178	33	
217	SG1501		150	171	175.5	32	
218	SG150AB		150	171.7	179	20	
			160	180		11	
219	SG150A		150	171	179	20	
220	SG150B		160	180		11	
221	SG1500F		150	171		32	
222	SG1500E		150	172	176	40	
223	SG1500D		150	171	175.6	32	
224	SG1500C		150	171	175.3	32	
225	SG1500B		150	171	175.6	32	
226	SG1500		150	171	175.5	32	
227	SG1500		150	171.7	179	40	
228	SG149L		149	168	187.8	30	
229	SG1490		150	168	173.8	34	
230	SG1480A		148	170	175.6	31	
231	SG1480		148	171	175.2	32	
232	SG171		150	171	176	32	
233	SG171		150	171	175.4	32	
234	SG1480	175-27-00121	148.5	170.8	176	32	PC30-7/8,PC35.YC35(不二越390)原装铁片尺寸是151*171
235	SG1470C		147	160	165.5	21	
236	SG1470B		147	160	165.6	22	
237	SG1470A		147	167	171	28	
238	SG1470		147	160	165.6	22	
239	SG1470		147	160	165.5	22	
240	SG1460C		146	168	171	34	
241	SG1460B		146	172	177	38	
242	SG1460A		146	168	171	34	
243	SG1460		146	170	177.5	39	
244	SG1460	4K6049/9W6666	146.5	171.5	176.7	38	
245	SG1430C		143	157	164	27	
246	SG1430B		143	160	165	28	
247	SG1430A		143	157	160	27	
248	SG1430	5K5288	143	156.2	160.4	26	
249	SG143		143	157	159.8	25.4	

浮动油封 FLOATING OIL SEAL

序号	型号	OEM	内径	外径	组合尺寸	高度	适用机型
250	SG1427		142.7	156.9	159.7	25.4	
251	SG140AB		140	155	159	13	
			147	165		8	
252	SG140A		141	155	160.4	13	
253	SG140B		147	165		8	
254	SG1400		140	155	158.6	26	
255	SG1370	4642180	137	153	162.4	31	
256	SG1310		131	151	156	30	
257	SG1300B		130	150.5	155.6	32	
258	SG1300A		130	152	159	38	
259	SG1300	170-27-00010	130	151	156.8	32	
260	SG130-16		130	151	156	32	
261	SG150		130	150	155.5	32	
262	SG127D		127	146	151	32	
263	SC1270C		127	141		28	
264	SG1270B		127	141	144	26	
265	SG1270D		127	141.2	143.8	25.4	
266	SG1270	1P7249	127	146	151	32	
267	SG1240A		124	141	146.4	22	
268	SG1240		124	141	146	22	
269	SG1240	207-30-00101	124	141.2	146	22	
270	SGXY型油封		136.3	123.5		8	
			123.5	136.3	140.7	8	
271	SG123		123	141		8	
272	SG121		121	138.5	143.5	32	
273	SG1200C		120	139	143	32	
274	SG1200		120	143	149.5	38	
275	SG1160		116	137	141.5	31	
276	SG1151		115	130	134.6	20	
277	SG137(008B)		115	137	142.6	32	
278	SG137(005B)		115	137	142.8	32	
279	SG137		115	137	142	32	
280	SG137		115	137	141.3	32	
281	SG137		115	137	142	32	
282	SG137		115	137	143	32	
283	SG1150		115	137	142.5	31	
284	SG1150	150-27-00015	115	137	142.5	31	D6驱小, EX400支重轮
285	SG115 (137)		115	137	141.6	32	
286	SG1145A		114.5	129	133.5	22	
287	SG1145		114.5	129	134.1	21	
288	SG1140A		114	137	141.9	31	
289	SG1120		112	128	132.5	22	
290	SG(008B)		109	127	133.1	32	
291	SG127		109	127	132.5	32	
292	SG1270D		110	127	133	32	

浮动油封 FLOATING OIL SEAL

序号	型号	OEM	内径	外径	组合尺寸	高度	适用机型
293	SG1100C		109	127	130.6	32	
294	SG1100A	4508193	110	128	133	32	
295	SG1100B		109	126.7	134.7	32	
296	SG110 (128)		110	128	133.5	32	
297	SG1090A		110	132.2	137.2	28	
298	SG1090	130-27-00020	109	132.2	137.2	32	NEW PRODUCT 新产品
299	SG1080		108	122	125.8	22	
300	SG1070 (XY油封)		117.7	107		6.9	
			107	117.7	121.5	6.9	
301	SG106L		105.6	126	133.5	24.6	
302	SG1042	20Y-30-00101	104.2	121	126	23.4	
303	SG1040D		104	122	125.8	22	
304	SG1040C		104	117	121	22	
305	SG1040A		104	122.5	125.5	22.5	
306	SG1039	20Y-30-00100	104	117	122	22	
307	SG1020A		102	117	121.6	21	
308	SG1020D		102	117	122.5	21	
309	SG1020	205-30-00050	102	122	127	33	
310	SG102-14		102	119	124	29	
311	SG101.5		101.5	117	122.3	21.6	
312	SG1010A		100	117	121	21	
313	SG1010	205-30-00052	101	120	125	30.2	
314	SG1000C		100	119	123.2	31.8	
315	SG1000		100	119	123	31.8	
316	SG1000 (1200)	1M8748/5P0204/9W7225	100	120	124.2	32	
317	SC1000		100	119		32	
318	SG119.1		100	119.1		31.8	
319	SG120B		99	120	124.1	32	
320	SG990		99	120	125	32	
321	SG120(005B)		100	120	124.2	32	
322	SG120(011B)		100	120	124.3	32	
323	SG120(013B)		100	120	124	32	
324	SG120		100	120	124.1	32	
325	SG120(008B)		100	120	124.3	32	
326	SG120(015B)		100	120	124.3	32	
327	SG985		98.5	119	123.5	30	
328	SG0965		96.5	106.6	109.7	13.6	
329	SG950	HIT 4110360	95	114	119.5	32	
330	SG0940A		94	106.5	111.5	23	
331	SG940	20Y-30-00040	94	107	112	21.8	334.8
332	SG1095A		90.5	109.5		31.8	
333	SG109C		90.5	109	112.8	32	
334	SG90 (109D)		90	109	113.4	32	
335	SG90 (109B)		90	109	113	32	
336	SG920 (109)	20Y-30-00041	92	109	114.2	22	

浮动油封 FLOATING OIL SEAL

序号	型号	OEM	内径	外径	组合尺寸	高度	适用机型
337	SG920A		92	109.5	113.8	22	
338	SG910 (1100)	1M8746/9W7220/4047279	91	110	114.1	32	HD450引
339	SG110		90	110	114.5	32	
340	SG110(009B)		90	110	114	32	
341	SG110		91	110	114.1	32	
342	SG110(010B)		90	110	114.3	32	
343	SG110		90	110	114.2	32	
344	SG905		90.5	109	114	33	
345	SG0905		90.5	109.6	114.5	32	
346	SG900A		90	105	107.3	26	
347	SG900	6S3285	90	105	107.5	26	
348	SG900B		91	110	113.5	32	
349	SG0890B		88.8	106.5	111.5	23	
350	SG86 (105)		86	105	109	30	
351	SG850		85	104.3	107.4	32	
352	SG0820A		96	82		10.5	
353	SGX8		96	83.8		9.5	
354	SG820		82	102	105.5	32	
355	SG0820		82	98	102.4	25.6	
356	SG0810		81	100	105	30	
357	SG810	175-30-00702	80	100	105.5	29	PC100支
358	SG1000B		80	100	105.5	30	
359	SG100A		80	100	105	30	
360	SG770		76	94	101.5	29.6	
361	SG770	150-30-00035/9W6651	77	93.3	100.5	30	
362	SG93A		76	93.3		29	
363	SG0760		76	94	101	29	
364	SG93B		74.6	93	100.8	29	
365	SG746		74.6	93	100.1	30	
366	SG0740C		74	93.5	105	29	
367	SG740		74	87	91.6	21.6	HD250支, D50
368	SG737	20Y-30-00070	73.7	87	92	21.5	
369	SG735L		73.5	93.6	101.5	20	
370	SG735L		73.5	93		20	
371	SG730	1M8747/9W6647	73	92	96.5	32.5	
372	SG89A		72	89	93	24	
373	SG0710B		71.7	90	96.5	28	
374	SG710B		71.7	90	96.5	28	
375	SG710	141-30-00610	71.7	90	95.5	29	HD250引, A60,D50
376	SG90C		70	90	95.3	28	
377	SG90A		70	90	95.5	28	
378	SG90		70	90	96.3	28	
379	SG90		70	90	95	29	
380	SG900D		70	90	95.5	28	
381	SG0690		69	84		24	

浮动油封 FLOATING OIL SEAL

序号	型号	OEM	内径	外径	组合尺寸	高度	适用机型
382	SG690	7T4080/9W7232	69	84.5	90	26	
383	SG690		69	84	89.6	24	
384	SG0650		65	75	79	16	
385	SG78		64	78	83.2	25.4	
386	SG78		64	78	83	25.4	
387	SG0640A		64	78		25	
388	SG640	4110359	64	78	84.3	25	
389	SG635	2M2858/9W7216	63.5	82.5	86.5	32.3	CAT-2M 2858/
390	SG620		62	73.5	78	16	
391	SG0580C		58	71	75	13.8	
392	SG74(010B)		58	74	79	25	
393	SG580	140-30-00040	58	74	79.3	25	YC85,E120B,SK100托轮
394	SG74		58	74	79.2	25	
395	SG0560A		56	70	78	23.2	
396	SG560	4128201	56	70	76.2	25.5	
397	SG554 (XY型油封)		55.4	64.7		4.7	
			64.7	55.4		5.41	
398	SG54 (70)		54	70	76.8	25	
399	SG530L		53.1	67	76.3	16.8	
400	SG510		51	65	68.5	27	
401	SG500L		50.5	62.7		16.6	
402	SG48 (62)		48	62	68.3	25	
403	SG480	HIT4110358	48	62	68.5	24.8	
404	SG0460L		46.5	59	66.3	19	
405	SG60		46	60	64.3	24	
406	SG60		46	60	64	24	
407	SG0460		46	60	52.55	12	
408	SG450	110-30-00045	45	58	61.6	21	
409	SG430	110-30-00085/86	43	58	62	24	
410	SG380		38	54		10.6	
411	SG101.5		101.5	117	122.3	10.8	图纸有



H连接胶系列 HCOUPLING SERIES

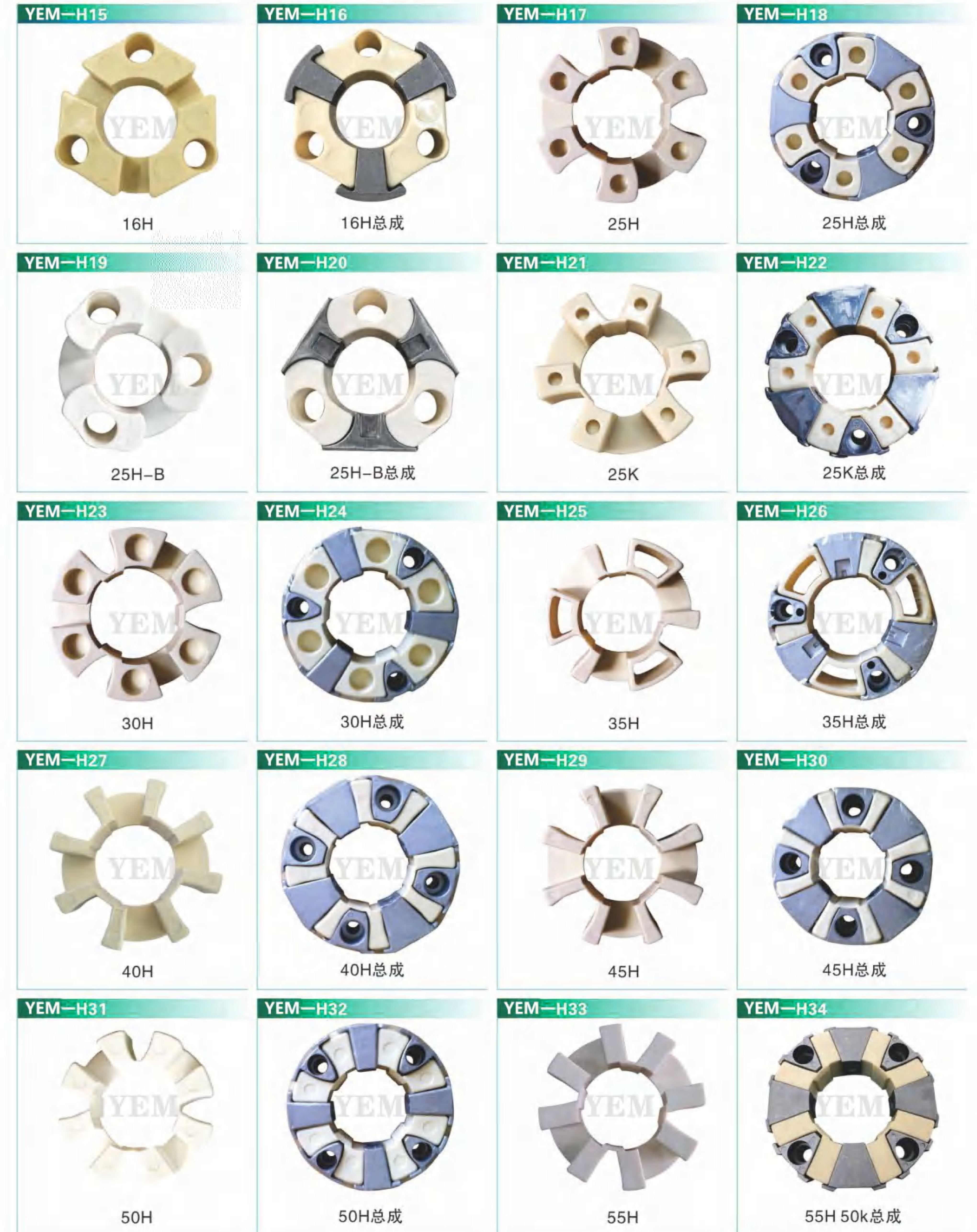

H连接胶系列 HCOUPLING SERIES

A、S连接胶系列 AS COUPLING SERIES



A、S连接胶系列 AS COUPLING SERIES

连接胶通用表 COUPLING CATALOG

























型号	50A	30A	28AS	25A	140A	50ASM	35H	110H	160H	50H	25K
E120/120B	SK04	EX120-2	VOLVO55	SH300	LS280FJ2	ZAX120/120-7	徐工370	R335-7	PC200-1/2	厦工806	
E311/E111B	SK100-6/5		SH75			EX120-6	HD1023	R305-7/290-3	PC220-2	R60-9	
E312/E312B	EX60-1		EX50			EX130-6	HD1430	LS580	HD700-1/2/5		
HD450-7	EX90-1		EX100			ZAX55/80	DX260	LS430	HD800-5/7		
HD400-7	E708		石川岛55			ZAX70	E320D	SK300/320	HD850		
HD512-3	E307/E307B		SK100-3			SK55	E324D	SK330B/330B	HD900-5/7		
SH200A1A2A3	E305.5		EX200-3			DH80-5	EX210-7	SK330-6-8	HD850		
SH260	SK60-5					ZAX60	EX270	SK350-8	EX200-1-5		
SH265	HD250						EX300-1/2/3	E330B/330D	EX220-1/5		
SK185	HD2550-5/7						EX350-3-5	EC290/360B	UH07-7		
	E307C						ZAX330-3	R365-9	SK200-1/3/5		
	HD307						E325C	ZAX360-3	SK210-8		
							E240B	DH225-9	E320		
							SK230	DH280/300/350	SY135		
							VOLVO210	SH300-7	E320B/C/D		
							R225-7	YC450	E325		
							SK220-3	E3306D	DH220-3/5		
							EX330	SK400	DH225-7		
							SK260	EX350-7	SH30-5		
							山重921	R305-7	R200-5		
							三一285	R290-7	R210-5		
							三一365-8		R215-7		
							YC230-8改14T		R220-5		
									R260		
									DH150		
									SK250-6		
									厦工820		
									volvo140		
									柳工200-3		
									柳工225		
									DH220-9		
									EX230		
									雷沃260		
									临工210		
									SK135		
									三一215/235-8		
型号	240K	30H	50AS	30AS	22AS	25AS	8A	16AS	40H	50K	80A
R520-9	DH55/80-7	HD250SE	SH65	SK55	R55/SH60	PC20/30/38	PC30-5/35-8	SH210	R110-7	JCB200	
R520-9	嘉禾85	HD250-2	SK03-2	SH75			PC40/40-6	EX200-2	R215-7	JCB220	
	SK60-2/5	HD400	SK60-1-2-3	R60-5/7			PC50BC	EX210-5	力士德130-7		
	JCM913	HD450	HD250-7	EX55			PC70	EX120-2/5-3	宜工230		
	SK100-6	HD510	HD307	石川岛60-7			EX55	EX100-2			
	R60-9	EX100-1	SK100-3	SK50			ZAX55	EX130-2			
		EX160	EX60-3				PC56-7	EX200-5			
		EX120-1	E307/E308				久保田163				
		EX150	SK60-6								
		EX130-1	SK75								
		EX90-1	久保田185								
		SH100									
		SH130-5									
		SK135									
		SH120A1									
型号	50AC	28A	16A	YC35	Sh15齿	25H	45H	140H	240H	110K	90H
14齿	EX100-2-3	SK03/04	E304/305	SH60	DH50/55	EX200-3/6	DH280-3	SK450-6	R250-7	SK230-6E	
E200B	EX120-2-5	ZAX55/EX55	E303	HD305	R80	ZAX200/230	PC300-1	R385-7		SK250-8	
E270B	E110	PC30-8	YC35-6		R55	EX210	SK07-09	E345B		SK200-6E	
E180					ZAX55	ZAX210	SK350-8	SK480		SK260-8	
HD800-2						ZAX270	HD1880	ZAX470 直喷		DH300-5-7	
SH200A1A2A3						ZAX240-3	E300B/330			R210	
SH123						SK200-6	E330C			R230-8	
						SK210-6	SH430/450			R200-8	
						SH245	R360				
						SH210-5	三一335				

<p>YEM-H95</p>  <p>168 26T 3H</p>	<p>YEM-H96</p>  <p>200 50T 4H</p>	<p>YEM-H97</p>  <p>264 42T 6H</p>	<p>YEM-H98</p>  <p>352.3 48T 8H</p>
<p>YEM-H99</p>  <p>352.3 46T 8H</p>	<p>YEM-H100</p>  <p>316 50T 8H</p>	<p>YEM-H101</p>  <p>314.2 42T 8H</p>	<p>YEM-H102</p>  <p>352MM 54T</p>
<p>YEM-H103</p>  <p>220 46T 4H</p>	<p>YEM-H104</p>  <p>241.8 50T 8H</p>	<p>YEM-H105</p>  <p>215.8 50T 6H</p>	<p>YEM-H106</p>  <p>168 50T 3H</p>
<p>YEM-H107</p>  <p>168 47T 3H</p>	<p>YEM-H108</p>  <p>180 50T 4H</p>	<p>YEM-H109</p>  <p>300 48T</p>	<p>YEM-H110</p>  <p>135 50T 3H</p>
<p>YEM-H111</p>  <p>155 50T 3H</p>	<p>YEM-H112</p>  <p>178 42T 3H</p>	<p>YEM-H113</p>  <p>180 42T 4H</p>	<p>YEM-H114</p>  <p>210 50T. 6H</p>

<p>YEM-H115</p>  <p>228 46T 8H</p>	<p>YEM-H116</p>  <p>314 47T 8 H</p>	<p>YEM-H117</p>  <p>352 8T 8H</p>	<p>YEM-H118</p>  <p>352 42T 8孔</p>
<p>YEM-H119</p>  <p>352 12T 8H</p>	<p>YEM-H120</p>  <p>柳工945 (230x 8T)</p>	<p>YEM-H121</p>  <p>徐工150(195x6T)</p>	<p>YEM-H122</p>  <p>龙工60 东方红85-9</p>
<p>YEM-H123</p>  <p>卡特305-5 15T</p>	<p>YEM-H124</p>  <p>徐工18 13T</p>	<p>YEM-H125</p>  <p>314 4T 8H</p>	<p>YEM-H126</p>  <p>SK60-7 外径OD:315mm</p>
<p>YEM-H127</p>  <p>SK60-7带内铁 外径OD:315mm</p>	<p>YEM-H128</p>  <p>YC35/CAT304 内齿:8T-13T</p>	<p>YEM-H129</p>  <p>福田65 外径OD:124mm 内齿:8-9T</p>	<p>YEM-H130</p>  <p>福田85 外径OD:175mm 内齿:8-13T</p>

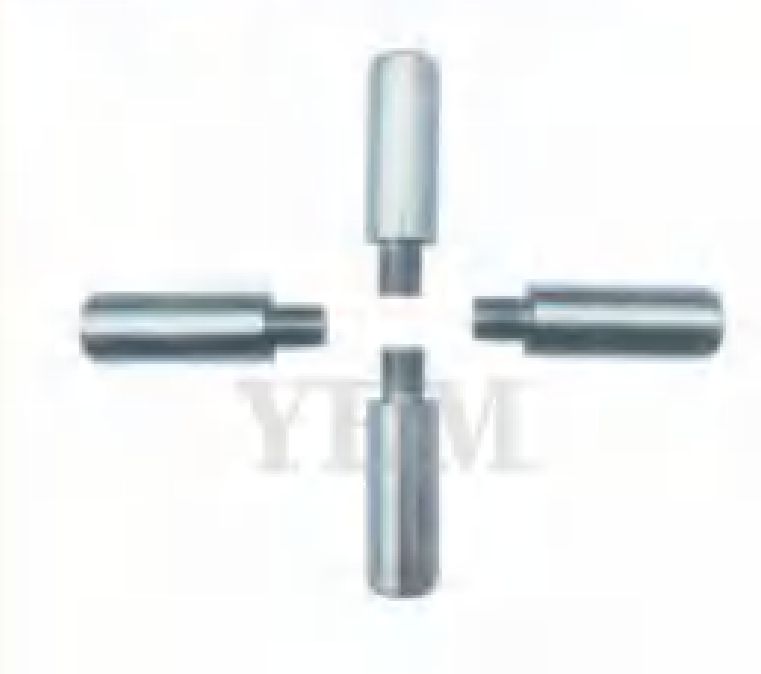

<p>YEM-H160</p>  <p>外齿: 42T 内齿: 13T 内径 ϕ: 22mm</p>	<p>YEM-H161</p>  <p>外齿: 42T 内齿: 13T 内径 ϕ: 19mm</p>	<p>YEM-H162</p>  <p>外齿: 42T 内齿: 14T 内径 ϕ: 28mm</p>	<p>YEM-H163</p>  <p>外齿: 42T 内齿: 14T 内径 ϕ: 35mm</p>
<p>YEM-H164</p>  <p>外齿: 42T 内齿: 15T 内径 ϕ: 21mm</p>	<p>YEM-H165</p>  <p>外齿: 46T 内齿: 12T 内径 ϕ: 28mm</p>	<p>YEM-H166</p>  <p>外齿: 46T 内齿: 12T 内径 ϕ: 40mm</p>	<p>YEM-H167</p>  <p>外齿: 46T 内齿: 14T 内径 ϕ: 28mm</p>
<p>YEM-H168</p>  <p>外齿: 46T 内齿: 14T 内径 ϕ: 35mm</p>	<p>YEM-H169</p>  <p>外齿: 46T 内齿: 14T 内径 ϕ: 40mm</p>	<p>YEM-H170</p>  <p>外齿: 46T 内齿: 12T 内径 ϕ: 32mm</p>	<p>YEM-H171</p>  <p>外齿: 47T 内齿: 14T 内径 ϕ: 32mm</p>
<p>YEM-H172</p>  <p>外齿: 50T 内齿: 12T 内径 ϕ: 22mm 小</p>	<p>YEM-H173</p>  <p>外齿: 50T 内齿: 12T 内径 ϕ: 30mm 中</p>	<p>YEM-H174</p>  <p>外齿: 50T 内齿: 13T 内径 ϕ: 19mm 小</p>	<p>YEM-H175</p>  <p>外齿: 50 内齿: 14T 内径 ϕ: 26mm 小</p>
<p>YEM-H176</p>  <p>外齿: 50T 内齿: 14T 内径 ϕ: 28mm 中</p>	<p>YEM-H177</p>  <p>外齿: 50T 内齿: 14T 内径 ϕ: 30mm 中</p>	<p>YEM-H178</p>  <p>外齿: 50T 内齿: 15T 内径 ϕ: 22mm 小</p>	<p>YEM-H179</p>  <p>外齿: 50T 内齿: 15T 内径 ϕ: 22mm 中</p>

<p>YEM-H180</p>  <p>外齿: 50T 内齿: 15T 内径 ϕ: 28mm 中</p>	<p>YEM-H181</p>  <p>SK60-7内铁</p>	<p>YEM-H182</p>  <p>花键 Gear/spline 85x14T 3孔</p>	<p>YEM-H183</p>  <p>花键 Gear/spline 85x15T 3孔</p>	
<p>YEM-H184</p>  <p>花键 Gear/spline 85x13T 3孔</p>	<p>YEM-H185</p>  <p>花键 Gear/spline 100x60x17T(90H)</p>	<p>YEM-H186</p>  <p>花键 Gear/spline 160X15T(240H)</p>	<p>YEM-H187</p>  <p>花键 Gear/spline 160X17T(240H)</p>	<p>YEM-H188</p>  <p>花键 Gear/spline EX300330. 15T(110H)</p>
<p>YEM-H189</p>  <p>花键 Gear/spline 改泵K3V112 12T 50高 18厘</p>	<p>YEM-H190</p>  <p>花键 Gear/spline 改泵K3V112 14T 50高 18厘</p>	<p>YEM-H191</p>  <p>花键 Gear/spline K3V112 内齿: 12T(薄/Thin)</p>	<p>YEM-H192</p>  <p>花键 Gear/spline K3V112 内齿: 12T(厚/Thin)</p>	<p>YEM-H193</p>  <p>花键 Gear/spline K3V112 内齿: 14T(薄/Thin)</p>
<p>YEM-H194</p>  <p>花键 Gear/spline K3V112 内齿: 14T(厚/Thin)</p>	<p>YEM-H195</p>  <p>花键 Gear/spline K3V63 内齿: 14T(薄/Thin)</p>	<p>YEM-H196</p>  <p>花键 Gear/spline K3V63 内齿: 14T(厚/Thin)</p>	<p>YEM-H197</p>  <p>花键 Gear/spline CAT320 内齿: 15T</p>	<p>YEM-H198</p>  <p>花键 Gear/spline CAT320C 内齿: 17T</p>
<p>YEM-H199</p>  <p>花键 Gear/spline EX200-2/3/5 内齿: 16T</p>	<p>YEM-H200</p>  <p>花键 Gear/spline ZAX200-6 内齿: 15T</p>	<p>YEM-H201</p>  <p>花键 Gear/spline K3V180 内齿: 17T</p>	<p>YEM-H202</p>  <p>花键 Gear/spline K3V180 内齿: 14T</p>	<p>YEM-H203</p>  <p>连接胶螺丝 CAT200B</p>

联轴器系列 COUPLING SERIES

型号 MODEL	外径 OD	内径 ID	高度 HEIGHT
54*15		44/51	71
48*13	176	38/46	65
48*13	176	38/46	74
48*14	176	35/40	66
48*17	176	42/47	63
48*17	176	42/47	58
48*21	176	40.5/45.5	57
48*27	176	45/48	65
50*11	78	16/19	42
50*13	78	19/22	44
50*13	78	20/22.5	43
50*14	78	28/32	44
50*15	78	22/26	44
50*15	78	29/33.2	44
50*12	130	30/35	54
50*14	130	28/32	55
54*14带卡簧 with clamp	130	28/32	68
50*14	130	35/40	54
54*14带卡簧 with clamp	130	35/40	68
50*15	130	29/33	54
50*17	130	42/47	67
50*21	130	42/47.5	53
50*23	130	35/38	54
50*24	130	46/51	53
47*13	98	19/22	55
47*13	98	38/46.5	60
47*14	98	28/32	40
47*15	98	22/26	46

型号 MODEL	外径 OD	内径 ID	高度 HEIGHT
46*15/12	145	44/51	65
46*12	145	30/35	56
46*13	145	38/46	70
46*14	145	27.2/31.2	54
46*14	145	35/40	53
46*17	145	42/47.5	63
46*17/14	145	40/46.5	65
46*21	145	32/35	68
46*21	145	40/45	59
46*23	145	35/38	59
46*24	145	46/51	57
46*24	145	60/65	66
46*27	145	39/43	58
42*12	110	30/35	55
42*13	110	19/22	55
42*13/10	110	38/46	45
42*13	110	38/46.5	55
42*14	110	35/40	55
42*14	110	28/32	55
42*15	110	22/25.3	55
42*15	110	28.5/33	55
42*18	110	36/40	70
42*21	110	32/35	55
42*21	110	40.5/45.5	55
42*23	110	35/38	49
42*23	110	35.2/38.5	70
42*27	110	39.5/43	55

齿数 TEETH	内径 ID	外径 OD	高度 HEIGHT	孔数 HOLES	螺丝 BOLTS
10T	14.5/18	60	36	3	10
	30/35	100	65	4	16
12T	30/35	85	45	4	16
	30/35	100	65	4	18
13T	19*22	70	50	3	12
	19*22	100	50	3	16
	19*22	85	45	3	14
	35*40	100	62	4	16
	35*40	100	62	4	18
14T	27*31	100	57	4	16
	35*40	125	62	4	20
	35*40	100	50	4	16
	28*31.5	100	66	4	16
	34*37.8	100	54	4	16
17T	42*47	100	45	4	18
	42*47	125	42	4	20
	28*31	85	42	4	16
	40*46	100	65	4	16

齿数 TEETH	内径 ID	外径 OD	高度 HEIGHT	孔数 HOLES	螺丝 BOLTS
	22*26	70	37	3	12
	22*26	85	45	3	14
	37*42	85	44	4	16
	35*40	85	53	4	16
	35*40	100	65	4	16
	44*51	100	45	4	16
15T	36*42	100	45	4	16
	44*51	100	47	4	18
	44*51	100	50	4	18
	29*34	100	57	4	16
	29*34	100	66	3	16
	44*51	125	62	4	20
	44*50	125	78	4	20
16T	40*45	85	42	4	16
	40*45	100	62	4	16
21T	40*45	100	66	3	16
22T	44*49	125	53	4	20

肥仔胶 FATS GLUE 平行胶 PARALLEL GLUE 分油点胶盖 OIL CUP RUBBER COVER

 <p>32肥仔胶 32肥仔胶总成</p>	 <p>34肥仔胶 34肥仔胶总成</p>	 <p>38肥仔胶 38肥仔胶总成</p>	 <p>42肥仔胶 42肥仔胶总成</p>	 <p>45肥仔胶 45肥仔胶总成</p>
 <p>48肥仔胶 48肥仔胶总成</p>	 <p>51肥仔胶 51肥仔胶总成</p>	 <p>60肥仔胶 60肥仔胶总成</p>	 <p>71肥仔胶 71肥仔胶总成</p>	 <p>6D95平行胶 250×80Φ</p>
 <p>PC200-3平行胶 Balance rubber</p>	 <p>6D14平行胶 Balance rubber</p>	 <p>6D22平行胶 Balance rubber</p>	 <p>6HK平行胶 Balance rubber</p>	 <p>EX200-6分油忠胶盖 Minute Oil Loyal</p>
 <p>E312分油忠胶盖 Minute Oil Loyal</p>	 <p>E320B/C/D分油忠胶盖 Minute Oil Loyal</p>	 <p>E200B分油忠胶盖 Minute Oil Loyal</p>	 <p>E320分油忠胶盖 MINUTE OIL LOYAL</p>	 <p>EX200-1分油忠胶盖 MINUTE OIL LOYAL</p>
 <p>EX200-5分油忠胶盖 MINUTE OIL LOYAL</p>	 <p>EX200-2/3分油忠胶盖 MINUTE OIL LOYAL</p>	 <p>VOLVO分油忠胶盖 MINUTE OIL LOYAL</p>	 <p>DH分油忠胶盖 MINUTE OIL LOYAL</p>	 <p>柳工分油忠胶盖 MINUTE OIL LOYAL</p>
 <p>R225-7分油忠胶盖 MINUTE OIL LOYAL</p>	 <p>SK250-8分油忠胶盖 MINUTE OIL LOYAL</p>	 <p>SK200-6/8分油忠胶盖 MINUTE OIL LOYAL</p>	 <p>SK200-1/3/5分油忠胶盖 MINUTE OIL LOYAL</p>	 <p>SK60分油忠胶盖 MINUTE OIL LOYAL</p>

机脚胶 ENGINE CUSHION

<p>YEM-H234</p>  <p>PC20/30</p>	<p>YEM-H235</p>  <p>PC40</p>	<p>YEM-H236</p>  <p>PC60-7/4D95</p>	<p>YEM-H237</p>  <p>4D102</p>
<p>YEM-H238</p>  <p>PC200-3</p>	<p>YEM-H239</p>  <p>PC200-5 前</p>	<p>YEM-H240</p>  <p>PC200-5 后</p>	<p>YEM-H241</p>  <p>6D102 前</p>
<p>YEM-H242</p>  <p>6D102 后</p>	<p>YEM-H243</p>  <p>PC-8 前</p>	<p>YEM-H244</p>  <p>PC-8 后</p>	<p>YEM-H245</p>  <p>EX60 后</p>
<p>YEM-H246</p>  <p>ZAX70 下</p>	<p>YEM-H247</p>  <p>EX120</p>	<p>YEM-H248</p>  <p>EX200-2/3/5前</p>	<p>YEM-H249</p>  <p>EX200-1/2/3后</p>
<p>YEM-H250</p>  <p>ZAX70后</p>	<p>YEM-H251</p>  <p>ZAX230 前</p>	<p>YEM-H252</p>  <p>EX200-5 后</p>	<p>YEM-H253</p>  <p>EX200-6后</p>

机脚胶 ENGINE CUSHION

<p>YEM-H254</p>  <p>ZAX55/60</p>	<p>YEM-H255</p>  <p>ZAX70前</p>	<p>YEM-H256</p>  <p>ZAX230后</p>	<p>YEM-H257</p>  <p>ZAX240-3电喷</p>
<p>YEM-H258</p>  <p>ZAX330前</p>	<p>YEM-H259</p>  <p>ZAX330-3</p>	<p>YEM-H260</p>  <p>EX300前</p>	<p>YEM-H261</p>  <p>EX300后</p>
<p>YEM-H262</p>  <p>E307 前</p>	<p>YEM-H263</p>  <p>E307 后</p>	<p>YEM-H264</p>  <p>E308后</p>	<p>YEM-H265</p>  <p>E312 前</p>
<p>YEM-H266</p>  <p>E312 后</p>	<p>YEM-H267</p>  <p>E200B</p>	<p>YEM-H268</p>  <p>E320B</p>	<p>YEM-H269</p>  <p>E330</p>
<p>YEM-H270</p>  <p>DH300-7前</p>	<p>YEM-H271</p>  <p>DH300-7后</p>	<p>YEM-H272</p>  <p>DH350-7前</p>	<p>YEM-H273</p>  <p>R60</p>

机脚胶 ENGINE CUSHION

机脚胶 ENGINE CUSHION

<p>YEM-H274</p>  <p>R60</p>	<p>YEM-H275</p>  <p>DH350-7后</p>	<p>YEM-H276</p>  <p>现代220</p>	<p>YEM-H277</p>  <p>现代220</p>
<p>YEM-H278</p>  <p>YC35</p>	<p>YEM-H279</p>  <p>HD450 前</p>	<p>YEM-H280</p>  <p>HD450 后</p>	<p>YEM-H281</p>  <p>YC65</p>
<p>YEM-H282</p>  <p>YC85-8前</p>	<p>YEM-H283</p>  <p>YC85-8后</p>	<p>YEM-H284</p>  <p>SH60三角形</p>	<p>YEM-H285</p>  <p>山河智能50</p>
<p>YEM-H286</p>  <p>山河智能70</p>	<p>YEM-H287</p>  <p>HD250后</p>	<p>YEM-H288</p>  <p>力士德前</p>	<p>YEM-H289</p>  <p>力士德后</p>
<p>YEM-H290</p>  <p>久保田</p>	<p>YEM-H291</p>  <p>国产13厘</p>	<p>YEM-H292</p>  <p>国产17厘</p>	<p>YEM-H293</p>  <p>山河智能</p>

<p>YEM-H294</p>  <p>LS120</p>	<p>YEM-H295</p>  <p>订做</p>	<p>YEM-H296</p>  <p>DH55前</p>	<p>YEM-H297</p>  <p>DH55后</p>
<p>YEM-H298</p>  <p>水箱胶 方形</p>	<p>YEM-H299</p>  <p>水箱胶 圆形</p>	<p>YEM-H300</p>  <p>SK60前</p>	<p>YEM-H301</p>  <p>SK120前</p>
<p>YEM-H302</p>  <p>SK120 后</p>	<p>YEM-H303</p>  <p>6D31 前</p>	<p>YEM-H304</p>  <p>6D31 后</p>	<p>YEM-H305</p>  <p>6D34</p>
<p>YEM-H306</p>  <p>SK200-8 J05</p>	<p>YEM-H307</p>  <p>SK200-8 J05</p>	<p>YEM-H308</p>  <p>SK350-8 J08</p>	<p>YEM-H309</p>  <p>4D31后</p>
<p>YEM-H310</p>  <p>6D22</p>	<p>YEM-H311</p>  <p>SH210-5</p>	<p>YEM-H312</p>  <p>SH200</p>	<p>YEM-H313</p>  <p>SH200A1</p>

机脚胶 ENGINE CUSHION

机脚胶 ENGINE CUSHION

<p>YEM-H314</p>  <p>SH200A3</p>	<p>YEM-H315</p>  <p>DH55前</p>	<p>YEM-H316</p>  <p>DH55后</p>	<p>YEM-H317</p>  <p>DH60-7</p>
<p>YEM-H318</p>  <p>DH130前</p>	<p>YEM-H319</p>  <p>DH130-5后</p>	<p>YEM-H320</p>  <p>DH180-7</p>	<p>YEM-H321</p>  <p>DH80-9</p>
<p>YEM-H322</p>  <p>DH220-3前</p>	<p>YEM-H323</p>  <p>DH220-3后</p>	<p>YEM-H324</p>  <p>DH220-5</p>	<p>YEM-H325</p>  <p>DH225-7</p>
<p>YEM-H326</p>  <p>DH250前</p>	<p>YEM-H327</p>  <p>DH280前</p>	<p>YEM-H328</p>  <p>DH280后</p>	<p>YEM-H329</p>  <p>DH330-3</p>

<p>YEM-H330</p>  <p>A 驾驶室减震胶 PC200-7 B 驾驶室减震胶 ZX200</p>	<p>YEM-H331</p>  <p>A 驾驶室减震胶 SH200A3 130X163X16 φ B 驾驶室减震胶 SH200 137X160X16 φ</p>	<p>YEM-H332</p>  <p>驾驶室减震胶 EX200 160X120X16 φ</p>	<p>YEM-H333</p>  <p>驾驶室减震胶 EX200 126X100X11 φ</p>
<p>YEM-H334</p>  <p>驾驶室胶 VOLVO</p>	<p>YEM-H335</p>  <p>减震胶 148x94x10 φ</p>	<p>YEM-H336</p>  <p>减震胶 128x77x10 φ</p>	<p>YEM-H337</p>  <p>减震胶</p>
<p>YEM-H338</p>  <p>CASEL-BUMPER</p>	<p>YEM-H339</p>  <p>D136527 CASEK-BUMPER</p>	<p>YEM-H340</p>  <p>RWD NO 8N1214</p>	<p>YEM-H341</p>  <p>减震胶 80X180X130 φ</p>
<p>YEM-H342</p>  <p>减震胶 235x160x119 φ</p>	<p>YEM-H343</p>  <p>减震胶 243x243x140 φ</p>	<p>YEM-H344</p>  <p>减震胶</p>	<p>YEM-H345</p>  <p>减震胶NPK 286X235X85 φ</p>
<p>YEM-H346</p>  <p>减震胶 170X170X105 φ</p>	<p>YEM-H347</p>  <p>减震胶 177X177X115 φ</p>	<p>YEM-H348</p>  <p>减震胶NPK 285X285X85 φ</p>	<p>YEM-H349</p>  <p>减震胶NPK 330X295X85 φ</p>

YEM-H350



PC200-5

YEM-H351



PC200-6

YEM-H352



PC200-7

YEM-H362



EX200-6

YEM-H363



ZAXIS 70

YEM-H364



ZAXIS210-3

YEM-H365



ZAX-5G

YEM-H353



PC200-8

YEM-H354



E200B

YEM-H355



E320B

YEM-H366



SK200-6

YEM-H367



SK200-8

YEM-H368



SK60

YEM-H369



DH

YEM-H356



E320C

YEM-H357



E320C

YEM-H358



E320D

YEM-H370



DH220-5

YEM-H371



DH225-7

YEM-H372



SH200A3

YEM-H359



E320D 329D

YEM-H360



EX200-2/3

YEM-H361



EX200-5

YEM-H373



SH200

YEM-H374



SH200

YEM-H375



SH200



YEM-H376



YEM-H377

型号	长x宽x高	螺丝孔距
230螺丝	230X65X35	150
300螺丝	300X68X40	200
380扣式	380X104X41	
400螺丝	400X104X41	300
400扣式	左右洋马专用	
450螺丝	450X115X47	350x56
450扣式	450X110X40	350x45
450扣式	450X150X55	350
500螺丝	500X115X60	400
500扣式	500X127X66	400
550扣式	550X115X63	
600扣式	600X138X71	500



YEM-H378
皮带 BELT



YEM-H379
GB-皮带 belt

系列	机型	风扇.发动机皮带	空调皮带	
现代	200	8PK1420		
	290L-3	8PK1535		
	210-3	PK1425		
	210-5	9430	6430	
	220	8PK1150		
	220-5	8PK1430	6460	
	120-5	6PK1200		
	335	9PK1830		
	260	8PK1650		
	130	8PK1430	6470	
	225-7	8PK1440	6470	
	200-3	8PK1435		
	215-7	9430		
	系列	机型	风扇.发动机皮带	空调皮带
	加藤	HD512	6480	6590
HD700-7		6460	6590	
HD820(6D34)		8450	6590	
HD700-2/5		8450	8410	
HD450		8450		
HD770		8400		
HD800-5/6D14		8420		
HD1250-5/6D22		9550-9560		
HD1250-5/6D22		9635		
HD770-2		8410		
HD1430		9560		
HD900-7		9550		
系列	机型	风扇.发动机皮带	空调皮带	
大字	220-5			
	220-3			
	280-3			
	220-2			
	300			
	325			
	300			
	55			
	330-3			
	系列	机型	风扇.发动机皮带	空调皮带
沃尔沃	210	8PK1480		
沃尔沃	沃尔沃	10PK1400	8PK1600	
系列	机型	风扇.发动机皮带	空调皮带	
住友	SH200(6BG1)	8475	8445	
	SH280F2	8465		
	SH200-6BG	8490		
	LS280-6GB	8480		
	SH280F2	8570	6430	
	SH120	8450	6450	
	SH250	8455		
	350(6D24)	9560	8410	
	60		6370	
	200-3	8480	8455	
	300	Mar-55		
	系列	机型	风扇.发动机皮带	空调皮带
神刚	SK230	8470	8445	
	SK200-5	8450	6570	
	SK200-3	6460	8440	
	SK0TN2	8450		
	SK200-6	6460	8450	
	SK200-7	6460	6420	
	SK200-6/6D31	8480		
	SK330/6D16	8440		
	SK120-5	8455		
	SK450	1510(发)1150		
	SK300	9470		
	SK210-6	8450		
	SK60			
	SK350	9590		
	SK320	9530		
	SK230/6D34	8460		
	SK450	9700	9630	
	SK60-1	6380	6530	
	沃尔沃	10PK1480		

系列	机型	风扇皮带	空调皮带	水泵皮带
日立	EX200-1	8480	8440	
	EX200-2	8480	6480	
	EX200-3	8480	6430	
	EX300-3	8480	8400	
	EX200-5	8560	8400	
	EX400	8680		
	EX220-2	8570		
	EXCAT-320	8480		
	EX300-2	8470	8440	
	EX210	8560	8400	
	EX55	6360	6430	
	EX200-7			
	B6A102	8PK1420		
	EX200-6	8470		
	EX100-3	6490	8660	6560
	6DB1	8480		
	4D95	8460		
	6D31	6470		
	NT855	9400	6PK1105	
	EX120-3(4BG1)	8480		
EX330	8480	8480	8480	
EX220-5	8480	8400		
EX400-1	8650			
EX330	8570			
EX470	9580	8570		
EX240-3	8PK1155			
6D31	6470			
系列	机型	风扇.发动机皮带	空调皮带	水泵皮带
卡特	E312	8460		
	E325	8560		
	E200B	8470	8410	6400
	E320B	8470	8410	
	E300B	9570	6390	
	E330	9590	6400	
	E320C	8480	6470	
	E330C	8PK2245		
	E320	8450	6440	
	E350	10PK1480		
	E320C	12PK1880	6470	
	E330B	9560	6390	
	E325C	8PK2175	原厂号1834494	
	E320	8PK1460		
	E325BX		6330	6560
	E312B	8460		
	E313BSR	6440	6550	
	E322	9580	1510	1330
	ED13	8PK2020		
	ED6	9670		
E325BX	8580		6330	
系列	机型	风扇.发动机皮带	空调皮带	水泵皮带
小松	PC40	8460	8410	
	PC60-5/6	8470	6440	
	PC100-3	8470		
	PC100-6	8PK1460	8430	
	PC120-6	8PK1500	8420	
	4D95	8PK1535	6440	
	PC200-3	8480	8420	
	PC200-6/6D102	8PK1689/8440	8390	
	6D95	9PK1905	8430	
	PC200.220-1	8570		
	PC200.220-5	8490	8410	
	PC220.240-3	8480	8420	
	PC300-5	9PK1180	8420	4PK1350
	PC300-6	9PK1180	8420	8PK1340
	PC300-3	9570		
	PC400-5/6	9610.962	8540	
	PC400-3	9630	8440	8540
	PC360-5	9580		
	PCD50P	9680		
	4D130	8600		
	D60-11	9730		
	NA220	9700		
	PC760	9650		
	PC/S6D125-1	9620		
	PC300-7	8PK1600/1610	8PK1217	
	PC200-7	8PK1480	8470	
	PC360-7	8PK1230	8600	
	PC220-7	8PK1525	8475	
	D70	9670		
	PC210	8PK1840/1850		
PC310	9PK1330			
PC220-6	10PK1425	6PK1689		
PC350	8PK1600/1610			

水管系列 HOSE SERIES

水管系列 HOSE SERIES

<p>YEM-H380</p> <p>上水管/下水管 PC60-7(4D102)</p>	<p>YEM-H381</p> <p>上水管/下水管 PC60-7(4D95)</p>	<p>YEM-H382</p> <p>上水管/下水管 PC60-3/5</p>	<p>YEM-H383</p> <p>上水管 PC60-6</p>
<p>YEM-H384</p> <p>上水管/下水管 PC100-6(4D102) PC120-6(4D102)</p>	<p>YEM-H385</p> <p>上水管/下水管 PC100-6 PC120-6(4D95)</p>	<p>YEM-H386</p> <p>下水管/下水管 PC100-5 PC120-5 (NEW) / (OLD)</p>	<p>YEM-H387</p> <p>上水管/下水管 PC100-3 PC120-3</p>
<p>YEM-H388</p> <p>上水管 PC100-5 PC120-5 (OLD)/(NEW)</p>	<p>YEM-H389</p> <p>上水管/下水管 PC130-7</p>	<p>YEM-H390</p> <p>上水管/下水管 PC200-3</p>	<p>YEM-H391</p> <p>上水管/下水管 PC200-5</p>
<p>YEM-H392</p> <p>上水管/下水管 PC200-6(6D95) PC210-6(6D95) PC220-6(6D95)</p>	<p>YEM-H393</p> <p>上水管/下水管 PC200-6(6D102) PC210-6(6D102) PC220-6(6D102)</p>	<p>YEM-H394</p> <p>上水管/下水管 PC200-7/210-7 PC220-7</p>	<p>YEM-H395</p> <p>上水管/下水管 PC200-8/210-8 220-8/240-8</p>

<p>YEM-H396</p> <p>上水管 PC300-5</p>	<p>YEM-H397</p> <p>下水管 PC300-5 PC300-6 PC350-6</p>	<p>YEM-H398</p> <p>上水管 PC300-6 PC350-6</p>	<p>YEM-H399</p> <p>上水管/下水管 PC300-7 PC350-7 PC360-7(直喷)</p>
<p>YEM-H400</p> <p>上水管/下水管 PC400-1/2/3/5</p>	<p>YEM-H401</p> <p>上水管/下水管 PC400-6 PC450-6</p>	<p>YEM-H402</p> <p>上水管/下水管 PC400-7/PC450-7(直喷)</p>	<p>YEM-H403</p> <p>上水管/下水管 ZAXIS60/ZAXIS70</p>
<p>YEM-H404</p> <p>上水管/下水管 ZAXIS100/110 ZAXIS120</p>	<p>YEM-H405</p> <p>上水管/下水管 ZAXIS200/210 230/240/270</p>	<p>YEM-H406</p> <p>上水管/下水管 ZAXIS330/350/360</p>	<p>YEM-H407</p> <p>上水管 ZAXIS200-3/210-3</p>
<p>YEM-H408</p> <p>上水管 ZAXIS240-3/250-3</p>	<p>YEM-H409</p> <p>下水管 ZAXIS200-3 ZAXIS210-3 ZAXIS240-3 ZAXIS250-3</p>	<p>YEM-H410</p> <p>上水管/下水管 ZAXIS450/460 ZAXIS480</p>	<p>YEM-H411</p> <p>上水管/下水管 EX100-2/3/ EX120-2/3</p>

水管系列 HOSE SERIES

水管系列 HOSE SERIES

<p>YEM-H412</p>  <p>上水管/下水管 EX100-5 EX120-5</p>	<p>YEM-H413</p>  <p>上水管/下水管 EX200-1</p>	<p>YEM-H414</p>  <p>上水管/下水管 EX200-2/3</p>	<p>YEM-H415</p>  <p>上水管/下水管 EX200-5</p>
<p>YEM-H416</p>  <p>上水管/下水管 EX300-5/EX350-5 EX300/EX350</p>	<p>YEM-H417</p>  <p>上水管/下水管 EX220-5 EX230-3 EX220-2/3</p>	<p>YEM-H418</p>  <p>上水管/下水管 EX300-2/3</p>	<p>YEM-H419</p>  <p>上水管/下水管 DH55</p>
<p>YEM-H420</p>  <p>上水管/下水管/下水管 DH60/DH60-7</p>	<p>YEM-H421</p>  <p>直水管/上水管 下水管 DH130/DH150</p>	<p>YEM-H422</p>  <p>直水管/上水管 下水管 DH220-5</p>	<p>YEM-H423</p>  <p>上水管/下水管 DH225</p>
<p>YEM-H424</p>  <p>上水管/下水管 DH360-5</p>	<p>YEM-H425</p>  <p>上水管/下水管 DH280</p>	<p>YEM-H426</p>  <p>上水管/下水管 DH300/DH300-5 DH300-7</p>	<p>YEM-H427</p>  <p>上水管/下水管 CAT330D/D360D C9</p>

<p>YEM-H428</p>  <p>上水管/下水管 E120B/E312</p>	<p>YEM-H429</p>  <p>上水管/中水管/下水管 E200B</p>	<p>YEM-H430</p>  <p>上水管/下水管 CAT307/307B</p>	<p>YEM-H431</p>  <p>上水管/下水管 CAT325C</p>
<p>YEM-H432</p>  <p>上水管/中水管 下水管 CAT320</p>	<p>YEM-H433</p>  <p>上水管/中水管 下水管 CAT320B</p>	<p>YEM-H434</p>  <p>上水管/下水管 CAT320C</p>	<p>YEM-H435</p>  <p>上水管/下水管 CAT320C (中冷) (With a cold engine)</p>
<p>YEM-H436</p>  <p>上水管/上水管 下水管 CAT320B</p>	<p>YEM-H437</p>  <p>上水管/下水管 CAT325D</p>	<p>YEM-H438</p>  <p>上水管/下水管 CAT330/CAT330B</p>	<p>YEM-H439</p>  <p>上水管/下水管 CAT330C</p>
<p>YEM-H440</p>  <p>上水管/下水管 SK100-1/SK120-1</p>	<p>YEM-H441</p>  <p>上水管/下水管 SK100-2/3/5/6/ SK120-2/3/5/6</p>	<p>YEM-H442</p>  <p>上水管/下水管 SK200-8/E 210-8/E</p>	<p>YEM-H443</p>  <p>上水管/下水管 SK200-1/3</p>

水管系列 HOSE SERIES

水管系列 HOSE SERIES

<p>YEM-H444</p> <p>上水管/下水管 SK200-2/5</p>	<p>YEM-H445</p> <p>上水管/下水管 SK200-6</p>	<p>YEM-H446</p> <p>上水管/下水管 SK230-6/E SK250-6/E</p>	<p>YEM-H447</p> <p>上水管/下水管 SK250-8/E SK260-8/E</p>
<p>YEM-H448</p> <p>上水管/下水管 SK330-8/E SK350-8/E</p>	<p>YEM-H449</p> <p>上水管/下水管 SK300-1/2/3 SK310-2/3 SK320-1/2/3</p>	<p>YEM-H450</p> <p>上水管/下水管 下水管 SK320-6/E SK330-6/E SK350-6/E</p>	<p>YEM-H451</p> <p>上水管/下水管/下水管 SK400-6/E/450-6/E</p>
<p>YEM-H452</p> <p>上水管/下水管 R130-3/-5</p>	<p>YEM-H453</p> <p>上水管/下水管 R200/R200-5 R210-5</p>	<p>YEM-H454</p> <p>上水管/下水管 R210-3/R220-5</p>	<p>YEM-H455</p> <p>上水管/下水管 R215-7</p>
<p>YEM-H456</p> <p>上水管/下水管 R210-7/R225-7</p>	<p>YEM-H457</p> <p>上水管/下水管 R290-3/R300-5</p>	<p>YEM-H458</p> <p>上水管/中水管 下水管 HD250-5/7</p>	<p>YEM-H459</p> <p>上水管/下水管 HD400/-5/-7 HD450-5/7 HD512</p>

<p>YEM-H460</p> <p>上水管/下水管 HD700-5/7</p>	<p>YEM-H461</p> <p>上水管/中水管/下水管 HD700-2 HD800-5/7 HD900-5/7</p>	<p>YEM-H462</p> <p>上水管/下水管 HD820/1/2/3</p>	<p>YEM-H463</p> <p>上水管/下水管 HD1250-7 HD1430</p>
<p>YEM-H464</p> <p>上水管/下水管 SH120/120A1 120A2</p>	<p>YEM-H465</p> <p>上水管/下水管 SH200A3</p>	<p>YEM-H466</p> <p>上水管/下水管 SH280LS2800</p>	<p>YEM-H467</p> <p>上水管/下水管 SH340</p>
<p>YEM-H468</p> <p>上水管/下水管 SH260/SH265 HD400-5</p>	<p>YEM-H469</p> <p>上水管/下水管 SH200/SH200A1 SH200A2 EX200-5</p>	<p>YEM-H470</p> <p>上水管/下水管 EC55BLC EC60BLC</p>	<p>YEM-H471</p> <p>上水管/中水管 下水管 EC210BLC EC210BP EC210BLC</p>
<p>YEM-H472</p> <p>上水管/中水管 下水管 EC210BP (共轨发动机)</p>	<p>YEM-H473</p> <p>上水管/下水管 EC240BLC EC290BLC</p>	<p>YEM-H474</p> <p>上水管/直水管 下水管 EC360BLC(D12C) EC460BLC</p>	<p>YEM-H475</p> <p>上水管/下2/下1 EC360BLC(12152) EC460BLC</p>

进气管 AIR FEEDER TUBE





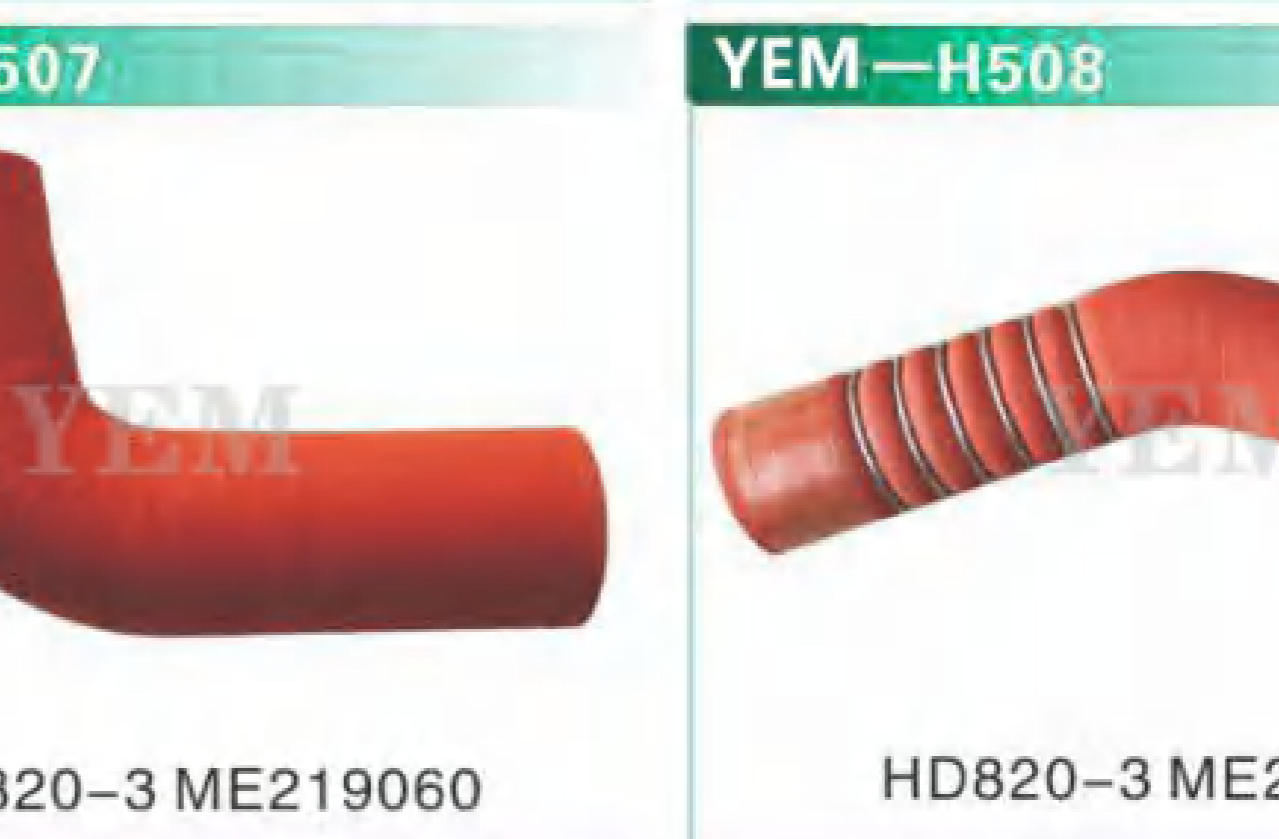
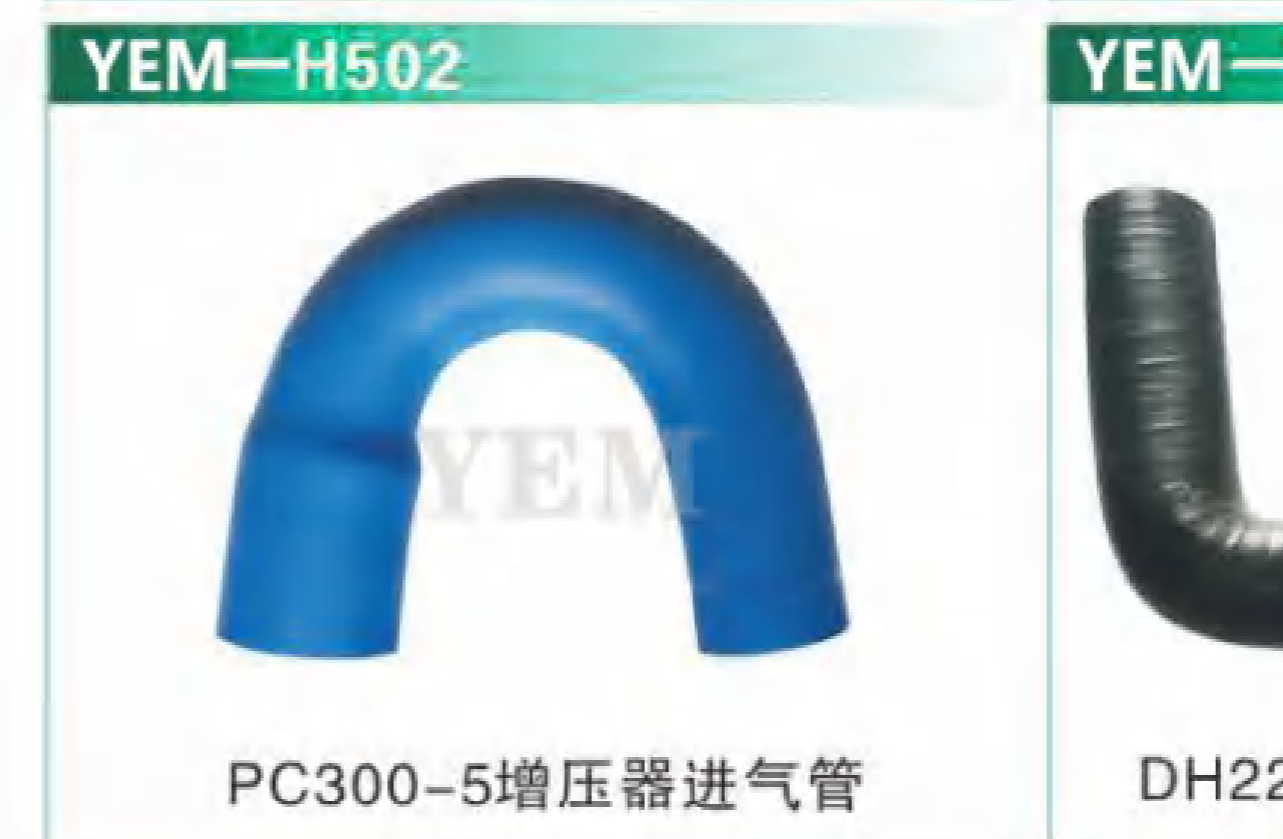















进气管 AIR FEEDER TUBE



进气管 AIR FEEDER TUBE

<p>YEM-H516</p>  <p>CAT315中冷管305-4961</p>	<p>YEM-H517</p>  <p>CAT315中冷管305-7662</p>	<p>YEM-H518</p>  <p>CAT320B空滤进气管</p>	
<p>YEM-H519</p>  <p>CAT320B空气滤芯进气管118-9892</p>	<p>YEM-H520</p>  <p>CAT320C</p>	<p>YEM-H521</p>  <p>CAT330D空滤管 266-6217</p>	
<p>YEM-H522</p>  <p>E200B进气管</p>	<p>YEM-H523</p>  <p>E312进气管</p>	<p>YEM-H524</p>  <p>E320B空气管E8200 1500 1700</p>	
<p>YEM-H525</p>  <p>E320B涡轮增压器进气管116-3118</p>	<p>YEM-H526</p>  <p>E320C S形进气管</p>	<p>YEM-H527</p>  <p>E320CE324DE329D 230-2865</p>	
<p>YEM-H528</p>  <p>CAT345B增压器进气管</p>	<p>YEM-H529</p>  <p>E120B200B 085-8396</p>	<p>YEM-H530</p>  <p>E320B增压器管 7Y-1910</p>	<p>YEM-H531</p>  <p>E320D/E325D空滤进气管 230-2866 73X73X13CM</p>
<p>YEM-H532</p>  <p>E320D/E325 搭桥管头大头小电喷265-3591</p>	<p>YEM-H533</p>  <p>E325D进气管190-5791</p>	<p>YEM-H534</p>  <p>E320C中冷直喷 210-8011</p>	<p>YEM-H535</p>  <p>E345D增压器进气管</p>

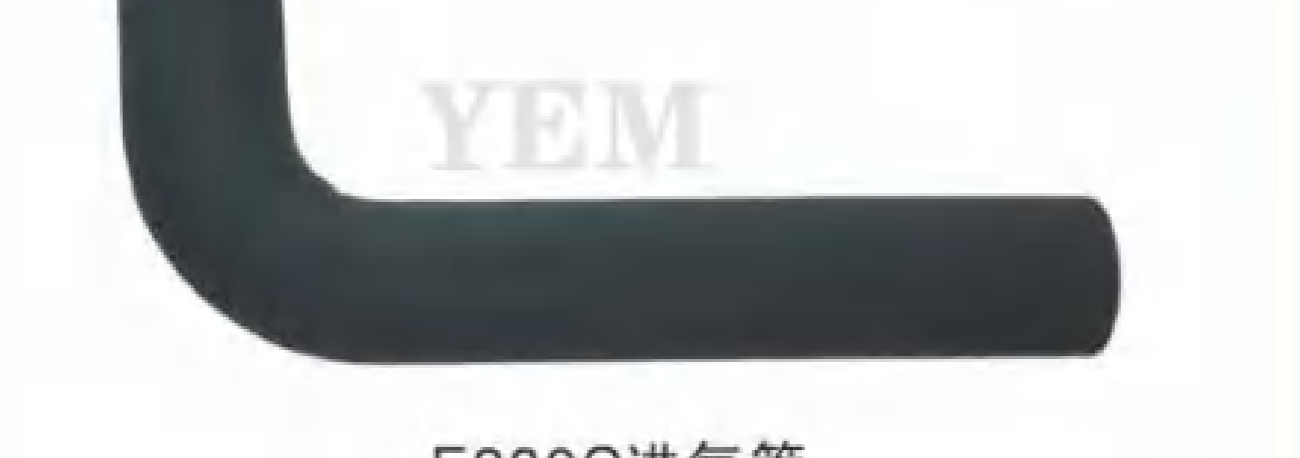
进气管 AIR FEEDER TUBE

<p>YEM-H536</p>  <p>E320C不带中冷6228</p>	<p>YEM-H537</p>  <p>E320C带中冷E320D直喷 205-6687</p>	<p>YEM-H538</p>  <p>E320C带中冷E320D直喷 210-8107</p>
<p>YEM-H539</p>  <p>E320C带中冷E320D直喷204-0946</p>	<p>YEM-H540</p>  <p>E320C带中冷E320D直喷204-0947</p>	<p>YEM-H541</p>  <p>E320C进气管205-6686</p>
<p>YEM-H542</p>  <p>E320C中冷管E320D直喷 210-8108</p>	<p>YEM-H543</p>  <p>E320DE325D空滤进气管 255-2866</p>	<p>YEM-H544</p>  <p>E320D电喷E323D 265-3585</p>
<p>YEM-H545</p>  <p>E320D电喷E323D中冷器出气软管265-3586</p>	<p>YEM-H546</p>  <p>E320D空滤进气管</p>	<p>YEM-H547</p>  <p>E320直喷E323D中冷器出气软管265-3599</p>
<p>YEM-H548</p>  <p>E325C搭桥管 190-5794</p>	<p>YEM-H549</p>  <p>E325C搭桥管</p>	<p>YEM-H550</p>  <p>E330C搭桥管204-1045</p>
<p>YEM-H551</p>  <p>E329D中冷箱发电机2管 230-2868</p>	<p>YEM-H552</p>  <p>E330C进气管</p>	<p>YEM-H553</p>  <p>E330DE336D 230-2933</p>

进气管 AIR FEEDER TUBE

进气管 AIR FEEDER TUBE

YEM-H554



E330DE336D 230-2934

YEM-H555



E330DE336D 230-2940

YEM-H556



E330DE336D 230-2941

YEM-H572



ZAX330中冷器软管 3090879H

YEM-H573



ZAX200210240270直喷 4420341H

YEM-H574



ZAXIS60空气管 3109825H

YEM-H557



E330DE336D空滤进气管266-6217

YEM-H558



E330DE336D增压器进气管 266-6216

YEM-H559



E330EE330B增压器进气管 1099459

YEM-H575



ZAXIS70 3091185H

YEM-H576



ZAXIS200-3 4643558H

YEM-H577



ZAXIS200-3 4643559H

YEM-H560



E324325D329D中冷箱到发动机1管 230-2867

YEM-H561



SK200-8进气管

YEM-H562



R220 进气管

YEM-H578



ZAXIS200-3 4643560H

YEM-H579



ZAXIS200-3 4643561H

YEM-H580



ZAX120130
中冷器软管 4423995H

YEM-H563



PC128UU

YEM-H564



SK320-6

YEM-H565



SK250-8

YEM-H581



ZAXIS330 (6HK1) 电喷

YEM-H582



ZAXIS6070 4448641H

YEM-H583



ZAXIS330240 4643570H

YEM-H566



EC210

YEM-H567



EC210 进气管

YEM-H568



EC240/290进气管 长

YEM-H584



ZAX200210240270
直喷中冷器软管4412520H

YEM-H585



ZAXIS330240 4643569H

YEM-H587



ZAXIS330240 463572H

YEM-H569



EX450进气管

YEM-H570



EX450进气管

YEM-H571



ZAX70 3096771H

YEM-H588



PC200-3进气管

YEM-H589



ZAX330中冷器软管
4411937H

YEM-H590



ZAX120/130
ZAX200/210/240/270
直喷 4411793H

YEM-H591



6BD1 铝管

O型圈O-RING

O型圈O-RING

YEM-H592



PC60 PC100 PC200
升级版

YEM-H593



E320/312
升级版

YEM-H594



EX200
升级版

YEM-H595



HD700 HD820 HD1023
升级版

YEM-H596



DH220-5
升级版

YEM-H597



R60 R200
升级版

YEM-H598



SK200-6
升级版

YEM-H599



SH200A1/2
升级版

YEM-H600



ABC盒装O型圈

YEM-H601



盒装O型圈

YEM-H602



盒装O型圈

YEM-H603



盒装O型圈

YEM-H604



盒装O型圈

YEM-H605



盒装O型圈

YEM-H606



盒装O型圈

YEM-H607



大字盒装O型圈

YEM-H608



小松盒装O型圈

YEM-H609



现代盒装O型圈

YEM-H610



GDK盒装O型圈

YEM-H611



神钢盒装O型圈

YEM-H612



小松盒装O型圈

YEM-H613



日立盒装O型圈

YEM-H614



卡特盒装O型圈

YEM-H615



大字盒装O型圈

YEM-H616



沃尔沃盒装O型圈

YEM-H617



神钢盒装O型圈

YEM-H618



住友盒装O型圈

YEM-H619



GATNT盒装O型圈

YEM-H620



GATNT PC盒装O型圈

YEM-H621



GATNT CAT盒装O型圈

YEM-H622



GATNT SH盒装O型圈

YEM-H623



GATNT EC盒装O型圈

YEM-H624



EX盒装O型圈

YEM-H625

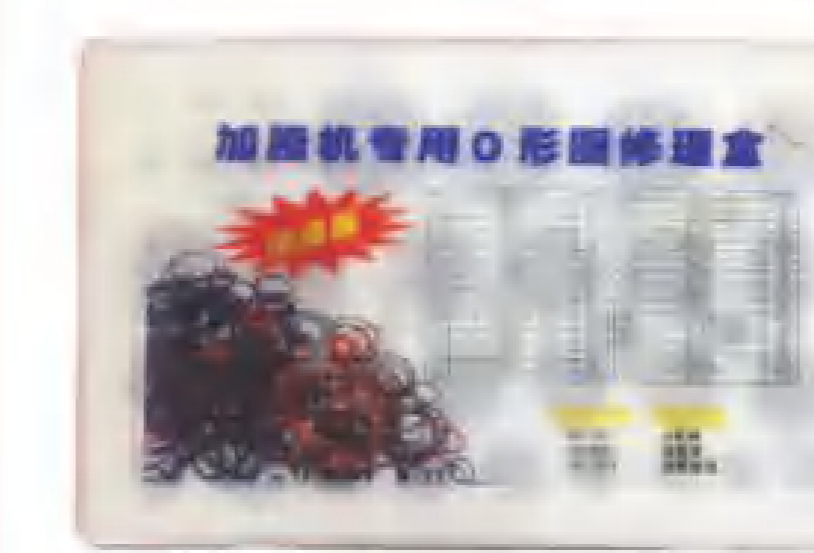

HD盒装O型圈

YEM-H626



R盒装O型圈

YEM-H627



DH盒装O型圈

YEM-H628



VOLVO盒装O型圈

YEM-H629



SH盒装O型圈

YEM-H630



PC盒装O型圈

贴纸 STICKER



YEM-H631
进口广瑞贴纸
Sticker

机型	机型	机型	机型
DH55	EX300-3	PC60-6	SK200-6
DH60-7	EX60-1	PC60-7	SK200-6E
DH200-7	EX60-2	R130-5	SK200-7
DH220-5	EX60-3	R150-7	SK200-8
DH220-7	HD1023	R200-5	SK210-6E
DH225-7	HD450-7	R215-7	SK210-8
DK258-7	DH700-5	R220-5	SK230-6
DH300-5	HD820	R225-7	SK230-6E
DH300-7	HD820-1	R260-5	SK250-6E
E120B	HD820-2	R300-5	SK250-8
E200B	HD820-3	R330LC	SK260-8
E307	PC120-6	R335-7	SK330-6E
E312	PC120-5	R450-5	SK350-8
E320	PC130-7	R60-7	SK60-5
E320B	PC200-7	SH120	ZAX450
E320C	PC200-5	SH120A1(A2)	ZAX55
E320D	PC200-6	SH120A3	ZAX70
E320L	PC200-7	SH160	ZAX120
E325L	PC200-8	SH200A1	ZAX200
E330B	PC210-7	SH200A2	ZAX210
E70B	PC220-5	SH200A3	ZAX230
E85	PC220-6	SH2002	ZAX240
EX100-1	PC220-7	SH220A1	ZAX270
EX120-3	PC228-2	SH220A2	ZAX330
EX120-5	PC300-6	SH220A3	ZAX360
EX120-6	PC300-7	SH60	ZAX80
EX200-1	PC360-7	SH60-2	沃尔沃210
EX200-2	PC400-6	SK120-6	沃尔沃210B
EX200-3	PC55	SK200-3	沃尔沃290
EX200-5	PC60-3	SK200-5	
EX230-5	PC60-5	SK200-5(飞机头)	

斗轴油封、防尘圈、么盘胶条、阻水圈、垫片
SEAL DUST/DUST WIPER/VARIOUS OIL SEALS
WATER SEALS FOR VARIOUS LINERS GASKET

斗轴油封



YEM-H632
聚氨酯斗轴油封 Seal dust

规格	规格	规格	规格
45×60×4	65×80×4	80×95×8	110×125×8
50×65×4	65×80×8	80×90×4	120×140×8
50×65×8	70×85×4	90×105×4	130×150×8
55×65×4	70×85×8	90×105×8	140×160×8
55×65×8	75×90×4	100×115×4	
60×75×4	75×90×8	100×115×8	
60×75×8	80×95×4	110×125×4	



YEM-H633
聚氨酯-防尘圈
Polyurethane dust wiper

YEM-H634
橡胶防尘圈
橡胶防尘圈

防尘圈

规格	规格	规格	规格
φ 60 O形	φ 142 O形	φ 180 O形	φ 175 开口
φ 70 O形	φ 152 O形	φ 142 开口	φ 180 开口
φ 80 O形	φ 157 O形	φ 152 开口	φ 200 开口
φ 90 O形	φ 169 O形	φ 157 开口	φ 220 开口
φ 100 O形	φ 175 O形	φ 169 开口	



YEM-H635
么盘胶条
Various oil seals

么盘胶条机型

规格	规格	规格	规格
6D102	EX200-1	PC200-5外	SH200
E320	EX200-2	PC200-6内	SK200-3
E320C内	EX200-5	PC200-6外	SK200-6
E312C外	DH220-5	PC200-7	ZAX200
EX120	HD700	PC200-3	
PC120-5	PC200-5内	S6K	



YEM-H636
各种缸套阻水圈
Water seals for various liners

阻水圈

规格	规格	规格	规格
4D130	6D125	6D155	NH220
6D105	6D14	E3306	NT855



YEM-H637
斗轴铁垫片 Gasket

斗轴垫片

规格	规格	规格	规格
100×2	90×2	70×3	55×3
100×3	90×3	70×5	55×5
100×5	90×5	65×3	50×3
110×2	80×2	65×5	50×5
110×3	80×3	60×2	
45×3	80×5	60×3	
45×5	70×2	60×5	

排气管 EXHAUSTPIPE

排气管 EXHAUSTPIPE

YEM-H638



4D95

YEM-H639



4D95排气管 不带增压

YEM-H640



4D102排气管

YEM-H653



4BD1

YEM-H654



6BD1
OEM:11414-4480

YEM-H655



4HK1

YEM-H641



PC200-3 6D105

YEM-H642



6D95 PC200-5
OEM:6207-11-4882

YEM-H643



6D95 PC200-6

YEM-H656



6HK1

YEM-H657



4D31

YEM-H658



6D14/15/16

YEM-H644



PC200-6/6D102

YEM-H645



6D107排气管

YEM-H646



PC200-8 6754-11-5110

YEM-H659



6D31 新款 Now Type

YEM-H660



6D31 旧款 Old Type

YEM-H661



DH220-5 DB58

YEM-H647



6D108

YEM-H648



PC300-8
6745-11-5110
6745-11-5210

YEM-H649



PC400-7

YEM-H662



E312C

YEM-H663



S4K

YEM-H664



CAT E200B

YEM-H650



卡特C6.4

YEM-H651



卡特C9

YEM-H652



PC130-7

YEM-H665



CAT E320

YEM-H666



SK-8 J05E

YEM-H667



PC200-8
4946854

YEM-H668



PC200-3 U型管

























皮带轮 PULLEY

YEM-H669  PC200-5	YEM-H670  PC200-6 6D95	YEM-H671  PC200-6 6D102 6735-61-3280	YEM-H672  PC60 4D95	YEM-H673  PC120-6
YEM-H674  PC200-3	YEM-H675  PC300-3 PC400	YEM-H676  PC300-6 6D108	YEM-H677  EX200-5 6BG1	YEM-H678  4D31
YEM-H679  6D14	YEM-H680  6BD1	YEM-H681  6D31新款	YEM-H682  6D31旧款	YEM-H683  E200B
YEM-H684  E320B	YEM-H685  E320C	YEM-H686  4BD1 4BG1皮带轮 3389198	YEM-H687  4D95/6D95 双槽水泵皮带轮	YEM-H688  320C带中冷 水泵皮带轮
YEM-H689  PC200-6/6D95水泵皮带轮	YEM-H690  6D34水泵皮带轮	YEM-H691  新款 EC210/240/290 水泵皮带轮	YEM-H692  DH220-5 DB58	YEM-H693  E200B 水泵皮带轮(小)

皮带轮 PULLEY

YEM-H694  E200B 水泵皮带轮(大)	YEM-H695  EX120水泵皮带轮	YEM-H696  EX200水泵皮带轮	YEM-H697  6D102风扇皮带轮	YEM-H698  VOLVO210风扇皮带轮 (外径188)
YEM-H699  6D102水泵皮带轮 外径180	YEM-H700  4TNV94 双槽水泵皮带轮	YEM-H701  S6K 水泵皮带轮	YEM-H702  4JB1 曲轴皮带轮	YEM-H703  4D84/4D82 曲轴皮带轮
YEM-H704  PC200-3/5 风叶座	YEM-H705  6D102风扇支架 39112202	YEM-H706  6D102风扇支架	YEM-H707  风扇支架 3930955	YEM-H708  6D102风扇支架 3960076
YEM-H709  6D114风扇支架 3415603	YEM-H710  E320C新款 170x143x45φ	YEM-H711  E320C旧款	YEM-H712  6D24	YEM-H713  6D125
YEM-H714  4D31 168x100x34φ	YEM-H715  EX200-2	YEM-H716  4BD1	YEM-H717  DH60	YEM-H718  PC200-3 6D105 144x113x39φ

皮带轮 PULLEY

<p>YEM-H719</p>  <p>PC200-5 150×110×41Φ</p>	<p>YEM-H720</p>  <p>E320D风扇叶座</p>	<p>YEM-H721</p>  <p>6D102 220×54×19Φ</p>	<p>YEM-H722</p>  <p>4D95 150×66×43Φ</p>	<p>YEM-H723</p>  <p>PC120-6</p>
<p>YEM-H724</p>  <p>E330B空调皮带轮 640×38Φ×60</p>	<p>YEM-H725</p>  <p>Ex120水泵皮带轮 128×56×32Φ</p>	<p>YEM-H726</p>  <p>Ex200水泵皮带轮 148×72×32Φ</p>	<p>YEM-H727</p>  <p>E200B水泵皮带轮(大) 140×68×25Φ</p>	<p>YEM-H728</p>  <p>E200B水泵皮带轮(小) 132×70×25Φ</p>
<p>YEM-H729</p>  <p>PC200-5 水泵皮带轮</p>	<p>YEM-H730</p>  <p>PC200-5花篮 124×90×48Φ</p>	<p>YEM-H731</p>  <p>E320C 风叶座(新版)</p>	<p>YEM-H732</p>  <p>6D102风扇皮带轮</p>	<p>YEM-H733</p>  <p>6D102 单槽</p>
<p>YEM-H734</p>  <p>DH220-5 皮带轮</p>	<p>YEM-H735</p>  <p>25高 风叶垫块 3910128</p>	<p>YEM-H736</p>  <p>38高 风叶垫块 3910129</p>	<p>YEM-H737</p>  <p>63.5高 风叶垫块 3910131</p>	<p>YEM-H738</p>  <p>76高 风叶垫块 3915456</p>
<p>YEM-H739</p>  <p>S6K 风叶座</p>	<p>YEM-H740</p>  <p>E320C带中冷风叶铝座</p>	<p>YEM-H741</p>  <p>6D31风叶铝座</p>	<p>YEM-H742</p>  <p>E320C风扇支架(矮)</p>	<p>YEM-H743</p>  <p>E320C风扇支架(高)</p>

皮带轮 PULLEY

<p>YEM-H744</p>  <p>E320D电喷风扇支架</p>	<p>YEM-H745</p>  <p>E320D直喷风扇支架</p>	<p>YEM-H746</p>  <p>E325/329风扇支架</p>	<p>YEM-H747</p>  <p>PC60风叶铝座</p>
<p>YEM-H748</p>  <p>PC120-6风叶铝座</p>	<p>YEM-H749</p>  <p>PC200-6(6D102)风叶铝座</p>	<p>YEM-H750</p>  <p>PC200-7风叶铝座</p>	<p>YEM-H751</p>  <p>PC300-7风叶铝座</p>
<p>YEM-H752</p>  <p>PC300-8风叶铝座</p>	<p>YEM-H753</p>  <p>VOLVO风叶铝座</p>	<p>YEM-H754</p>  <p>6D24风叶座</p>	<p>YEM-H755</p>  <p>E320D 水泵皮带轮</p>
<p>YEM-H756</p>  <p>PC200-8</p>	<p>YEM-H757</p>  <p>R60-7</p>	<p>YEM-H758</p>  <p>CAT</p>	<p>YEM-H759</p>  <p>6D102风扇皮带轮 大孔外径160</p>
<p>YEM-H760</p>  <p>6D102风扇皮带轮 小孔外径160</p>	<p>YEM-H761</p>  <p>6D102双槽凸风扇皮带轮</p>	<p>YEM-H762</p>  <p>4D102风扇皮带轮 外径 130</p>	<p>YEM-H763</p>  <p>6D108风扇皮带轮总成</p>
<p>YEM-H764</p>  <p>6D34</p>	<p>YEM-H765</p>  <p>E320C 改小</p>	<p>YEM-H766</p>  <p>E200B</p>	<p>YEM-H767</p>  <p>6BD1</p>

皮带轮 PULLEY

<p>YEM-H768</p>  <p>VOLVO皮带轮</p>	<p>YEM-H769</p>  <p>ZX200-6</p>	<p>YEM-H770</p>  <p>6D114风扇皮带轮 外径230</p>	<p>YEM-H771</p>  <p>洋马空调轮单槽</p>
<p>YEM-H772</p>  <p>J05</p>	<p>YEM-H773</p>  <p>E320C 风叶座</p>	<p>YEM-H774</p>  <p>DH60-7</p>	<p>YEM-H775</p>  <p>PC200-6 6D95</p>
<p>YEM-H776</p>  <p>E32DC</p>	<p>YEM-H777</p>  <p>B3.3</p>	<p>YEM-H778</p>  <p>P200-6 6D95</p>	<p>YEM-H779</p>  <p>6D24风扇轮</p>
<p>YEM-H780</p>  <p>6BG1</p>	<p>YEM-H781</p>  <p>E320D12PK</p>	<p>YEM-H782</p>  <p>6D34</p>	<p>YEM-H783</p>  <p>4TNV94</p>
<p>YEM-H784</p>  <p>ZAX200-1</p>	<p>YEM-H785</p>  <p>E320C水泵轮</p>	<p>YEM-H786</p>  <p>4BG1</p>	<p>YEM-H787</p>  <p>4D95</p>
<p>YEM-H788</p>  <p>PC200-6 6D102</p>	<p>YEM-H789</p>  <p>DH55</p>	<p>YEM-H790</p>  <p>PC300-7 改小175mm</p>	<p>YEM-H791</p>  <p>6B61</p>

皮带轮 PULLEY

<p>YEM-H792</p>  <p>4HK1</p>	<p>YEM-H793</p>  <p>PC130-7</p>	<p>YEM-H794</p>  <p>PC200-7</p>	<p>YEM-H795</p>  <p>E320B</p>
<p>YEM-H796</p>  <p>Pc400 6D125</p>	<p>YEM-H797</p>  <p>J08</p>	<p>YEM-H798</p>  <p>4BD1</p>	<p>YEM-H799</p>  <p>PC360-7</p>
<p>YEM-H800</p>  <p>沃尔沃460</p>	<p>YEM-H801</p>  <p>E320C风叶座 改小</p>	<p>YEM-H802</p>  <p>6D31新款</p>	<p>YEM-H803</p>  <p>6D102风叶座</p>
<p>YEM-H804</p>  <p>ZAX450 1-13660360-0</p>	<p>YEM-H805</p>  <p>R455 QSM11 P3103513</p>	<p>YEM-H806</p>  <p>ZAX450 1-13660368-1</p>	<p>YEM-H807</p>  <p>6D24 风扇轮</p>
<p>YEM-H808</p>  <p>6D125</p>	<p>YEM-H809</p>  <p>日立4HK1 改小</p>	<p>YEM-H810</p>  <p>6D34</p>	<p>YEM-H811</p>  <p>住友4HK1 改小</p>
<p>YEM-H812</p>  <p>4JB1 8-94429746-0</p>			

皮带轮 PULLEY

<p>YEM-H813</p>  <p>6D24调节轮</p>	<p>YEM-H814</p>  <p>6HK1</p>	<p>YEM-H815</p>  <p>4HK1</p>	<p>YEM-H816</p>  <p>6BG1三槽</p>	<p>YEM-H817</p>  <p>4M40</p>
<p>YEM-H818</p>  <p>6D14</p>	<p>YEM-H819</p>  <p>7N1275</p>	<p>YEM-H820</p>  <p>E200B/320空调皮带轮</p>	<p>YEM-H821</p>  <p>320B/C/D空调皮带轮</p>	<p>YEM-H822</p>  <p>4M40曲轴皮带轮</p>
<p>YEM-H823</p>  <p>J05曲轴皮带轮</p>	<p>YEM-H824</p>  <p>皮带轮PC200-6</p>	<p>YEM-H825</p>  <p>SK350-8 四槽 皮带涨紧轮</p>	<p>YEM-H826</p>  <p>SK460 三槽 皮带涨紧轮</p>	<p>YEM-H827</p>  <p>Nt855 空调皮带轮</p>
<p>YEM-H828</p>  <p>4PK 大字空调皮带轮</p>	<p>YEM-H829</p>  <p>DH 空调轮好</p>	<p>YEM-H830</p>  <p>PC200-6 6D95 涨紧轮</p>	<p>YEM-H831</p>  <p>6D95调节轮</p>	<p>YEM-H832</p>  <p>E320C皮带涨紧轮</p>
<p>YEM-H833</p>  <p>E320D皮带涨紧轮</p>	<p>YEM-H834</p>  <p>PC360惰轮</p>	<p>YEM-H835</p>  <p>EC210/290 旧款 轴承座总成</p>	<p>YEM-H836</p>  <p>EC210/290 新款 轴承座总成</p>	<p>YEM-H837</p>  <p>DH55空调皮带轮</p>

皮带轮 PULLEY

<p>YEM-H838</p>  <p>4BT皮带涨紧轮(C3937553)</p>	<p>YEM-H839</p>  <p>3194086 6731-61-4510 PC200-6/7 PC220-6/7 6D102皮带涨紧轮</p>	<p>YEM-H840</p>  <p>2482230 3936213 6CT 皮带涨紧轮</p>	<p>YEM-H841</p>  <p>6CT8.3反方向皮带涨紧轮</p>	<p>YEM-H842</p>  <p>PC200-8/6D107 不带槽</p>
<p>YEM-H843</p>  <p>PC200-8/6D107 带槽 6754-61-4110</p>	<p>YEM-H844</p>  <p>PC360-7惰轮 6742-01-523</p>	<p>YEM-H845</p>  <p>PC300-6皮带涨紧轮</p>	<p>YEM-H846</p>  <p>E325皮带涨紧轮</p>	<p>YEM-H847</p>  <p>211-7895 E345皮带涨紧轮</p>
<p>YEM-H848</p>  <p>VOLVO皮带涨紧轮 Renault 18K09</p>	<p>YEM-H849</p>  <p>VOLVO210皮带涨紧轮 210-290</p>	<p>YEM-H850</p>  <p>VOLVO360/460皮带涨紧轮</p>	<p>YEM-H851</p>  <p>VOLVO Fh12 8149855</p>	<p>YEM-H852</p>  <p>VOLVO350皮带涨紧轮</p>
<p>YEM-H853</p>  <p>VOLVO240 皮带涨紧轮</p>	<p>YEM-H854</p>  <p>EC380皮带涨紧轮</p>	<p>YEM-H855</p>  <p>EC480皮带涨紧轮</p>	<p>YEM-H856</p>  <p>EC480惰轮总成</p>	<p>YEM-H857</p>  <p>3102888/3400885 皮带涨紧轮</p>
<p>YEM-H858</p>  <p>雷诺皮带轮 RENAULT</p>	<p>YEM-H859</p>  <p>JCB 老款</p>	<p>YEM-H860</p>  <p>JCB新款不带槽</p>	<p>YEM-H861</p>  <p>JCB新款带槽</p>	<p>YEM-H862</p>  <p>E336D惰轮 EC360惰轮</p>
<p>YEM-H863</p>  <p>EC480惰轮</p>	<p>YEM-H864</p>  <p>日立空调皮带轮</p>	<p>YEM-H865</p>  <p>卡特/现代空调皮带轮</p>	<p>YEM-H866</p>  <p>CAT 空调轮好</p>	<p>YEM-H867</p>  <p>EX 空调轮好</p>

油门线、熄火线
ACCELERATOR CABLE/STOP SWITCH WIRE



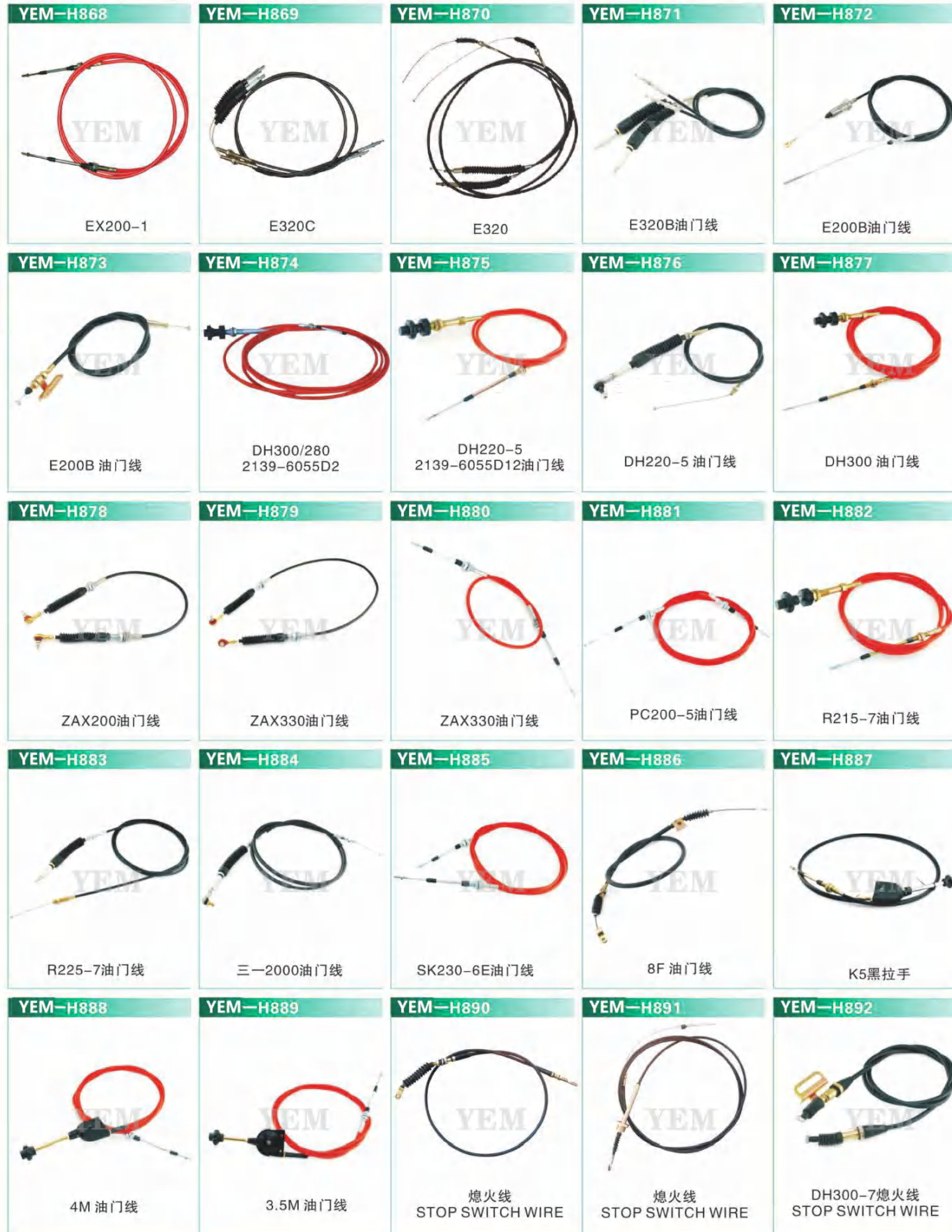

















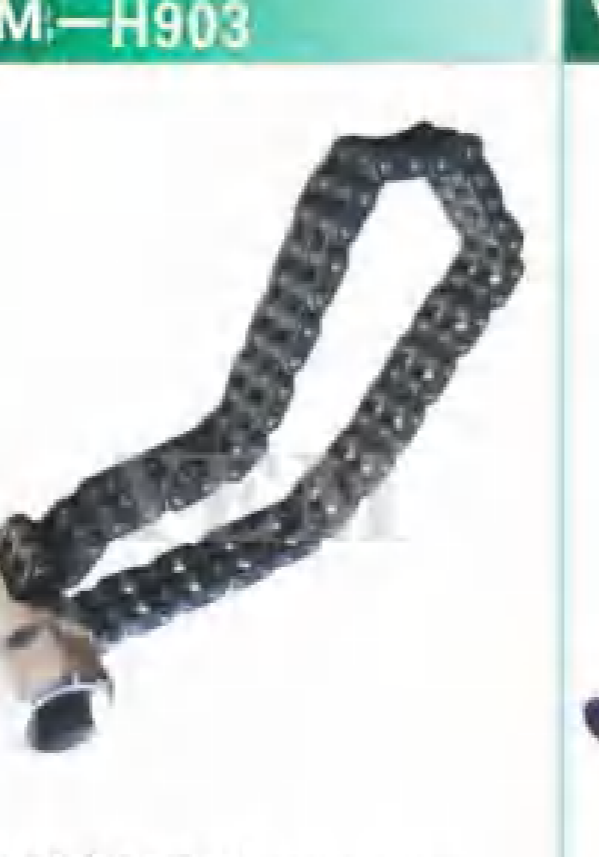







油门线、熄火线目录
ACCELERATOR CABLE CATALOG



机型	机型	机型	熄火线机型
E120	HD1251 360	R290	DH220-3
E120B	HD250	R55	DH220-5
E200B	HD450	SH120	DH300
E240	HD512	SH200	DH300-5
E307	HD700-5	SH280	E200B
E307B	HD700-7	SK07N2	E312B
E312	HD800	SK120	E320
E312B	HD820	SK200	E320B
E320	HD900-7	SK200-3	E320C
E320B	PC120	SK200-5	EX200-2
E320C	PC120-5	SK200-6	EX200-3
E320V2	PC200-3	SK220	EX200-5
E330	PC200-5	SK230	EX300
E340	PC200-6	SK230-6	HD700-7
EX120	PC200-7	SK300	HD900-7
EX120-3	PC220-6	SK60-6	PC120
EX120-5	PC300-3	ZAX200	PC00-3
EX200-1	PC300-5	ZAX230	PC200-5
EX200-2	PC300-6	ZAX330	R200
EX200-3	PC400-5	ZAX230-6	R210
EX200-5	PC60-6	ZAX270-5	R220-5
EX200-6	PC60-7	DH200-5	SH120
EX220-5	R130	DH200-3	SH200
EX230-6	R210-5	DH220-5	SK200-3
EX300-2	R220-5	DH280	SK220-5
EX300-3	R200-5	DH300-5	SK230
EX300-5	R215-7	DH300-7	SK300
HD1250	R225-7	DH55	ZAX200
			ZAX240

工具类 TOOLS

黄油枪 GREASE GUN

YEM-H893  活塞扳手	YEM-H894  钢皮扳手	YEM-H895  皮带扳手	YEM-H896  铁链扳手	YEM-H897  白布皮带扳手 加长	YEM-H898  SK-8扳手
YEM-H899  皮带扳手 加长	YEM-H900  白布扳手	YEM-H901  手铸扳手 小	YEM-H902  手铸扳手 大 Filler wrench	YEM-H903  双链扳手 Spanner	YEM-H904  打斗齿工具
YEM-H905  三爪扳手	YEM-H906  CAT专用扳手	YEM-H907  KWT-41	YEM-H908  O型圈托勾	YEM-H909  梅花扳手 Round key	YEM-H910  螺纹锁固剂 THREAD LOCKER
YEM-H911  密封胶 红/黑/白 Sealant red/black	YEM-H912  内六角套筒 Inside hex sleeve	YEM-H913  电子吸油泵	YEM-H914  格航钢质新标准扳手	YEM-H915  梅花扳手 Round key	YEM-H916  液压表(4表)
YEM-H917  液压表(3表)	YEM-H917A  三通接头完整版	YEM-H917B  三通接头简单版	YEM-H917C  液压表三通接头二合一	YEM-H917D  自喷漆	

YEM-H918  广瑞600CC黄油枪	YEM-H919  力博海尔900CC黄油枪	YEM-H920  GB盒装黄油枪	YEM-H921  CAT600CC黄油枪
YEM-H922  CAT黄油枪 GREASE GUN	YEM-H923  Grease Gun	YEM-H924  Grease Gun	YEM-H925  Grease Gun
YEM-H926  Grease Gun	YEM-H927  Grease Gun	YEM-H928  力高黄油枪 GREASE GUN	YEM-H929  力高黄油枪 GREASE GUN
YEM-H930  彼特11209黄油枪 GREASE GUN	YEM-H931  博士黄油枪 GREASE GUN	YEM-H932  RCAT黄油枪系列 GREASE GUN	YEM-H933  12V/24V 电动计量柴油加油泵 Power-driver Fuel Pump
YEM-H934  脚踏式黄油机 5升/8升 Pedal Grease Machine	YEM-H935  脚踏式黄油机 5升/8升 Pedal Grease Machine	YEM-H936  广瑞自吸泵 12V/24V SELF-SUCTION Pump	YEM-H937  上海博文自吸泵 12V/24V SELF-SUCTION Pump

<p>YEM-H938</p>  <p>LED方灯 (5寸黑色) LED SQUARE LAMP</p>	<p>YEM-H939</p>  <p>LED方灯 (5寸黄色) LED SQUARE LAMP</p>	<p>YEM-H940</p>  <p>LED方灯 (5寸15珠) LED SQUARE LAMP</p>	<p>YEM-H941</p>  <p>LED圆灯(5寸) LED ROUND LAMP</p>
<p>YEM-H942</p>  <p>LED方灯 (4寸8珠) LED SQUARE LAMP</p>	<p>YEM-H943</p>  <p>LED圆灯 (4寸7珠) LED ROUND LAMP</p>	<p>YEM-H944</p>  <p>LED方灯 (4寸9珠) LED SQUARE LAMP</p>	<p>YEM-H945</p>  <p>LED圆灯 (4寸9珠) LED ROUND LAMP</p>
<p>YEM-H946</p>  <p>LED方灯 (4寸16珠) LED SQUARE LAMP</p>	<p>YEM-H947</p>  <p>LED方灯 (4寸8珠) LED SQUARE LAMP</p>	<p>YEM-H948</p>  <p>LED圆灯 (4寸8珠) LED ROUND LAMP</p>	<p>YEM-H949</p>  <p>LED方灯 (3寸4珠) LED SQUARE LAMP</p>
<p>YEM-H950</p>  <p>LED圆灯 (3寸3珠) LED ROUND LAMP</p>	<p>YEM-H951</p>  <p>LED长条灯 LED LAMP</p>	<p>YEM-H952</p>  <p>铁壳方灯 LRON LAMP</p>	<p>YEM-H953</p>  <p>塑料方灯 RUBBER LAMP</p>
<p>YEM-H954</p>  <p>铁壳方灯(可换H3) LRON LAMP(H3)</p>	<p>YEM-H955</p>  <p>铁壳方灯(可换H4) LRON LAMP(H4)</p>	<p>YEM-H956</p>  <p>铁壳方灯(双线) LRON LAMP</p>	<p>YEM-H957</p>  <p>铁壳方灯(可换H4) 三线 LRON LAMP(H4)</p>

<p>YEM-H958</p>  <p>塑料方灯 (可换H3) RUBBER LAMP(H3)</p>	<p>YEM-H959</p>  <p>塑料方灯(可换H4) RUBBER LAMP (H4)</p>	<p>YEM-H960</p>  <p>疝气铁灯 HERNIA LAMP</p>	<p>YEM-H961</p>  <p>塑料方灯(黑色) RUBBER LAMP(BLACK)</p>
<p>YEM-H962</p>  <p>大字/现代专用铁灯 DH/R LRON LAMP</p>	<p>YEM-H963</p>  <p>大字/现代专用铁灯(可换H4) DH/R LRON LAMP(H4)</p>	<p>YEM-H964</p>  <p>大字/现代专用铁灯(可换H3) DH/R LRON LAMP(H3)</p>	<p>YEM-H965</p>  <p>铁圆灯(黄色) LRON LAMP</p>
<p>YEM-H966</p>  <p>塑料圆灯 RUBBER LAMP</p>	<p>YEM-H967</p>  <p>铁圆灯(银白) LRON LAMP(SILERY WHITE)</p>	<p>YEM-H968</p>  <p>铁圆灯(可360°转动) LRON LAMP</p>	<p>YEM-H969</p>  <p>卡特方灯(黑色) CAT LAMP</p>
<p>YEM-H970</p>  <p>卡特方灯(黄色) CAT LAMP</p>	<p>YEM-H971</p>  <p>日立大灯 HITACHI LAMP</p>	<p>YEM-H972</p>  <p>日立大灯-黄 HITACHI LAMP</p>	<p>YEM-H973</p>  <p>日立工作灯 EX LAMP</p>
<p>YEM-H974</p>  <p>日立工具箱灯-黄 EX LAMP</p>	<p>YEM-H975</p>  <p>叉车大灯 LAMP</p>	<p>YEM-H976</p>  <p>小挖大灯 12V/24V LAMP</p>	<p>YEM-H977</p>  <p>小松大灯 PC LAMP</p>

YEM-H978



2000型小方灯
LAMP

YEM-H979



小方灯
LAMP

YEM-H980



HID大灯
HID LAMP

YEM-H981



沃尔沃灯
VOLVO
VOLVO LAMP

YEM-H998



卡特信号灯 (白色)
LAMP

YEM-H999



卡特信号灯 (黄色)
LAMP

YEM-H1000



信号灯 (红色)
LAMP

YEM-H1001



双面灯
LAMP

YEM-H982



VOLVO-103(带插头)

YEM-H983



VOLVO-103(不带插头)

YEM-H984



6101 A:(白)聚 B:(黑)泛

YEM-H985



VOLVO 95X95X85(mm)

YEM-H1002



单面转向灯
LAMP

YEM-H1003



JCB灯
JCB LAMP

YEM-H1004



VOLVO装载机灯
VOLVO LAMP

YEM-H1005



柳工灯
LAMP

YEM-H986



6152 A:(白)泛 B:(黑)聚

YEM-H987



6273 A:30 B:60

YEM-H988



SK200-3尾灯
TAIL-LIGHT

YEM-H989



SK200-6尾灯
TAIL-LIGHT

YEM-H1006



信号灯
LAMP

YEM-H1007



JCB尾灯
JCB LAMP

YEM-H1008



装载机灯
LAMP

YEM-H1009



合力尾灯
LAMP

YEM-H990



厦工组合灯
LAMP

YEM-H991



组合灯 厦工装载机
SANY LAMP

YEM-H992



JCB-101组合大灯
JCB LAMP

YEM-H993



JCB-103组合大灯
JCB LAMP

YEM-H1010



杭叉尾灯
LAMP

YEM-H1011



柳工三色灯
LAMP

YEM-H1012



现代小灯
LAMP

YEM-H1013



A 警示灯
LAMP B 闪灯
LAMP

YEM-H994



现代轮控组合大灯
HYUNDAI LAMP

YEM-H995



柳工组合大灯
LIUGONG LAMP

YEM-H996



柳工组合大灯
LIUGONG LAMP

YEM-H997



组合大灯
LAMP

YEM-H1014



飞利浦灯泡(H3)
LAMP

YEM-H1015



飞利浦灯泡(H4)
LAMP(H4)

YEM-H1016



真空灯芯
LAMP WICK

YEM-H1017

































可换H4方灯芯
LAMPWICK









表系列 METER

打链咀 ADJUST FITTING

<p>YEM-H1018</p>  <p>通用型计时器 TIME METER</p>	<p>YEM-H1019</p>  <p>卡特计时器 CAT TIME METER</p>	<p>YEM-H1020</p>  <p>卡特320D计时器 E320D 285-9075 TIME METER</p>	<p>YEM-H1021</p>  <p>大字计时器 DH220-5/7 1514-7012 TIME METER</p>	<p>YEM-H1022</p>  <p>VOLVO计时器 VOLVO TIME METER</p>
<p>YEM-H1023</p>  <p>神钢计时器 KOBELCO YTS5S0006P1 TIME METER</p>	<p>YEM-H1024</p>  <p>现代计时器 HYUNDAI 21N4-11070 TIME METER</p>	<p>YEM-H1025</p>  <p>通用水温表(机械式) WATER TEMP METER</p>	<p>YEM-H1026</p>  <p>水温表(仿印度) 1W7550 WATER TEMP METER</p>	<p>YEM-H1027</p>  <p>水温表 1W7550 WATER TEMP METER</p>
<p>YEM-H1028</p>  <p>小松-5/7水温表(液晶式) PC200-5/7 WATER TEMP METER</p>	<p>YEM-H1029</p>  <p>小松-6水温表(液晶式) PC200-6/6D102 WATER TEMP METER</p>	<p>YEM-H1030</p>  <p>日立水温表(液晶式) EX200-2/3/5 WATER TEMP METER</p>	<p>YEM-H1031</p>  <p>卡特水温表(液晶式) E320B/C WATER TEMP METER</p>	<p>YEM-H1032</p>  <p>神钢水温表(液晶式) SK200-3/6 WATER TEMP METER</p>
<p>YEM-H1033</p>  <p>大字水温表(液晶式) DH200-5/7 WATER TEMP METER</p>	<p>YEM-H1034</p>  <p>住友水温表(液晶式) SH200 WATER TEMP METER</p>	<p>YEM-H1035</p>  <p>VOLVO水温表(液晶式) VOLVO WATER TEMP METER</p>	<p>YEM-H1036</p>  <p>通用单脚水温表(液晶式) WATER TEMP METER</p>	
<p>YEM-H1037</p>  <p>通用双脚水温表(液晶式) WATER TEMP METER</p>	<p>YEM-H1038</p>  <p>液晶彩屏显示水温表 WATER TEMP METER</p>	<p>YEM-H1039</p>  <p>机油表 1W0702 OIL TEMP METER</p>	<p>YEM-H1040</p>  <p>油温表 OIL TEMP METER</p>	
<p>YEM-H1041</p>  <p>通用计时器 (可调时间)</p>	<p>YEM-H1042</p>  <p>E320D新款计时器 (可调时间)</p>	<p>YEM-H1043</p>  <p>E320D计时器 (可调时间)</p>	<p>YEM-H1044</p>  <p>大字计时器 (可调时间)</p>	

<p>YEM-H1045</p>  <p>小松 PC200 07959-20001</p>	<p>YEM-H1046</p>  <p>小松大头 PC60/PC120 203-30-42260</p>	<p>YEM-H1047</p>  <p>EX55/EX60 030766</p>	<p>YEM-H1048</p>  <p>Ex200 9061173 4255055R</p>	<p>YEM-H1049</p>  <p>VOLVO/R60-7</p>
<p>YEM-H1050</p>  <p>ZAX200 4255055</p>	<p>YEM-H1051</p>  <p>卡特 095-2927 095-9291</p>	<p>YEM-H1052</p>  <p>卡特大头 2S-5925</p>	<p>YEM-H1053</p>  <p>SK 2444P803</p>	<p>YEM-H1054</p>  <p>神钢大头 20000</p>
<p>YEM-H1055</p>  <p>加藤 117-32601000</p>	<p>YEM-H1056</p>  <p>SH住友 FHA0026</p>	<p>YEM-H1057</p>  <p>DH55</p>	<p>YEM-H1058</p>  <p>DH45</p>	<p>YEM-H1059</p>  <p>DH220 2420-1242A</p>
<p>YEM-H1060</p>  <p>R60-5/R55</p>	<p>YEM-H1061</p>  <p>R225-7</p>	<p>YEM-H1062</p>  <p>R215-7</p>	<p>YEM-H1063</p>  <p>现代200 E181-2013</p>	<p>YEM-H1064</p>  <p>玉柴平头</p>
<p>YEM-H1065</p>  <p>玉柴尖头</p>	<p>YEM-H1066</p>  <p>PC120不锈钢</p>	<p>YEM-H1067</p>  <p>PC不锈钢</p>	<p>YEM-H1068</p>  <p>ZAX55不锈钢</p>	<p>YEM-H1069</p>  <p>EX不锈钢</p>
<p>YEM-H1070</p>  <p>SK/CAT不锈钢</p>	<p>YEM-H1071</p>  <p>DH不锈钢</p>	<p>YEM-H1072</p>  <p>R220不锈钢</p>	<p>YEM-H1073</p>  <p>EC大头不锈钢</p>	<p>YEM-H1074</p>  <p>ZAX200-5G 打链咀</p>

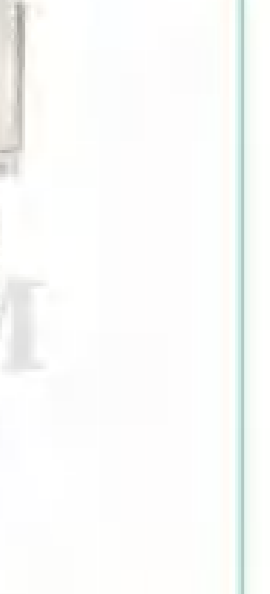
打链咀 ADJUST FITTING

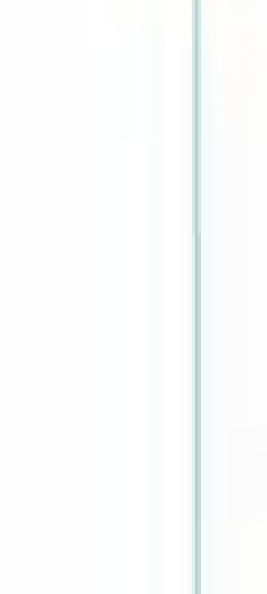
 YEM-H1075 PC130(S27) 20M-30-31240	 YEM-H1076 PC60/EX50 4618093	 YEM-H1077 PC07959-20001	 YEM-H1078 PC120	 YEM-H1079 日立直嘴	
 YEM-H1080 日立120	 YEM-H1081 日立EX55	 YEM-H1082 EX200-3 4250350	 YEM-H1083 EX200-2 4255055	 YEM-H1084 现代R445	
 YEM-H1085 现代R215-9	 YEM-H1086 现代R225-7	 YEM-H1087 现代R215-7	 YEM-H1088 R60-7 811-20090 CYD60	 YEM-H1089 CAT 095-2927	
 YEM-H1090 CAT 2S-5925	 YEM-H1091 大宇DH55	 YEM-H1092 大宇DH-9	 YEM-H1093 DH220 2420-1242	 YEM-H1094 大宇尖头	 YEM-H1095 SK 2444D803
 YEM-H1096 SK60	 YEM-H1097 VOLVO 14526406 55B/60C/140B	 YEM-H1098 VOLVO 14531520	 YEM-H1099 玉柴尖头135 M16*1.5	 YEM-H1100 玉柴平头/玉柴85 开元85.70/福田85	 YEM-H1101 玉柴尖头135 M14*1.5
 YEM-H1102 SHS	 YEM-H1103 柳工922D	 YEM-H1104 久保田 U-15-3S	 YEM-H1105 加藤HD82C	 YEM-H1106 福田/雷沃45	 YEM-H1107 JCB370

黄油嘴 BUTTER MOUTH 万向节 UNIVERSAL COUPLING

 GB-H1108 Φ10进口 180° /90° /45°	 GB-H1109 180° /90° /45° (12, 13, 14, 16)	 GB-H1110 180° /90° (10mm)	 GB-H1111 45° (10mm) 135° (8mm)	 GB-H1112 90° (8mm) 180° (8mm)
 GB-H1113 软管	 GB-H1114 硬管	 GB-H1115 MOBIL 连体美孚油枪嘴	 GB-H1116 尖嘴	 GB-H1117 重型油枪嘴
 YEM-H1118 台湾带帽油枪嘴	 YEM-H1119 意大利油枪嘴 ITALY Grease Fitting	 YEM-H1120 瑞典B31油枪嘴 SWEDAN Grease Fitting	 YEM-H1121 西德油枪嘴 WEST GERMANY Grease Fitting	 YEM-H1122 Ak优质枪头 Nozzle
 YEM-H1123 小松200 细牙	 YEM-H1124 小松120	 YEM-H1125 老日立粗牙 新日立细牙、 ZAX	 YEM-H1126 神钢、加藤	 YEM-H1127 卡特、大宇、现代、住友 粗牙
 YEM-H1128 赫斯克、三一	 YEM-H1129 力士乐万向节	 YEM-H1130 球头	 YEM-H1131 牛眼内牙 6-12mm	 YEM-H1132 牛眼外牙 6-12mm
 YEM-H1133 A 5mm B 6mm 球头 Bolt Copper	 YEM-H1134 8mm R/L 10mm R/L 球头 Bolt Copper	 YEM-H1135 10转6mm 6mm 球头 Bolt Copper	 YEM-H1136 8mm 4056018 10mm 4056019 球头 Bolt Copper	 YEM-H1137 6mm 20Y-43-12180 10mm 20Y-43-12180

盖类系列 TANK COVER SERIES

盖类系列 TANK COVER SERIES

<p>YEM-H1138</p>  <p>EX KB-2164</p>	<p>YEM-H1139</p>  <p>Dh300 KB-2132</p>	<p>YEM-H1140</p>  <p>VOLVO KB-2165</p>	<p>YEM-H1141</p>  <p>SH KB-2163</p>
<p>YEM-H1142</p>  <p>HD KB-2162</p>	<p>YEM-H1143</p>  <p>PC200/300 KB-2161</p>	<p>YEM-H1144</p>  <p>SK-6/8 KB-2160</p>	<p>YEM-H1145</p>  <p>PC 油箱盖 OEM:20Y-04-11160 21050-21200</p>
<p>YEM-H1146</p>  <p>EX 油箱盖 OEM:4361638</p>	<p>YEM-H1147</p>  <p>ZAX 油箱盖</p>	<p>YEM-H1148</p>  <p>DS-1593 320 油箱盖</p>	<p>YEM-H1149</p>  <p>E330C 油箱盖 OEM:7X7700</p>
<p>YEM-H1150</p>  <p>SK 油箱盖 OEM:2246U260F1 2444R1047</p>	<p>YEM-H1151</p>  <p>SH 油箱盖</p>	<p>YEM-H1152</p>  <p>HD 油箱盖</p>	<p>YEM-H1153</p>  <p>DH 油箱盖</p>
<p>YEM-H1154</p>  <p>三一 油箱盖</p>	<p>YEM-H1155</p>  <p>E320B/C高级柴油箱盖</p>	<p>YEM-H1156</p>  <p>DH高级柴油箱盖</p>	<p>YEM-H1157</p>  <p>EX高级柴油箱盖</p>

<p>YEM-H1158</p>  <p>PC高级柴油箱盖</p>	<p>YEM-H1159</p>  <p>SH住友高级柴油箱盖</p>	<p>YEM-H1160</p>  <p>SK高级柴油箱盖</p>	<p>YEM-H1161</p>  <p>SK油箱盖 加厚型不锈钢</p>	<p>YEM-H1162</p>  <p>SH油箱盖 加厚型不锈钢</p>
<p>YEM-H1163</p>  <p>HD油箱盖 加厚型不锈钢</p>	<p>YEM-H1164</p>  <p>DH油箱盖 加厚型不锈钢</p>	<p>YEM-H1165</p>  <p>PC油箱盖 加厚型不锈钢</p>	<p>YEM-H1166</p>  <p>EX油箱盖 加厚型不锈钢</p>	<p>YEM-H1167</p>  <p>SK-8 油箱盖 YN7V00002F4</p>
<p>YEM-H1168</p>  <p>SH 油箱盖</p>	<p>YEM-H1169</p>  <p>DH 油箱盖</p>	<p>YEM-H1170</p>  <p>HD油箱盖</p>	<p>YEM-H1171</p>  <p>R 现代/DH55 SK07 油箱盖 OEM:311V4-02120 E131-1038 2188-9005 2188-9006</p>	<p>YEM-H1172</p>  <p>HYUNDAI 油箱盖</p>
<p>YEM-H1173</p>  <p>HYUNDAI 油箱盖</p>	<p>YEM-H1174</p>  <p>现代/DH55 SK07柴油箱盖 311V4-02120 E131-1038 2188-9005 2188-9006</p>	<p>YEM-H1175</p>  <p>ZAX</p>	<p>YEM-H1176</p>  <p>沃尔沃油箱盖</p>	<p>YEM-H1177</p>  <p>三菱油箱盖(胶)</p>
<p>YEM-H1178</p>  <p>斗山300</p>	<p>YEM-H1179</p>  <p>SK3孔油箱盖</p>	<p>YEM-H1180</p>  <p>SANNY三一-挖机柴油箱盖 FUEL TANK CAP</p>	<p>YEM-H1181</p>  <p>柴油箱盖R215-7/9</p>	<p>YEM-H1182</p>  <p>JCB 油箱盖 老款</p>

盖类系列 TANK COVER SERIES

盖类系列 TANK COVER SERIES





<p>YEM-H1183</p>  <p>PC60 油箱盖 20U-04-21360</p>	<p>YEM-H1184</p>  <p>PC 油箱盖 20Y-04-11160 21050-21200</p>	<p>YEM-H1185</p>  <p>EX 油箱盖 4361638</p>	<p>YEM-H1186</p>  <p>E320 油箱盖 (DS-1593)</p>	<p>YEM-H1187</p>  <p>E320BC 7X7700柴油箱盖 Fuel tank cap</p>
<p>YEM-H1188</p>  <p>SK 油箱盖 2246U260F1 2444R1047</p>	<p>YEM-H1189</p>  <p>JCB新款</p>	<p>YEM-H1190</p>  <p>JCB路虎柴油箱盖</p>	<p>YEM-H1191</p>  <p>雷沃油箱盖</p>	<p>YEM-H1192</p>  <p>利勃海尔</p>
<p>YEM-H1193</p>  <p>久保田</p>	<p>YEM-H1194</p>  <p>ZAX-5油箱盖</p>	<p>YEM-H1195</p>  <p>国产机 液压盖</p>	<p>YEM-H1196</p>  <p>PC200-5液压油箱盖 20Y-60-11440</p>	<p>YEM-H1197</p>  <p>PC200-6液压油箱盖 17A-60-11310</p>
<p>YEM-H1198</p>  <p>大字液压油箱盖 K1012685</p>	<p>YEM-H1199</p>  <p>VOLVO R215-7呼吸滤液压油箱盖 208-60-51800</p>	<p>YEM-H1200</p>  <p>EX200-1/SH265/KATO通用 4178684 4222874液压油箱盖</p>	<p>YEM-H1201</p>  <p>EX200-2液压油箱盖 4294701</p>	<p>YEM-H1202</p>  <p>高 矮 E320 E330 液压油箱盖</p>
<p>YEM-H1203</p>  <p>PC60柴油盖 19m-04-11220 Fuel tank cap</p>	<p>YEM-H1204</p>  <p>PC200-3胶柴油盖 07091-21200 07051-00000 Fuel tank cap</p>	<p>YEM-H1205</p>  <p>洋马机油盖 洋马连接管</p>	<p>YEM-H1206</p>  <p>VOLVO360机油盖</p>	<p>YEM-H1207</p>  <p>4D95 机油盖</p>

<p>YEM-H1208</p>  <p>6224-11-8610 PC机油盖</p>	<p>YEM-H1209</p>  <p>小松机油盖</p>	<p>YEM-H1210</p>  <p>6D102 6D114发动机前盖</p>	<p>YEM-H1211</p>  <p>6D102气门室盖机油盖</p>	<p>YEM-H1212</p>  <p>机油盖 ZAX 8-94399723-0</p>
<p>YEM-H1213</p>  <p>日立9-11751045-1</p>	<p>YEM-H1214</p>  <p>SK机油盖</p>	<p>YEM-H1215</p>  <p>SK-8J05 J08机油盖</p>	<p>YEM-H1216</p>  <p>4BD1机油盖</p>	<p>YEM-H1217</p>  <p>DH机油盖</p>
<p>YEM-H1218</p>  <p>DH机油盖</p>	<p>YEM-H1219</p>  <p>4HK1 6HK1机油盖</p>	<p>YEM-H1220</p>  <p>EOM:4895459机油盖</p>	<p>YEM-H1221</p>  <p>4JG1机油盖</p>	<p>YEM-H1222</p>  <p>卡特机油盖</p>
<p>YEM-H1223</p>  <p>三菱机油盖</p>	<p>YEM-H1224</p>  <p>4BD1机油盖</p>	<p>YEM-H1225</p>  <p>帕金斯</p>	<p>YEM-H1226</p>  <p>EC机油盖</p>	<p>YEM-H1227</p>  <p>小松300-7/360-7 发动机机油盖 OEM:207-01-31150</p>
<p>YEM-H1228</p>  <p>小松200-7/8 回转加机油口盖</p>	<p>YEM-H1229</p>  <p>EC210 付水箱盖 VOLVO360 付水箱盖</p>	<p>YEM-H1230</p>  <p>不锈钢水箱盖 中 4152858 20Y-03-22110</p>	<p>YEM-H1231</p>  <p>小水箱盖</p>	<p>YEM-H1232</p>  <p>中水箱盖 205-03-71280</p>

盖类系列 TANK COVER SERIES

付水箱 WIPER WATER TANK

YEM-H1233  大水箱盖	YEM-H1234  精品大	YEM-H1235  大水箱盖	YEM-H1236  外贸水箱盖	YEM-H1237  电子感应水箱盖
YEM-H1238  电子感应水箱盖	YEM-H1239  电子感应水箱盖	YEM-H1240  R/DH55小炮 油箱盖防盗锁	YEM-H1241  PC/SK/DH/EX 油箱盖防盗锁	YEM-H1242  R/DH55小炮 油箱盖防盗锁
YEM-H1243  徐工 柳工 国产机	YEM-H1244  油箱盖 防盗锁	YEM-H1245  E312废气盖	YEM-H1246  PC废气盖 6150-21-6750	YEM-H1247  S6K废气盖
YEM-H1248  DH300-5 大字废气盖	YEM-H1249  R现代废气盖	YEM-H1250  DH220-5 铁废气盖	YEM-H1251  PC	YEM-H1252  R现代 DH
YEM-H1253  PC200-6/7液口盖	YEM-H1254  现代 4434017	YEM-H1255  SK/Ex200/沃尔沃呼吸滤 14561585	YEM-H1256  VOLVO360	YEM-H1257  PC200-8
YEM-H1258  液压油箱盖	YEM-H1259  D6E	YEM-H1260  D7D		

YEM-H1261  副水箱 PC40	YEM-H1262  PC60圆	YEM-H1263  PC/HD	YEM-H1264  PC400	YEM-H1265  EX/CAT
YEM-H1266  ZAX70	YEM-H1267  ZAX300	YEM-H1268  EX	YEM-H1269  DH 小	YEM-H1270  DH 大
YEM-H1271  DH55水壶 DH55 RADIATOR	YEM-H1272  DH60水壶 DH60 RADIATOR	YEM-H1273  DX60	YEM-H1274  E330/336	YEM-H1275  三一
YEM-H1276  SK超8	YEM-H1277  SK350-8	YEM-H1278  神钢附水箱 022810-8491	YEM-H1279  VOLVO大	YEM-H1280  VOLVO 17214674 好
YEM-H1281  VOLVO	YEM-H1282  VOLVO55	YEM-H1283  VOLVO60	YEM-H1284  VOLVO700	YEM-H1285  VOLVO 小
YEM-H1286  E320C水壶	YEM-H1287  副水箱 现代R60-5	YEM-H1288  副水箱 R220-5	YEM-H1289  R60-7/9	YEM-H1290  现代215-9
YEM-H1291  EC360	YEM-H1292  加藤/小松附水箱(不带线) 203-03-61640	YEM-H1293  RADIATOR水壶		

锁系列 LOCK

<p>YEM-H1294</p>  <p>小松液压泵门锁20Y-54-71491 PCHydraulicpumpkey</p>	<p>YEM-H1295</p>  <p>日立液压泵门锁 EXHydraulicpumpkey</p>	<p>YEM-H1296</p>  <p>卡特液压泵门锁 CATHydraulicpumpkey</p>	<p>YEM-H1297</p>  <p>神钢液压泵门锁 SKHydraulicpumpkey</p>
<p>YEM-H1298</p>  <p>SH液压泵门锁 SHHydraulicpumpkey</p>	<p>YEM-H1299</p>  <p>HD液压泵门锁 HDHYDRAULICPUMPKEY</p>	<p>YEM-H1300</p>  <p>大宇液压泵门锁 DHHydraulicpumpkey</p>	<p>YEM-H1301</p>  <p>右 左 沃尔沃液压泵门锁14508850 VOLVOHydraulicpumpkey</p>
<p>YEM-H1302</p>  <p>ZAX液压泵门锁 ZAXHydraulicpumpkey</p>	<p>YEM-H1303</p>  <p>R210-5新款液压泵门锁 RHydraulicpumpkey</p>	<p>YEM-H1304</p>  <p>现代液压泵门锁 RHydraulicpumpkey</p>	<p>YEM-H1305</p>  <p>神钢-6/460/480机盖锁</p>
<p>YEM-H1306</p>  <p>小松机头锁205-54-76260 PCEnginecoverlock</p>	<p>YEM-H1307</p>  <p>EX机头锁Enginecoverlock</p>	<p>YEM-H1308</p>  <p>卡特机头锁1R-9958 CATEnginecoverlock</p>	<p>YEM-H1309</p>  <p>SK机头锁2427R30202 Enginecoverlock</p>
<p>YEM-H1310</p>  <p>ZAX机头锁 ZAX Enginecoverlock</p>	<p>YEM-H1311</p>  <p>三一机头锁 Enginecoverlock</p>	<p>YEM-H1312</p>  <p>R机头锁 Enginecoverlock</p>	<p>YEM-H1313</p>  <p>DH机头锁 Enginecoverlock</p>
<p>YEM-H1314</p>  <p>VOLVO机头锁14521945 Enginecoverlock</p>	<p>YEM-H1315</p>  <p>住友机头锁 SH Enginecoverlock</p>	<p>YEM-H1316</p>  <p>加藤机头锁 HD Enginecoverlock</p>	

锁系列 LOCK

<p>YEM-H1317</p>  <p>PC200-5驾驶室门锁总成 20Y-54-14520 20Y-54-71642</p>	<p>YEM-H1318</p>  <p>PC200-6驾驶室门锁总成</p>	<p>YEM-H1319</p>  <p>PC200-7驾驶室门锁总成</p>	
<p>YEM-H1320</p>  <p>PC200-8驾驶室门锁总成</p>	<p>YEM-H1321</p>  <p>EX70驾驶室门锁总成</p>	<p>YEM-H1322</p>  <p>EX-2驾驶室门锁总成</p>	<p>YEM-H1323</p>  <p>EX200-5驾驶室门锁总成 4369631 4362135</p>
<p>YEM-H1324</p>  <p>ZAX直喷 驾驶室门锁总成</p>	<p>YEM-H1325</p>  <p>ZAX240电喷 驾驶室门锁总成</p>	<p>YEM-H1326</p>  <p>E200B驾驶室门锁总成</p>	<p>YEM-H1327</p>  <p>E320/320B/320D 驾驶室门锁总成</p>
<p>YEM-H1328</p>  <p>E320C驾驶室门锁总成</p>	<p>YEM-H1329</p>  <p>SK-3驾驶室门锁总成 YN51C0109992</p>	<p>YEM-H1330</p>  <p>SK-5驾驶室门锁总成</p>	<p>YEM-H1331</p>  <p>SK200-6/8驾驶室门锁总成</p>
<p>YEM-H1332</p>  <p>SK超8驾驶室门锁总成</p>	<p>YEM-H1333</p>  <p>DH55驾驶室门锁总成</p>	<p>YEM-H1334</p>  <p>DH60-7门锁总成</p>	<p>YEM-H1335</p>  <p>DH220-5驾驶室门锁总成</p>

锁系列 LOCK

<p>YEM-H1336</p>  <p>Dx60门锁总成</p>	<p>YEM-H1337</p>  <p>DX200驾驶室门锁总成</p>	<p>YEM-H1338</p>  <p>R60-5驾驶室门锁总成</p>	<p>YEM-H1339</p>  <p>现代R60-7驾驶室门锁总成</p>	
<p>YEM-H1340</p>  <p>R-5驾驶室门锁总成</p>	<p>YEM-H1341</p>  <p>R-7驾驶室门锁总成</p>	<p>YEM-H1342</p>  <p>EC55驾驶室门锁总成</p>	<p>YEM-H1343</p>  <p>VOLVO驾驶室门锁总成</p>	
<p>YEM-H1344</p>  <p>EC480驾驶室门锁总成</p>	<p>YEM-H1345</p>  <p>HD700驾驶室门锁总成</p>	<p>YEM-H1346</p>  <p>HD820驾驶室门锁总成</p>	<p>YEM-H1347</p>  <p>HD820-3驾驶室门锁总成</p>	
<p>YEM-H1348</p>  <p>SH A1/A2驾驶室门锁总成</p>	<p>YEM-H1349</p>  <p>SH A3 驾驶室门锁总成</p>	<p>YEM-H1350</p>  <p>SHA5驾驶室门锁总成</p>	<p>YEM-H1351</p>  <p>徐工 柳工 力士德 驾驶室门锁总成</p>	
<p>YEM-H1352</p>  <p>三一(8) 驾驶室门锁总成</p>	<p>YEM-H1353</p>  <p>三一(9)驾驶室门锁总成</p>	<p>YEM-H1354</p>  <p>柳工驾驶室门锁总成</p>	<p>YEM-H1355</p>  <p>福田驾驶室门锁总成</p>	<p>YEM-H1356</p>  <p>PC56驾驶室门锁总成</p>























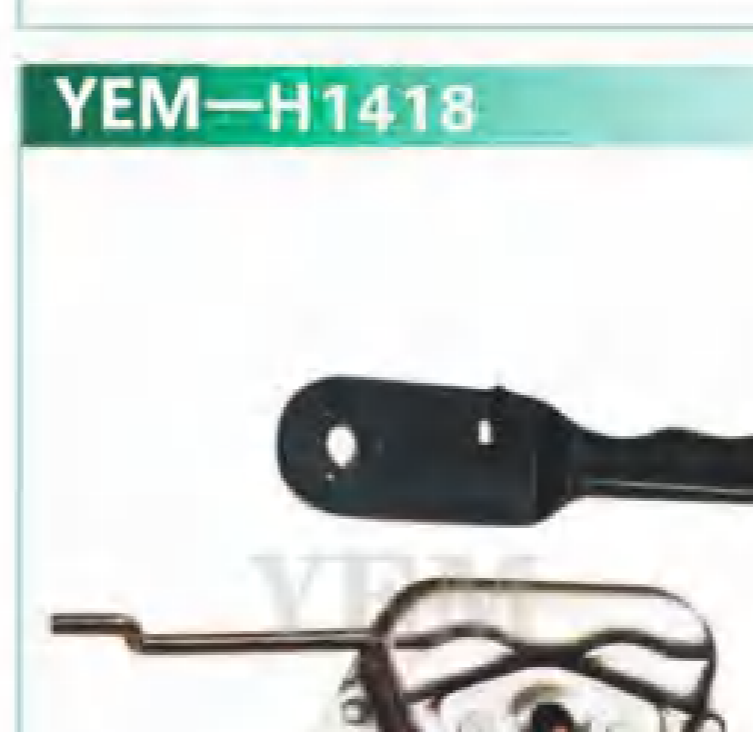

锁系列 LOCK

<p>YEM-H1357</p>  <p>卡特306, 307, 308门锁总成</p>	<p>YEM-H1358</p>  <p>柳工220-3众友913门锁总成</p>	<p>YEM-H1359</p>  <p>日立ZAX60, 70门锁总成带盖板</p>	<p>YEM-H1360</p>  <p>神钢60-8门锁总成</p>	
<p>YEM-H1361</p>  <p>神钢超8新款门锁总成</p>	<p>YEM-H1362</p>  <p>现代150-9门锁总成</p>	<p>YEM-H1363</p>  <p>现代225-9门锁总成</p>	<p>YEM-H1364</p>  <p>徐工60CA专用门锁总成</p>	
<p>YEM-H1365</p>  <p>徐工260新款门锁总成</p>	<p>YEM-H1366</p>  <p>玉柴35-6/60-6门锁总成</p>	<p>YEM-H1367</p>  <p>住友60专用门锁总成</p>	<p>YEM-H1368</p>  <p>住友A5驾驶室门锁总成</p>	
<p>YEM-H1369</p>  <p>福田85-65门锁总成</p>	<p>YEM-H1370</p>  <p>玉柴驾驶室门锁总成</p>	<p>YEM-H1371</p>  <p>神钢75-8后盖锁总成</p>	<p>YEM-H1372</p>  <p>柳工906老款后盖锁</p>	
<p>YEM-H1373</p>  <p>日立70后盖锁</p>	<p>YEM-H1374</p>  <p>卡特320CD后顶锁</p>	<p>YEM-H1375</p>  <p>卡特320后顶锁</p>	<p>YEM-H1376</p>  <p>CAT</p>	<p>YEM-H1377</p>  <p>ZAX200-6直喷工具箱锁</p>

锁系列 LOCK

<p>YEM-H1378</p>  <p>斗山DX260工具箱锁</p>	<p>YEM-H1379</p>  <p>现代-7新款工具箱锁</p>	<p>YEM-H1380</p>  <p>现代60-7工具箱锁</p>	<p>YEM-H1381</p>  <p>卡特320D2工具箱锁</p>	<p>YEM-H1382</p>  <p>ZAX 工具箱锁 LOCK</p>
<p>YEM-H1383</p>  <p>E320C 工具箱锁 LOCK</p>	<p>YEM-H1384</p>  <p>E320D 工具箱锁 LOCK</p>	<p>YEM-H1385</p>  <p>住友210A5工具箱锁</p>	<p>YEM-H1386</p>  <p>现代60-7专用反扣锁</p>	<p>YEM-H1387</p>  <p>小松-8临工反扣锁</p>
<p>YEM-H1388</p>  <p>沃尔沃480D反扣锁</p>	<p>YEM-H1389</p>  <p>柳工卡特320C国产机大挖反扣锁</p>	<p>YEM-H1390</p>  <p>加藤820反扣锁</p>	<p>YEM-H1391</p>  <p>国产小挖反扣锁</p>	<p>YEM-H1392</p>  <p>斗山-5/7/9反扣锁总成</p>
<p>YEM-H1393</p>  <p>ZAX电喷反扣锁</p>	<p>YEM-H1394</p>  <p>ZAX450-6反扣锁</p>	<p>YEM-H1395</p>  <p>ZAX200-6直喷反扣锁</p>	<p>YEM-H1396</p>  <p>PC/EX/DH/HD/R/SK/SH 20Y-54-36380反扣锁</p>	<p>YEM-H1397</p>  <p>ZAX反扣锁盖</p>
<p>YEM-H1398</p>  <p>CAT反扣锁盖</p>	<p>YEM-H1399</p>  <p>Ex70反扣锁</p>	<p>YEM-H1400</p>  <p>ZAX反扣锁</p>	<p>YEM-H1401</p>  <p>EX-5反扣锁</p>	<p>YEM-H1402</p>  <p>VOLVO反扣锁</p>

锁系列 LOCK

<p>YEM-H1403</p>  <p>小挖反扣锁</p>	<p>YEM-H1404</p>  <p>柳工反扣锁</p>	<p>YEM-H1405</p>  <p>反扣锁U型卡</p>	<p>YEM-H1406</p>  <p>加藤820-3下档插销</p>	<p>YEM-H1407</p>  <p>小松78US通用门锁外拉</p>
<p>YEM-H1408</p>  <p>小松-8天窗锁</p>	<p>YEM-H1409</p>  <p>ZAX电喷先导锁杆</p>	<p>YEM-H1410</p>  <p>斗山后顶锁</p>	<p>YEM-H1411</p>  <p>沃尔沃480D门锁锁块</p>	<p>YEM-H1412</p>  <p>现代-9天窗扣</p>
<p>YEM-H1413</p>  <p>EX200-1外拉手</p>	<p>YEM-H1414</p>  <p>R60-5后备锁</p>	<p>YEM-H1415</p>  <p>DH55后备锁</p>	<p>YEM-H1416</p>  <p>PC60-7后备锁</p>	<p>YEM-H1417</p>  <p>PC300后备锁</p>
<p>YEM-H1418</p>  <p>住友200A3前档锁</p>	<p>YEM-H1419</p>  <p>小松三一小挖前档锁</p>	<p>YEM-H1420</p>  <p>玉柴85-8前档锁</p>	<p>YEM-H1421</p>  <p>小松-7前档锁</p>	<p>YEM-H1422</p>  <p>神钢超8前档锁</p>
<p>YEM-H1423</p>  <p>神钢-8前档锁</p>	<p>YEM-H1424</p>  <p>日立6070前档锁</p>	<p>YEM-H1425</p>  <p>ZAX电喷前档锁</p>	<p>YEM-H1426</p>  <p>日立70前档锁扣</p>	<p>YEM-H1427</p>  <p>卡特320CD前档锁</p>

锁系列 LOCK

<p>YEM-H1428</p>  <p>斗山-7前档锁原装款</p>	<p>YEM-H1429</p>  <p>小松200和300机罩锁U型扣</p>	<p>YEM-H1430</p>  <p>小松300-6/7机罩锁</p>	<p>YEM-H1431</p>  <p>小松200-6/7/8机罩锁</p>	<p>YEM-H1432</p>  <p>小松6型(下档肖)玻璃插肖</p>
<p>YEM-H1433</p>  <p>日立5型(下档肖)玻璃插肖</p>	<p>YEM-H1434</p>  <p>DH/SK 下档肖</p>	<p>YEM-H1435</p>  <p>DH55 下档肖</p>	<p>YEM-H1436</p>  <p>通用长钩(锌合金)玻璃扣 Lock</p>	<p>YEM-H1437</p>  <p>通用玻璃扣 Lock</p>
<p>YEM-H1438</p>  <p>孔 5.0 国产机玻璃扣 Lock</p>	<p>YEM-H1439</p>  <p>卡特 孔 5.5 玻璃扣 Lock</p>	<p>YEM-H1440</p>  <p>驾驶室门合叶</p>	<p>YEM-H1441</p>  <p>边门合叶</p>	<p>YEM-H1442</p>  <p>PC-5下档栓 国产机</p>
<p>YEM-H1443</p>  <p>1.5牙x10厘 1.5牙x10厘 1.25牙x8厘 1.5牙x10厘 1.75牙x12厘 各类机型门顶胶</p>	<p>YEM-H1444</p>  <p>PC EX CAT SK SH HD DH R 边门锁芯</p>			
<p>YEM-H1445</p>  <p>EX 驾驶室锁芯 ZAX 驾驶室锁芯</p>	<p>YEM-H1446</p>  <p>SH 驾驶室锁芯 SK 驾驶室锁芯</p>	<p>YEM-H1447</p>  <p>DH 驾驶室锁芯 PC 驾驶室锁芯</p>	<p>YEM-H1448</p>  <p>PC200-7门窗锁</p>	

油箱传感器 FUEL TANK SENSOR

<p>YEM-H1449</p>  <p>油箱传感器 Fuel Tank Sensor PC200-6/7 7861-92-6810/5810</p>	<p>YEM-H1450</p>  <p>油箱传感器 Fuel Tank Sensor PC200-5 7861-92-4800</p>	<p>YEM-H1451</p>  <p>油箱传感器 Fuel Tank Sensor PC300-8</p>	<p>YEM-H1452</p>  <p>油箱传感器 Fuel Tank Sensor EX200-1/2 4257128</p>
<p>YEM-H1453</p>  <p>油箱传感器 Fuel Tank Sensor E320C/D 238-2227/163-6700</p>	<p>YEM-H1454</p>  <p>油箱传感器 Fuel Tank Sensor CAT320 105-9993X</p>	<p>YEM-H1455</p>  <p>油箱传感器 Fuel Tank Sensor CAT 320B</p>	
<p>YEM-H1456</p>  <p>油箱传感器 Fuel Tank Sensor KATO 加藤</p>	<p>YEM-H1457</p>  <p>油箱传感器 Fuel Tank Sensor KOBELCO 神钢</p>	<p>YEM-H1458</p>  <p>油箱传感器 FUEL TANK SENSOR DH220-5 DOOSAN</p>	
<p>YEM-H1459</p>  <p>油箱传感器 Fuel Tank Sensor SH A3</p>	<p>YEM-H1460</p>  <p>DH 5孔 DH 6孔</p>	<p>YEM-H1461</p>  <p>油箱传感器 FUEL TANK SENSOR SK-8</p>	
<p>YEM-H1462</p>  <p>叉车油箱浮子</p>	<p>YEM-H1463</p>  <p>柳工908C 油箱浮子</p>	<p>YEM-H1464</p>  <p>柳工 中大挖 油箱浮子</p>	
<p>YEM-H1465</p>  <p>油箱传感器 Fuel Tank Sensor VOLVO55</p>	<p>YEM-H1466</p>  <p>油箱传感器 Fuel Tank Sensor VOLVO480D</p>	<p>YEM-H1467</p>  <p>油箱传感器 Fuel Tank Sensor VOLVO210/290</p>	
<p>YEM-H1468</p>  <p>油箱传感器 Fuel Tank Sensor 现代 (66CM)</p>	<p>YEM-H1469</p>  <p>油箱传感器 Fuel Tank Sensor 现代 (73CM)</p>	<p>YEM-H1470</p>  <p>油箱传感器 Fuel Tank Sensor 现代 (81CM)</p>	

油尺 HYDRAULIC OIL DIPSTICK

YEM-H1471

320B/C/D 53.5长
E200B 320 36长
回转泵油尺

YEM-H1472

SK 47.5长
SH DH
4BD1
回转泵油尺

YEM-H1473

ZAX200 31.2长
日立200-5 21长
回转泵油尺

YEM-H1474

PC200-8回转油尺
PC200-7回转油尺 60长
回转油尺

YEM-H1475

现代回转油尺
ZAX240-3电喷 54.5长
回转油尺

YEM-H1476

小松200-5/6回转油尺 短31.5长
小松120-5/6回转油尺 44长
回转油尺

YEM-H1477

6HK1机油尺 114长
6D105机油尺 83长

YEM-H1478

6D102机油尺 112.5长
6D125机油尺 105长

YEM-H1479

31长 4TNV94 机油尺
35长 4D84

YEM-H1480

6BD1机油尺 78长
6D95机油尺 75长

YEM-H1481

J05/J08机油尺 98长
S6K机油尺 64长

YEM-H1482

4JB1机油尺
6HK1机油尺

YEM-H1483

C9 EOM:208-7474机油尺
6D34机油尺 EOM:441312

YEM-H1484

D6D机油尺 EOM:1182018
6D102机油尺套管

YEM-H1485

EX200-1 回转油尺 38.5长
EX120-5 回转油尺 25长

YEM-H1486

DH放油阀
VOLVO

YEM-H1487

铝壳油尺

YEM-H1488

VOLVO360
VOLVO290
订做加长油尺
HYDRAULIC OIL DIPSTICK

油尺 HYDRAULIC OIL DIPSTICK

YEM-H1489

PC 泵油尺 好

YEM-H1490

HD 泵油尺 好

YEM-H1491

EX 好

YEM-H1492

CAT 好 铝头

YEM-H1493

SK 好 铝头

YEM-H1494

DH 好 铝头

YEM-H1495

R 好 铝头

YEM-H1496

PC
HD

YEM-H1497

EX200泵油尺 普

YEM-H1498

CAT

YEM-H1499

SK

YEM-H1500

DH

YEM-H1501

R

YEM-H1502

EX120 泵油尺

YEM-H1503

订做油尺

YEM-H1504

EX 泵油尺

YEM-H1505

CAT 泵油尺

YEM-H1506

SK 泵油尺

YEM-H1507

DH 泵油尺

YEM-H1508

SH 泵油尺

YEM-H1509

R 泵油尺

YEM-H1510



S6K E200B E320B/C

YEM-H1511

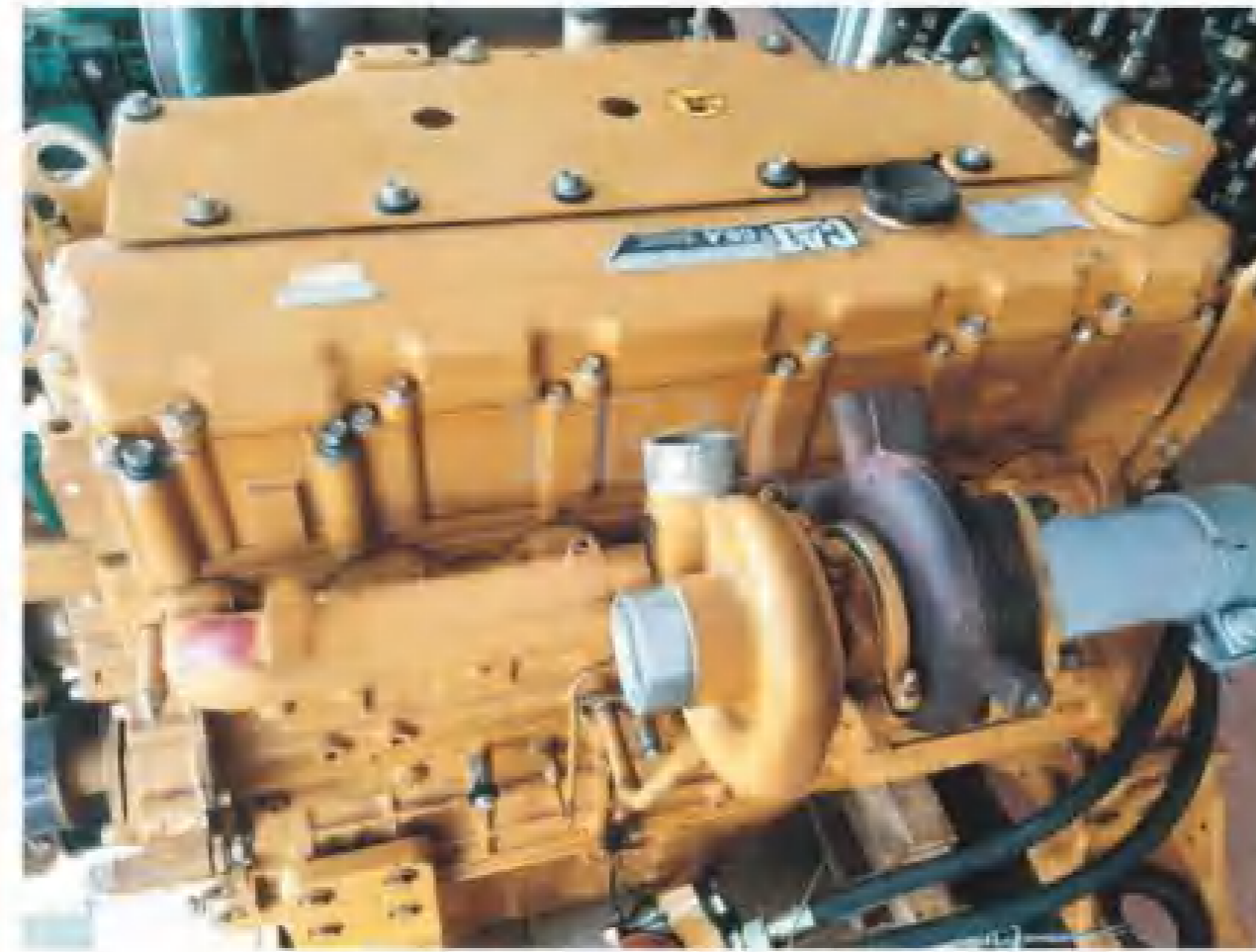

E320D

YEM-H1512



YANMAR 4TNV94

YEM-H1520



PC360-7 6CT
单节温器 3939313

YEM-H1521



PC360-7 6CT
双节温器 C3971411

YEM-H1522



S6D95/S6D95L
PC200-5
OEM: 6209-21-1200
OEM: 6207-21-1102

YEM-H1513



YANMAR 4TNV98

YEM-H1514



HINO J05E

YEM-H1515



KUBOTA V3800

YEM-H1523

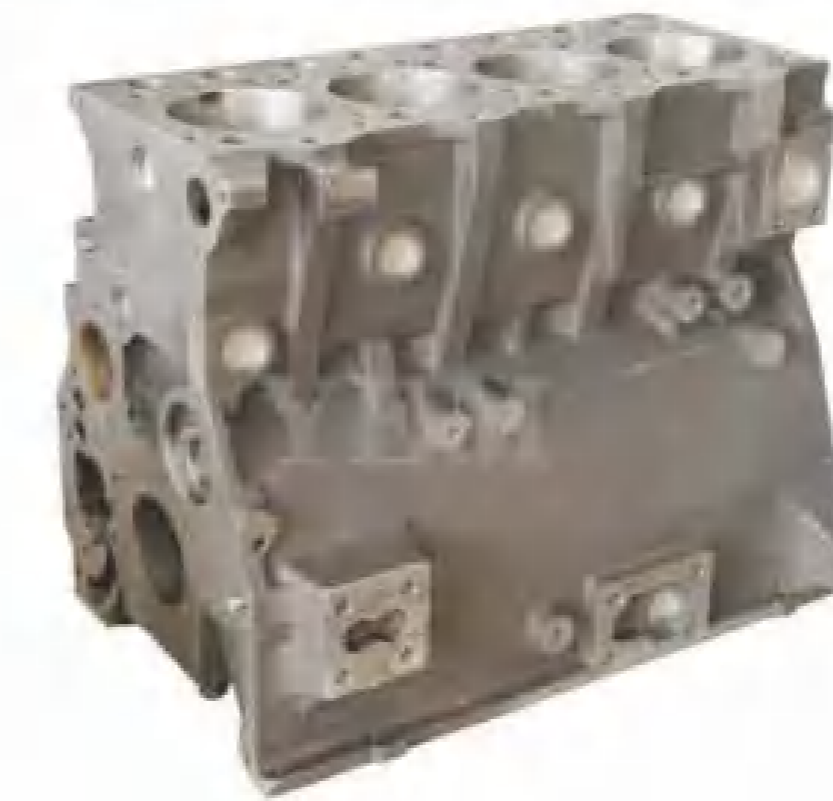

4D95
OEM: 6204-21-1102

YEM-H1524



4BD1 4BG1
OEM: 8-97130328-4
OEM: 8-97123954-2

YEM-H1525

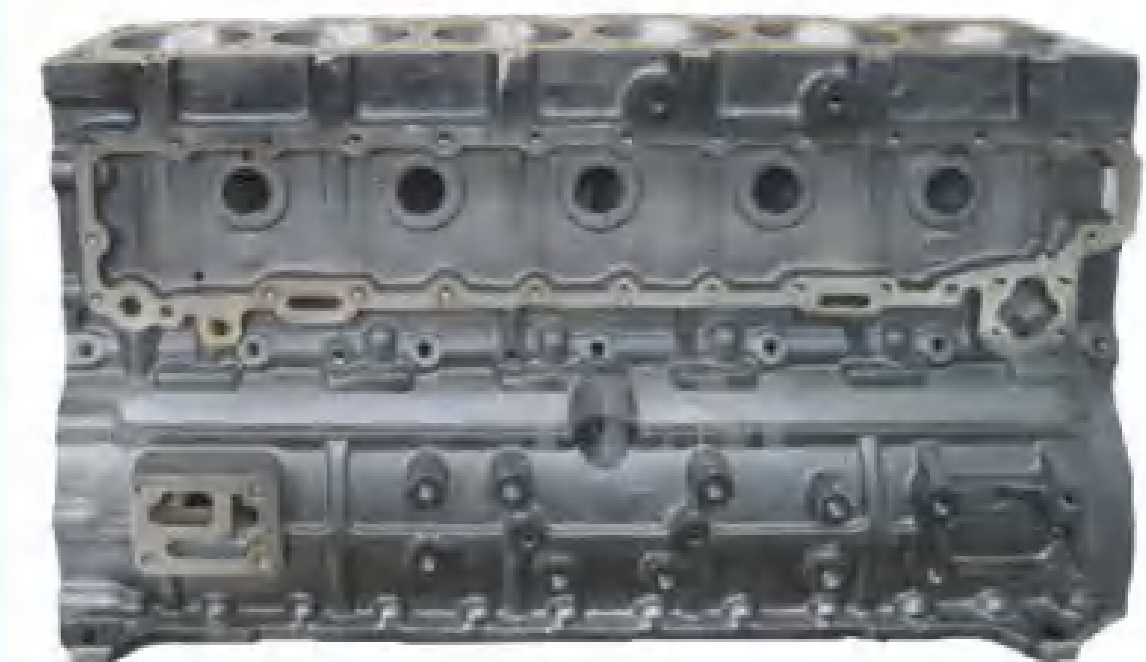

6BD1T
OEM: 1-11210442-3

YEM-H1516



洋马4TNV98油壳

YEM-H1517



B3.3飞轮壳

YEM-H1518



6D107飞轮壳
PC200-8

YEM-H1519



6D114飞轮壳

YEM-H1529

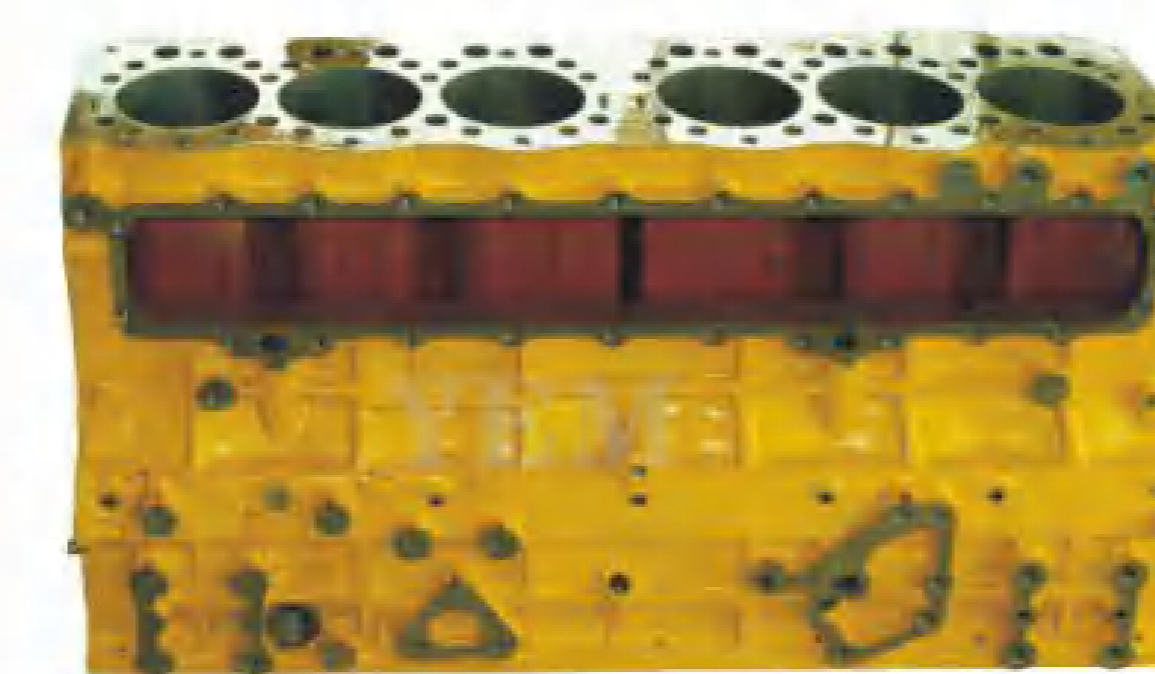

CAT 3066
CAT E200B 320 320B 320C 7JK
OEM: 5I-7530 125-2964 178 -6593

YEM-H1530



CAT 3306
OEM: 1N3576

YEM-H1531



7N5454
CAT 3304

缸体 CYLINDER BLOCK

缸盖 CYLINDER HEAD

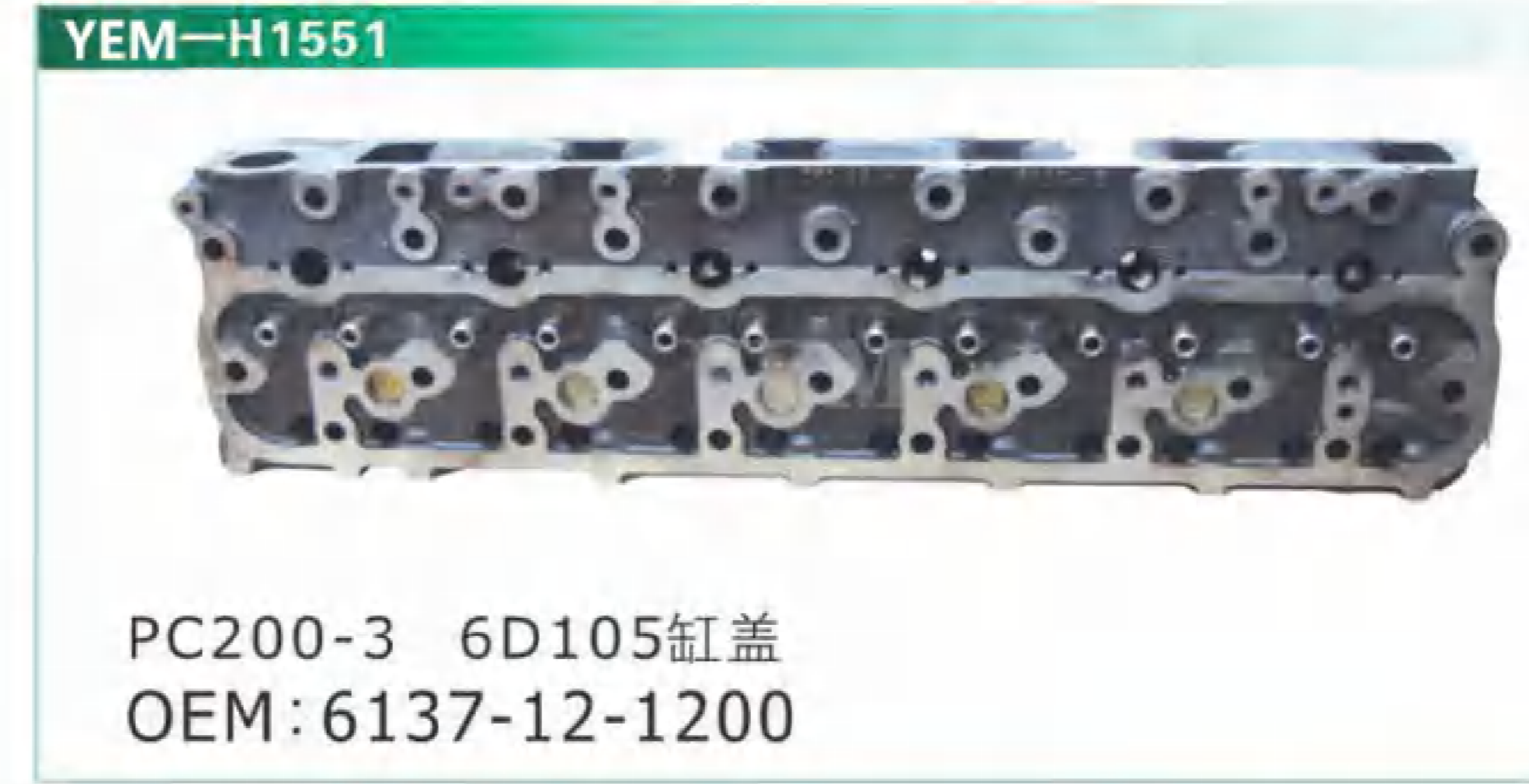
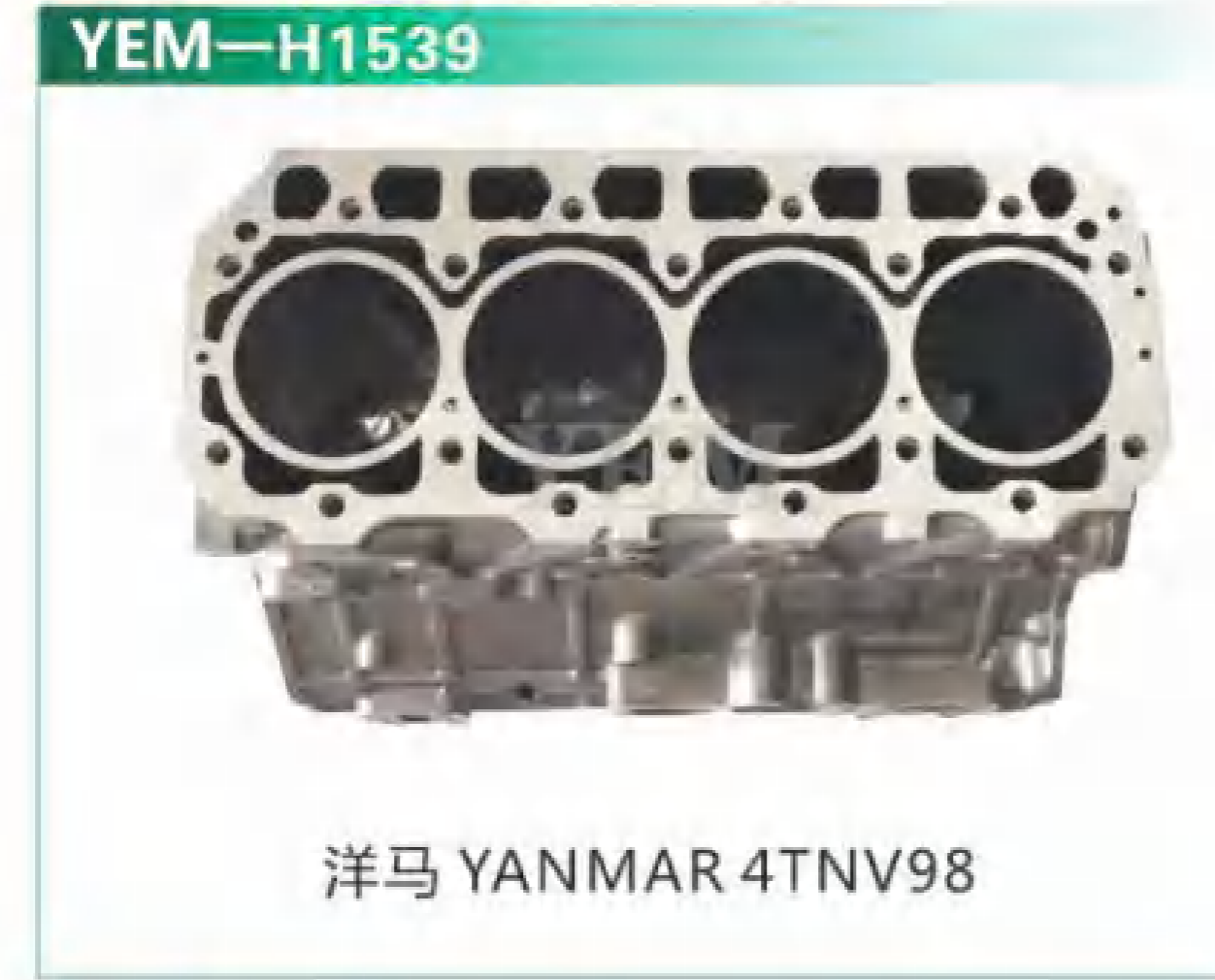
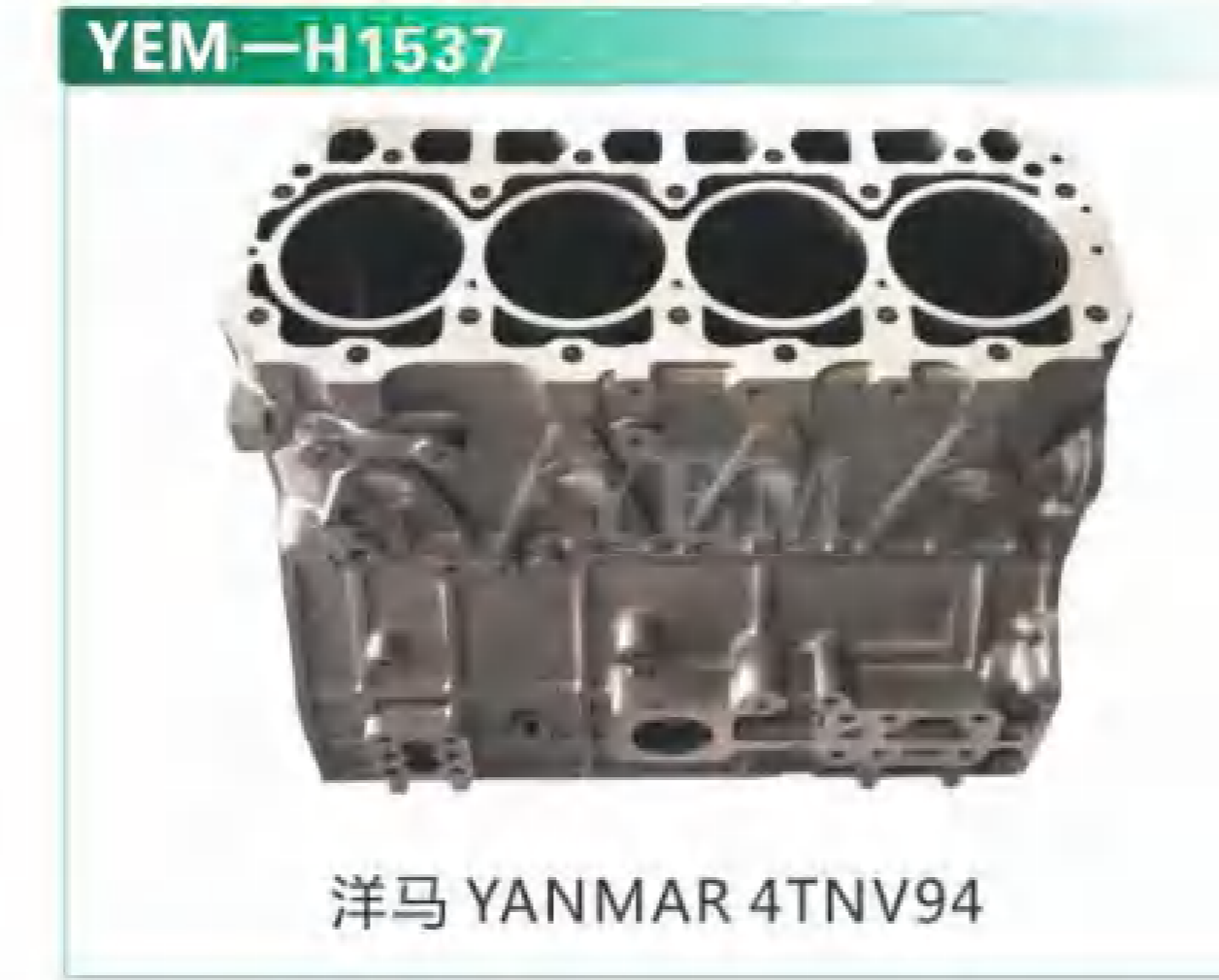

缸盖 CYLINDER HEAD

YEM-H1557

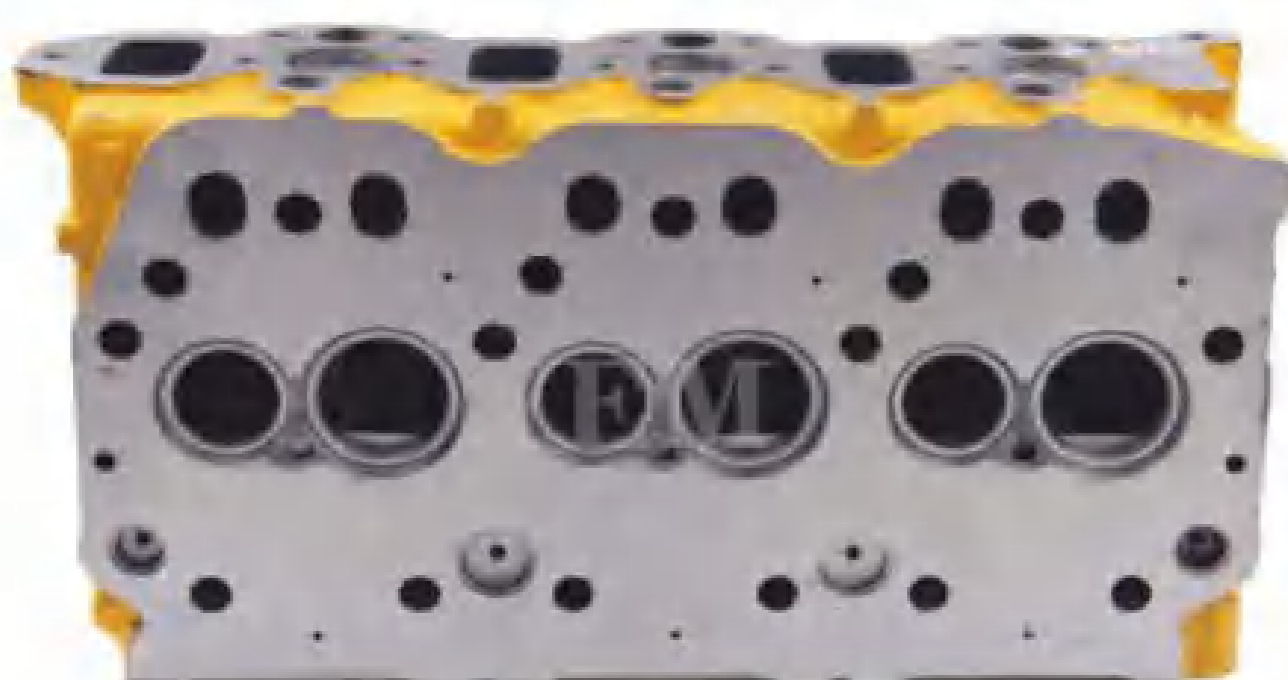

320C前 OEM:34301-04060

YEM-H1558

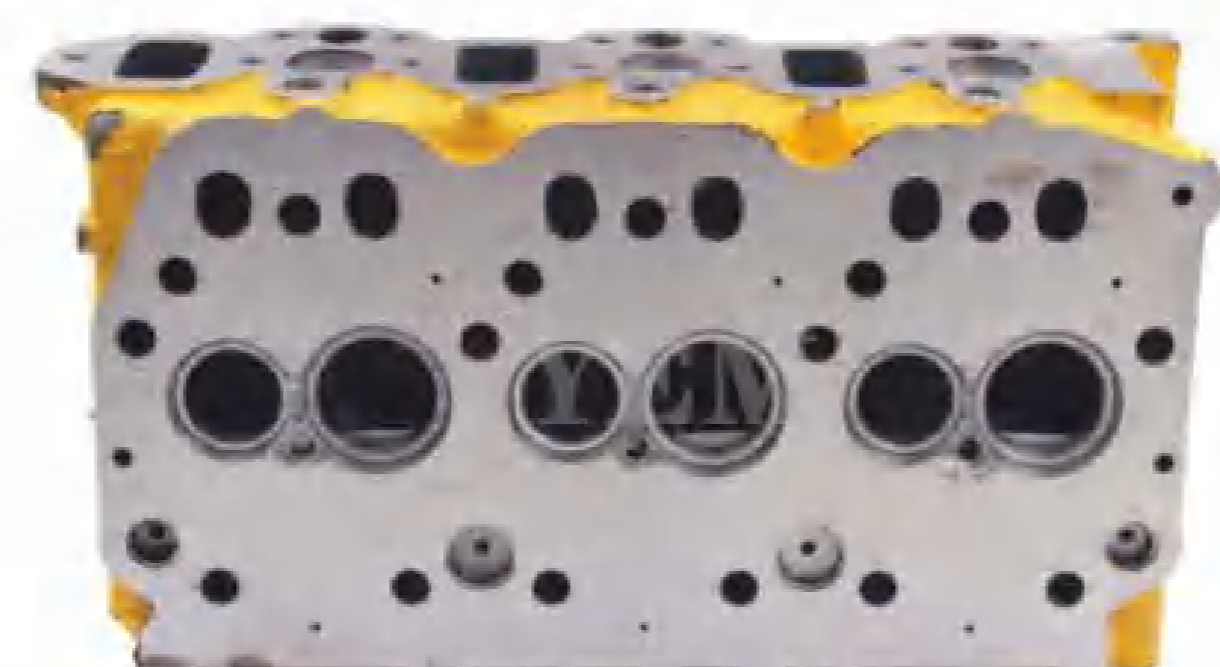

320C后 OEM:34301-04050

YEM-H1559

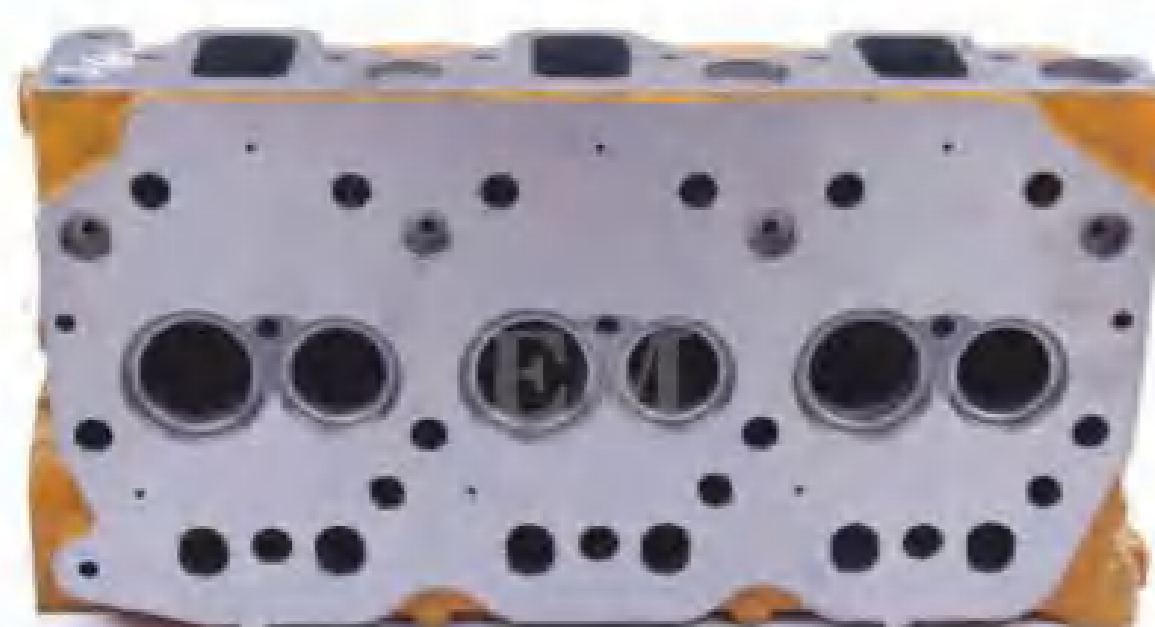

S6K后 OEM:518051
OEM:34301-01060

YEM-H1560



S6K前 OEM:518052
OEM:34301-01050

YEM-H1561



CAT 3304缸盖
OEM:1N.4304

YEM-H1562



卡特3204 3208缸盖
OEM:2W7165/612378

YEM-H1563



DH220-3 D1146T
OEM:65.03101-6087C

YEM-H1564



CAT3304缸盖
OEM:8N1188

YEM-H1565



4M40缸盖 CAT307 CAT308 OEM:ME193805

YEM-H1566



B3.3 不带预热塞不带增压
CAT3306 缸盖 OEM:8N6796直喷 8N1187 易燃

缸盖 CYLINDER HEAD

YEM-H1567



6D114 6CT8.3缸盖
OEM:3991155

YEM-H1568



OEM:DB58 DH220-5缸盖
1-11110600-3

YEM-H1569

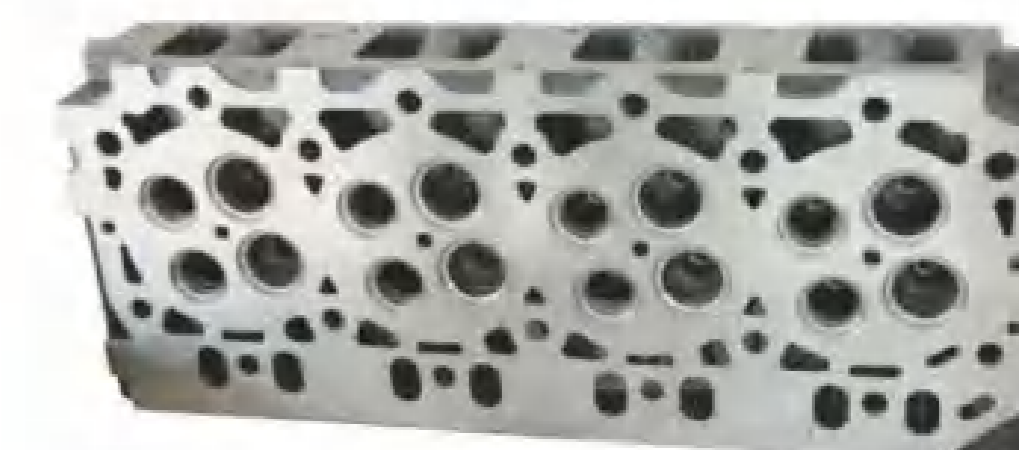

4TNV94/4TNV98 缸盖

YEM-H1570



DA640缸盖

YEM-H1571



6HK1 电喷 8-98180566-0

YEM-H1572



6HK1 直喷 8-94392451-0

YEM-H1573



PC300-8 OEM: 4942139

YEM-H1574

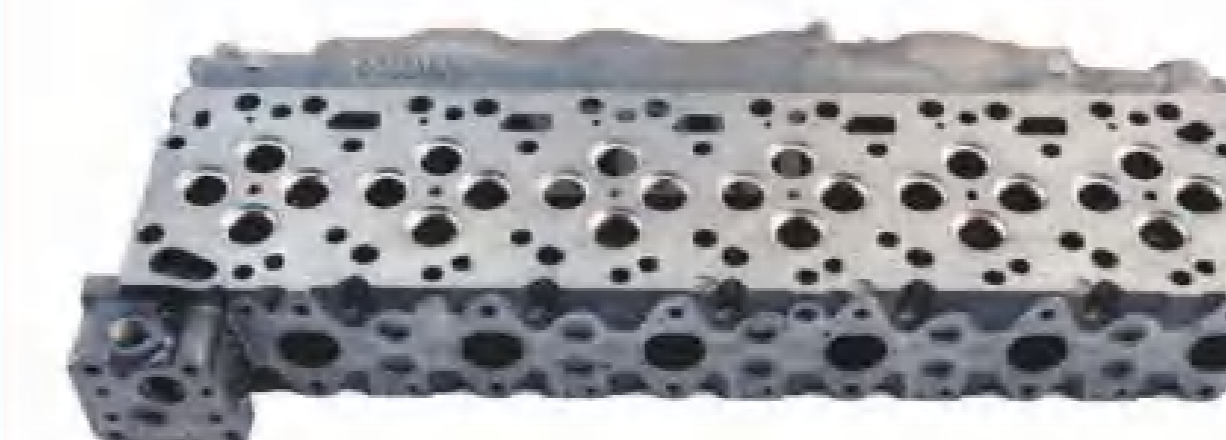

6D107 OEM: 397725

YEM-H1575



6SD1

YEM-H1576

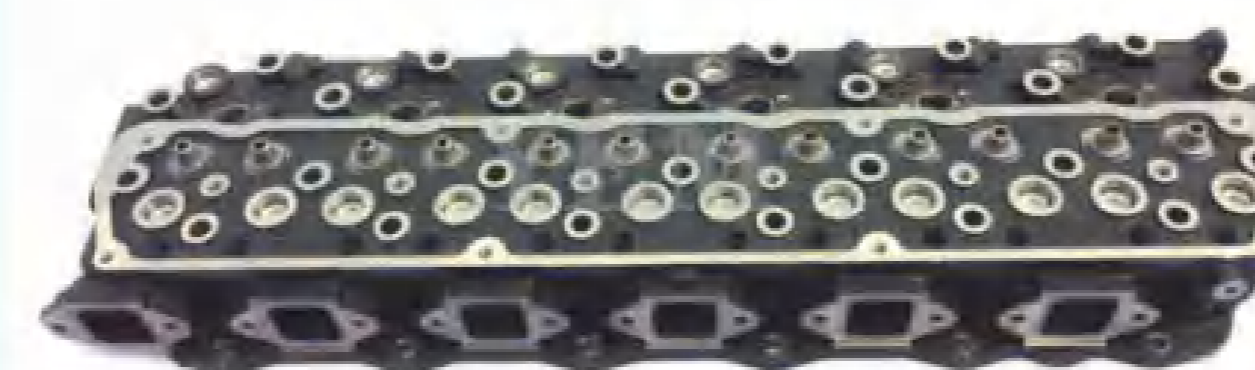

6D16 SK

YEM-H1577

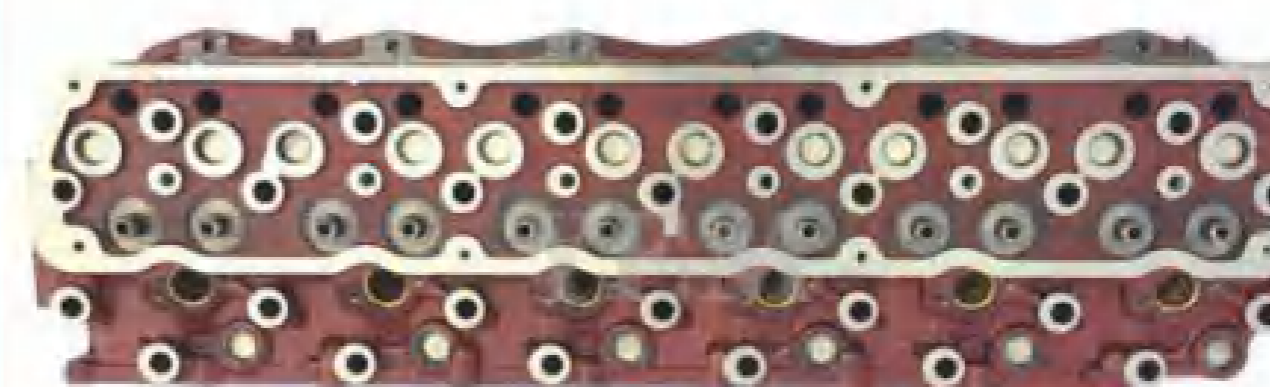

6D16 R

YEM-H1578



J05E

YEM-H1579



4HK1 OEM: 8-9800836-3

YEM-H1580



4JG2

YEM-H1581



B3.3 不带预热塞不带增压

缸盖 CYLINDER HEAD

曲轴 CRANKSHAFT

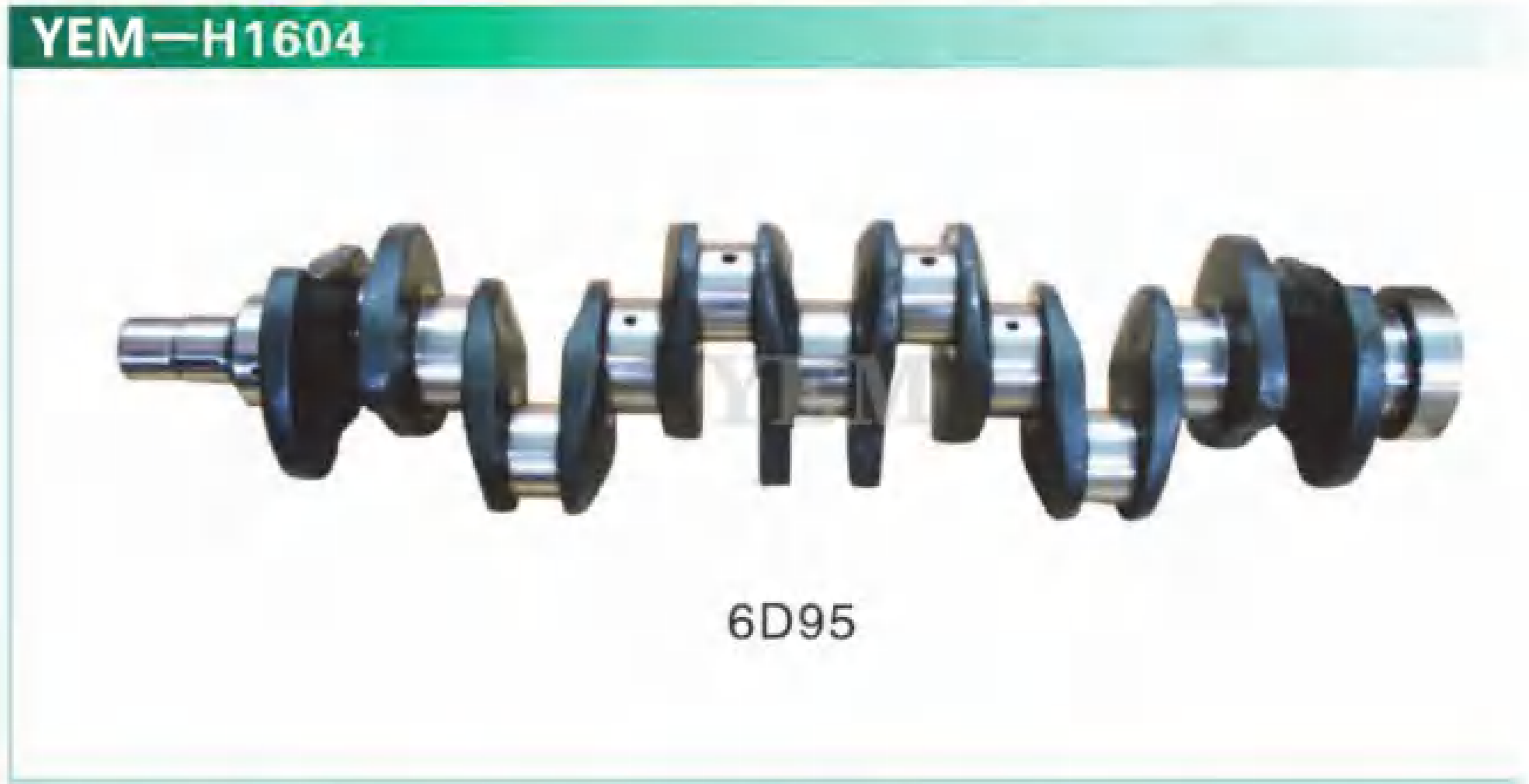
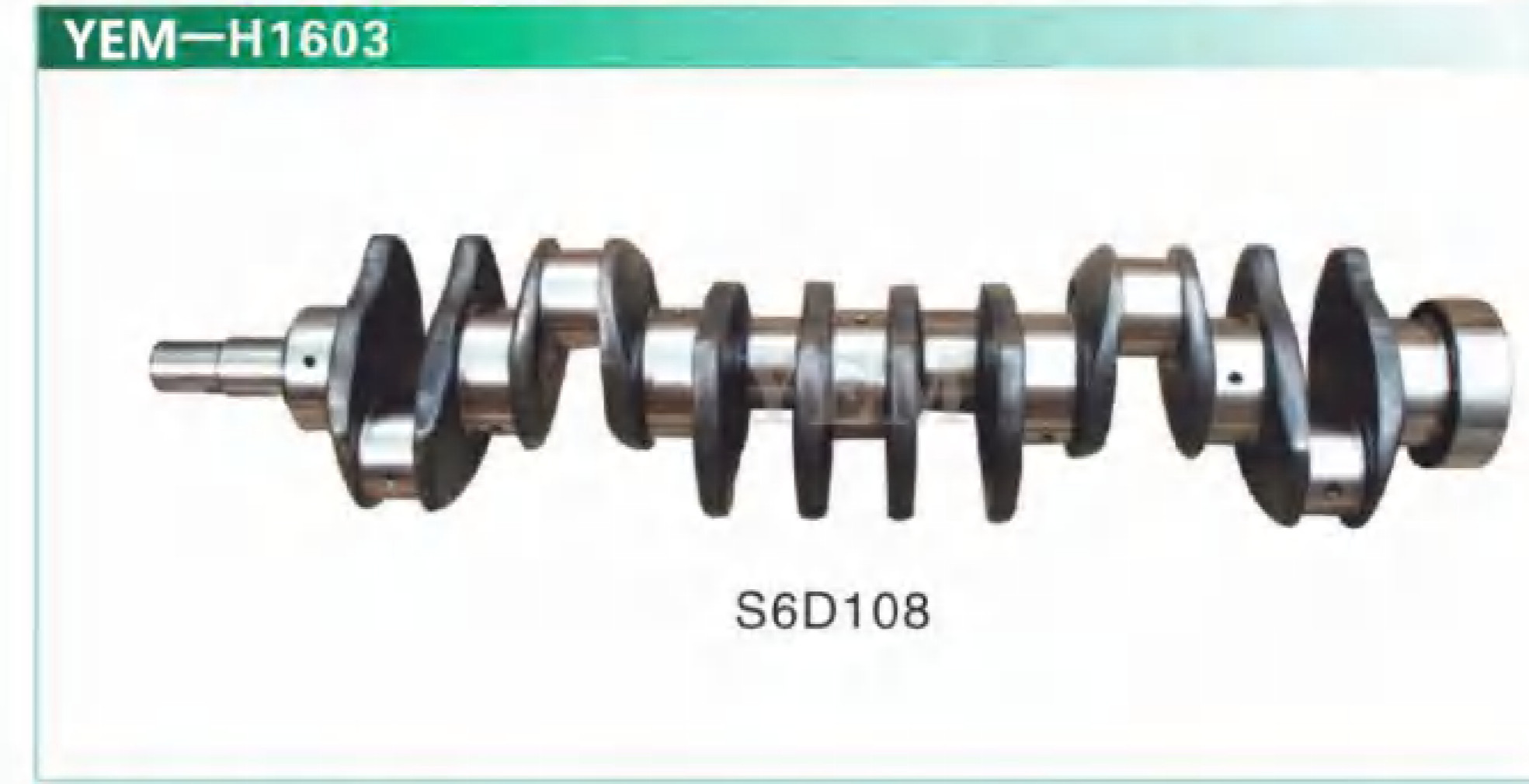
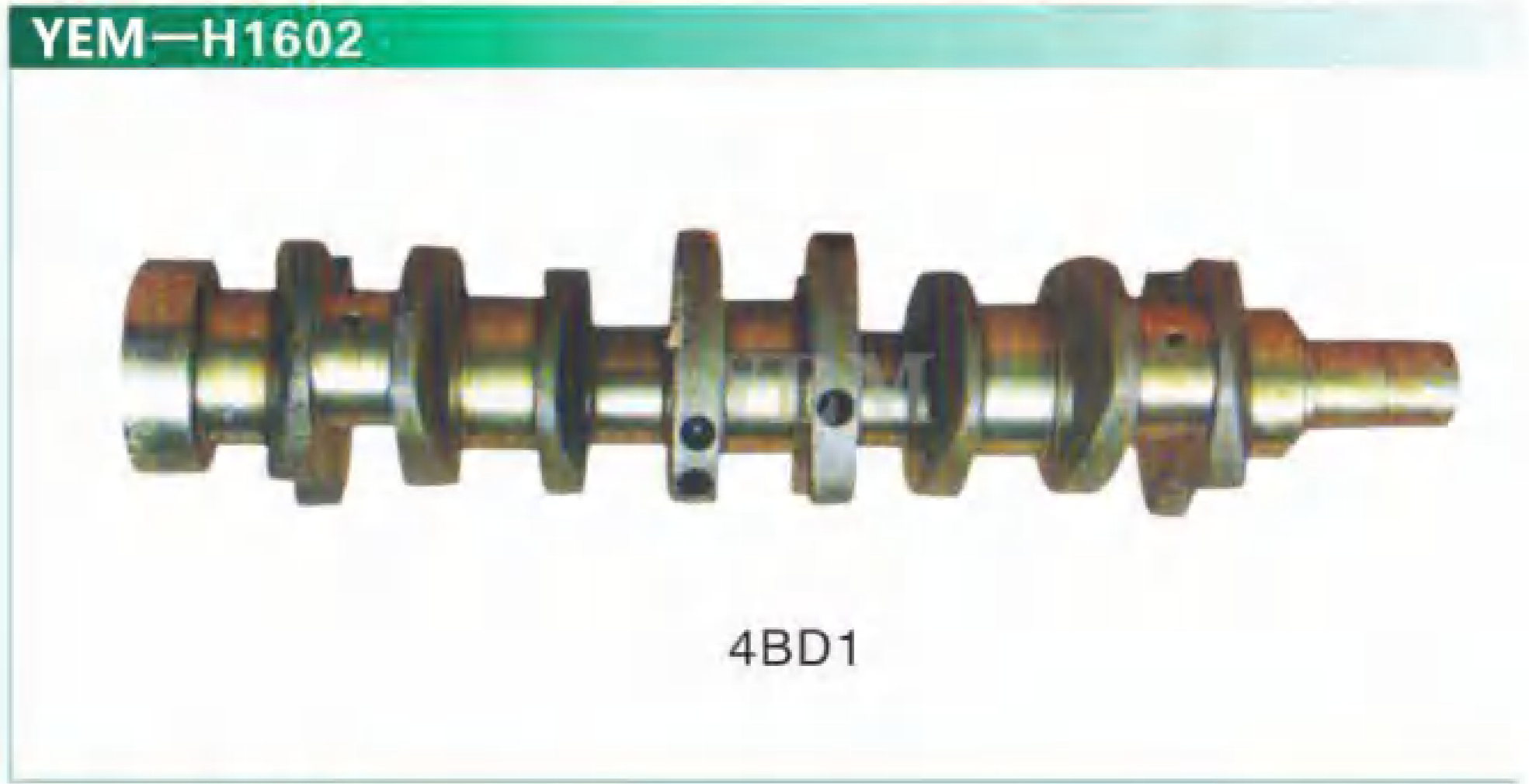
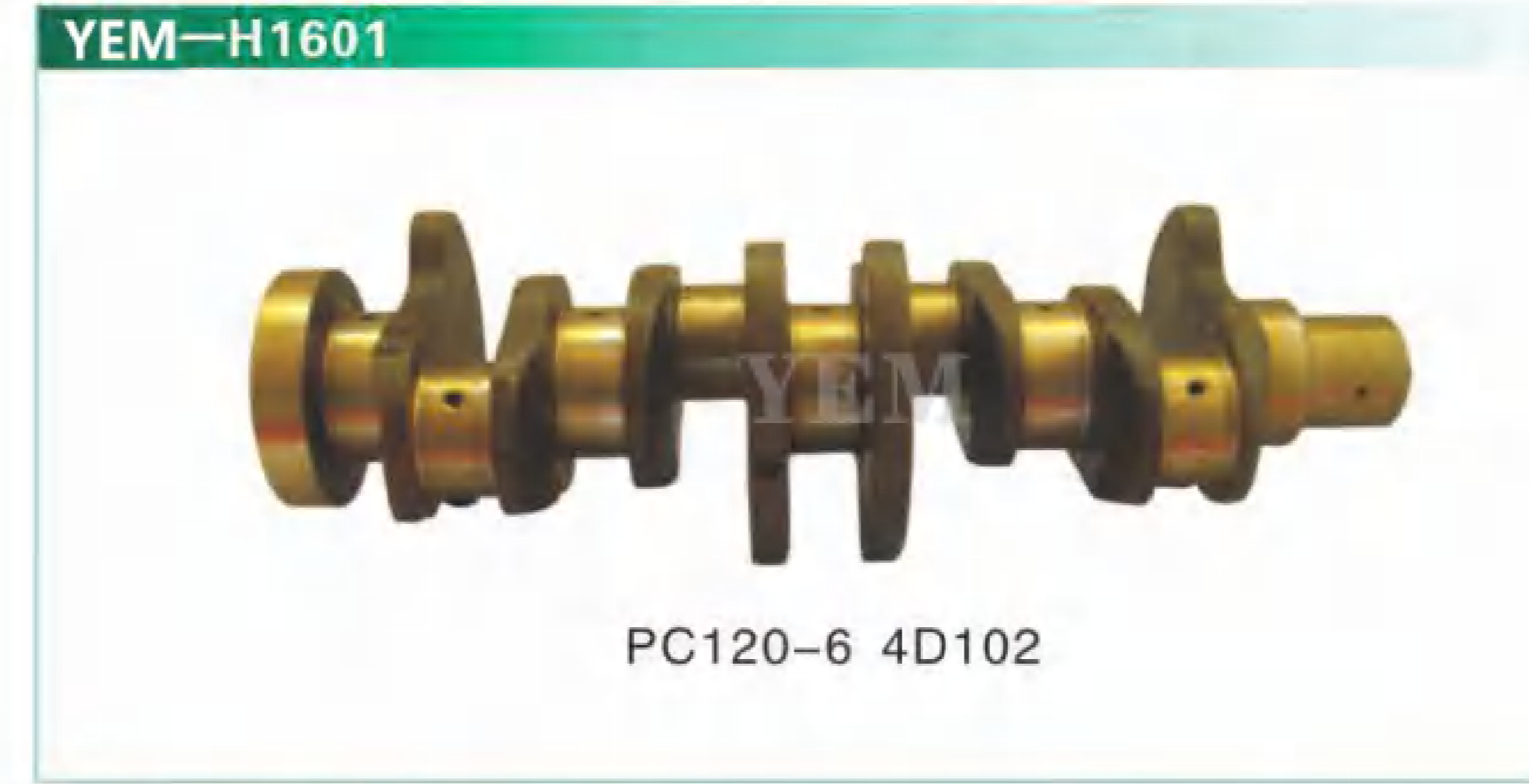
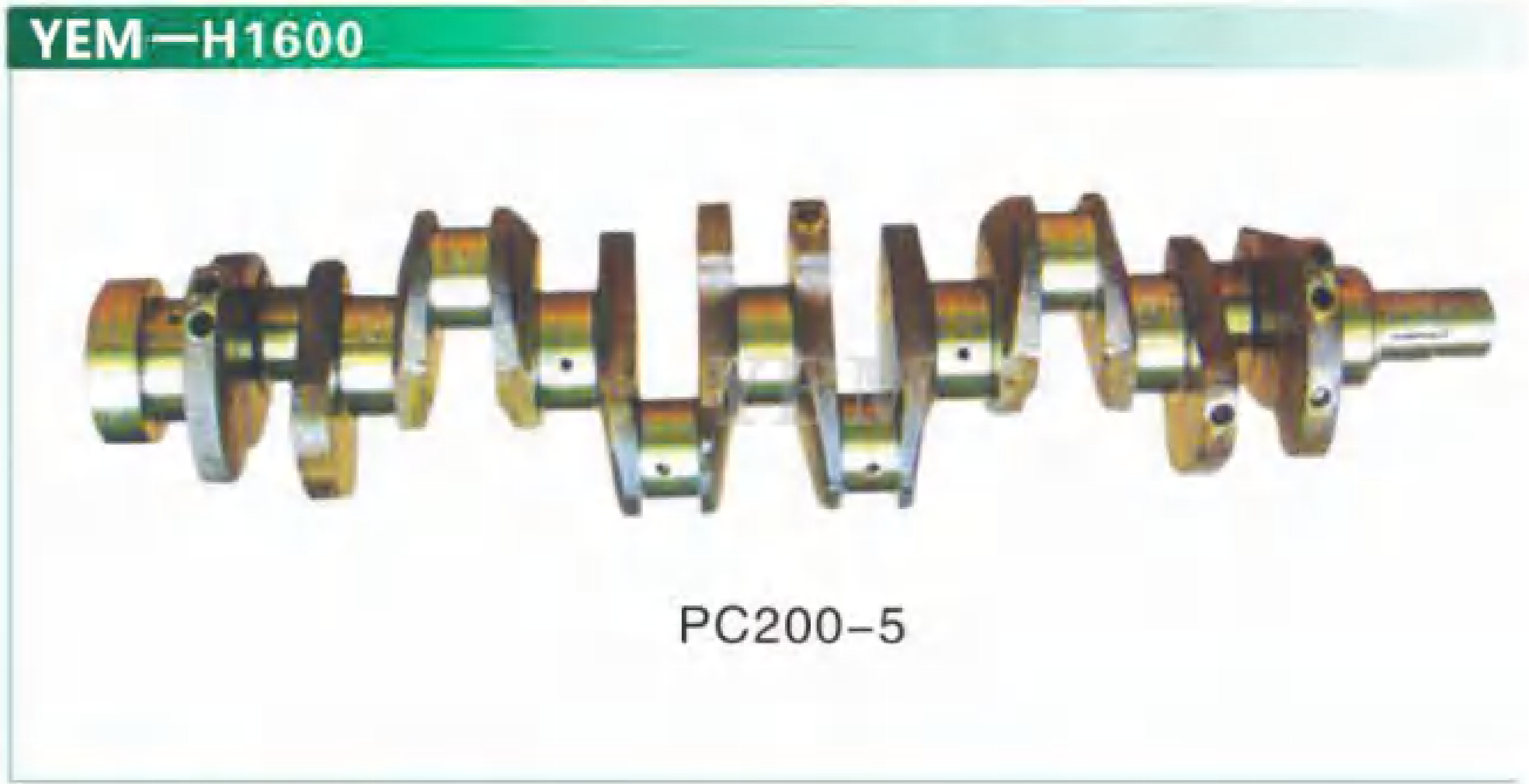
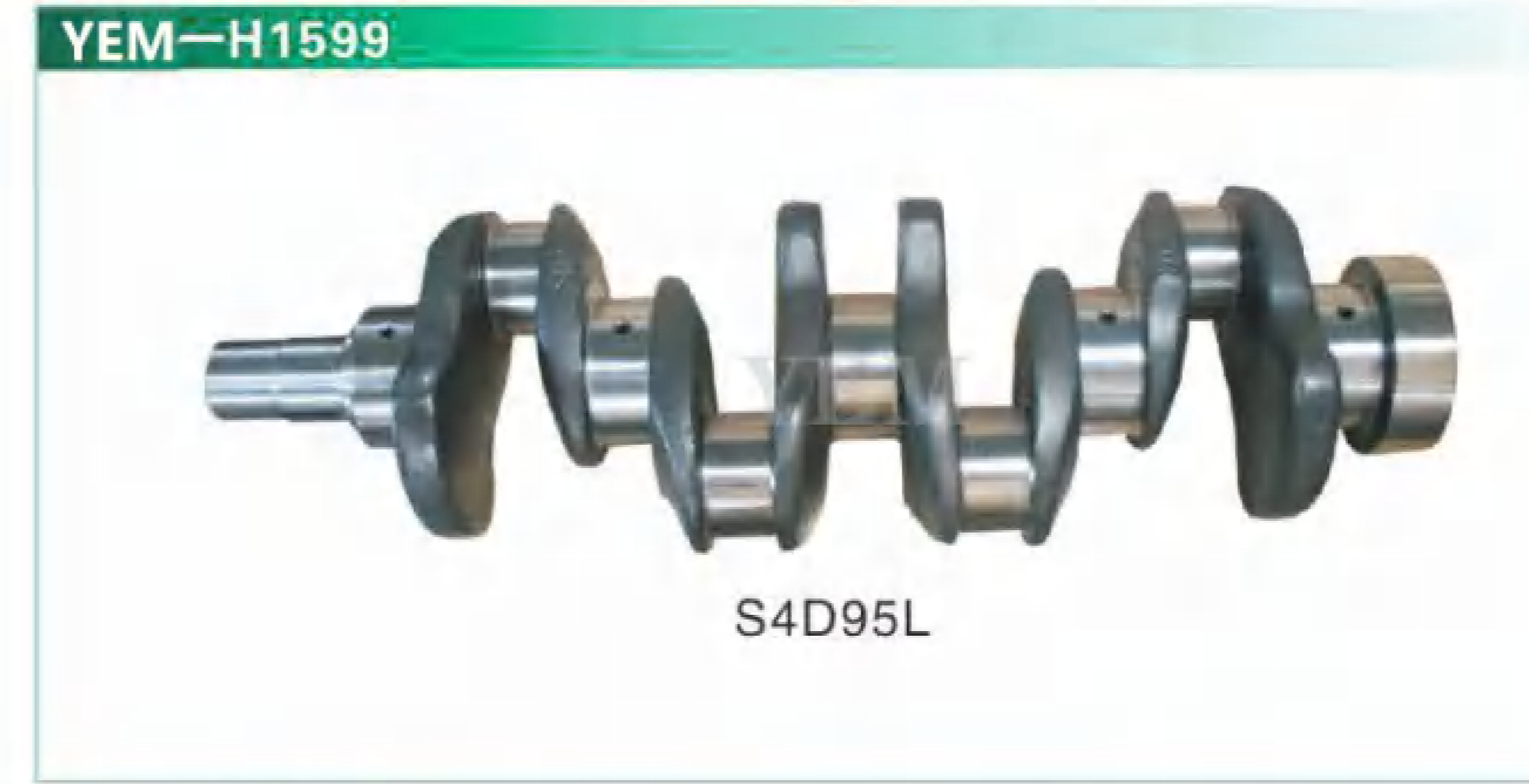
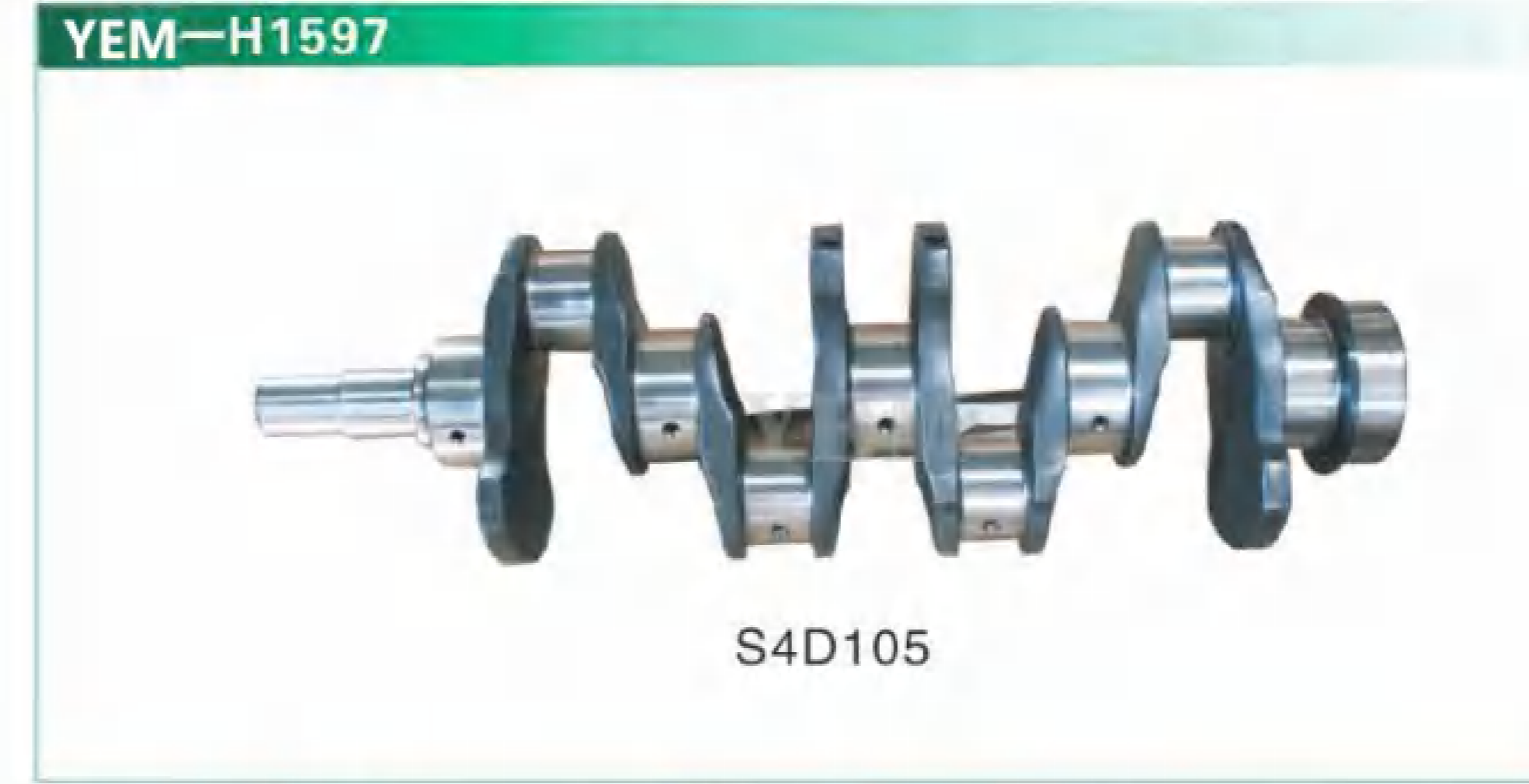
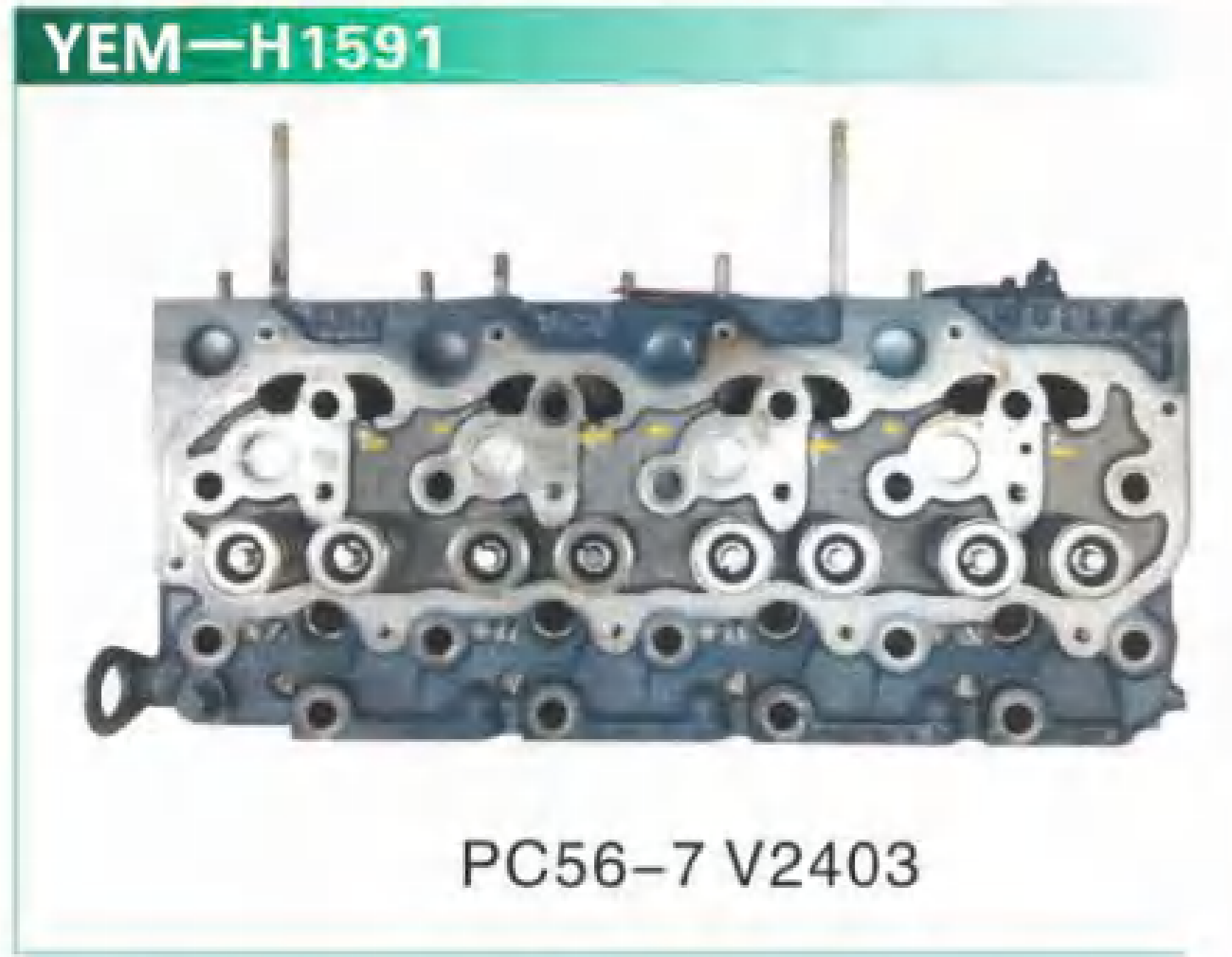

曲轴 CRANKSHAFT

YEM-H1607



4BG1

YEM-H1609



6D22

YEM-H1611



B3.3

YEM-H1613



EX200-1/2 6BD1T 1123104071

YEM-H1615



4HK1

YEM-H1617



4D31

YEM-H1608



6D15T

YEM-H1610



S6K

YEM-H1612



6CT

YEM-H1614



E3306 2W7458

YEM-H1616



S4K

YEM-H1618



4JB1

曲轴 CRANKSHAFT

YEM-H1619



6BD1T

YEM-H1621



KUBOTA V2403

YEM-H1623

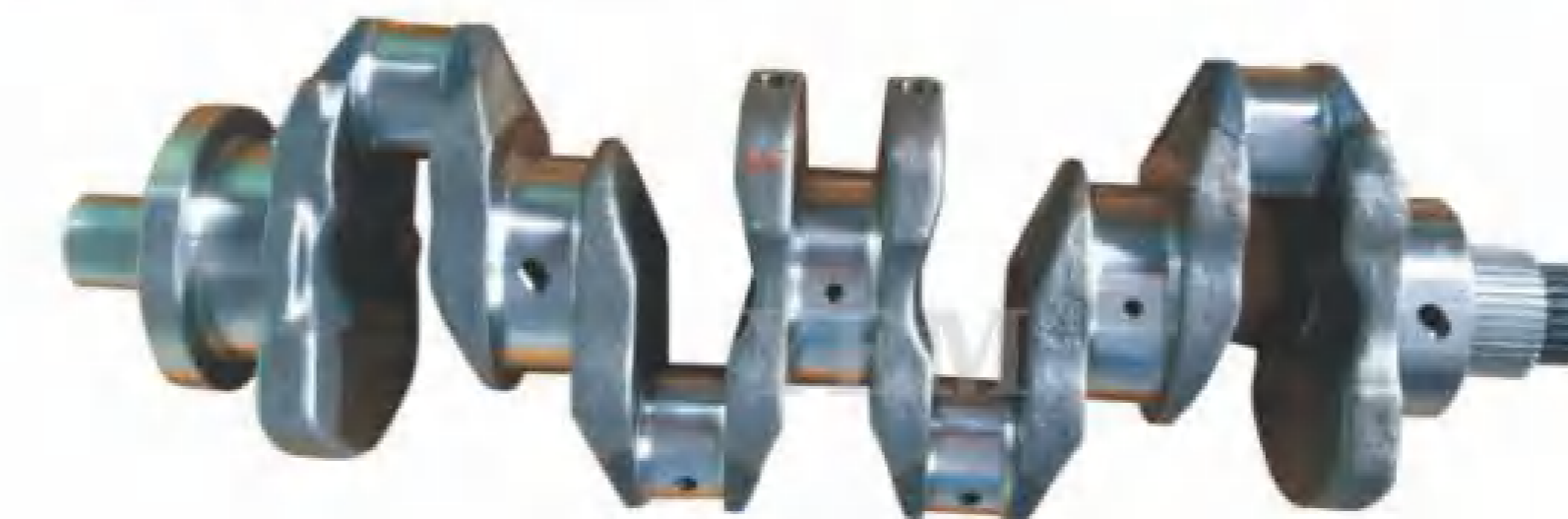

KUOTA V3307

YEM-H1625



4TNE84

YEM-H1627



4TNV88

YEM-H1629



NT855

YEM-H1620



S4F

YEM-H1622



KUOTA V3800

YEM-H1624



A2300

YEM-H1626



4TNE94

YEM-H1628



3D84-2

YEM-H1630



6D155

曲轴 CRANKSHAFT

YEM-H1631



6HK1

YEM-H1633



4TNV94

YEM-H1635



6D102

YEM-H1637



6D110

YEM-H1639



6D15

YEM-H1641



4BG1

YEM-H1632



4D88

YEM-H1634



PD6

YEM-H1636



6D125

YEM-H1638



6SD1

YEM-H1640



6D105

YEM-H1642



6D14T

曲轴 CRANKSHAFT

YEM-H1643



4JB1

YEM-H1645



6BG1

YEM-H1647



S6D108

YEM-H1649



4TNV94

YEM-H1651



4D95

YEM-H1653



6D125

YEM-H1644



S4K

YEM-H1646



4D31

YEM-H1648

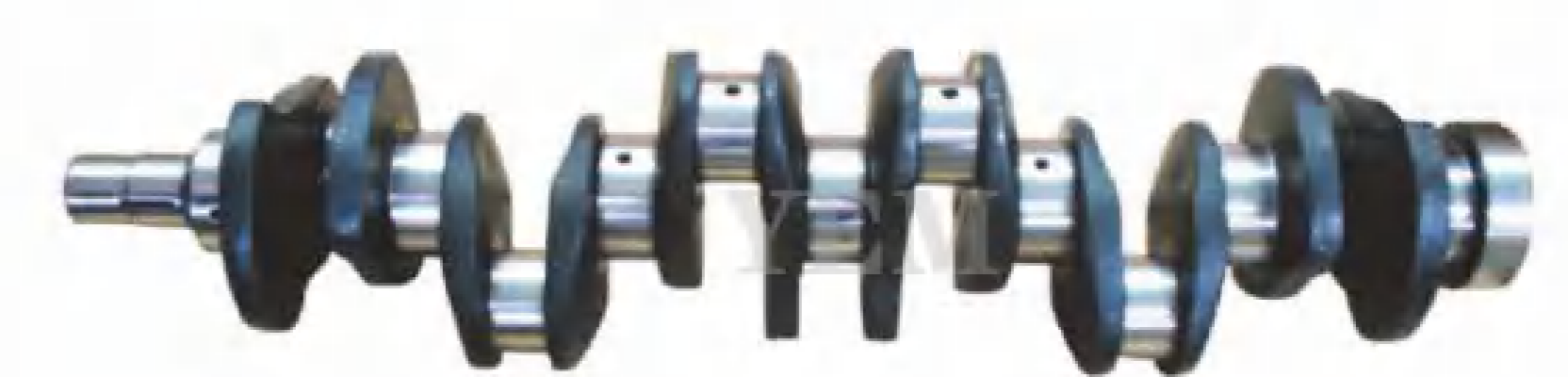

6D95

YEM-H1650



6D107

YEM-H1652



S6K

YEM-H1654



6D34

凸轮轴 CAMSHAFT

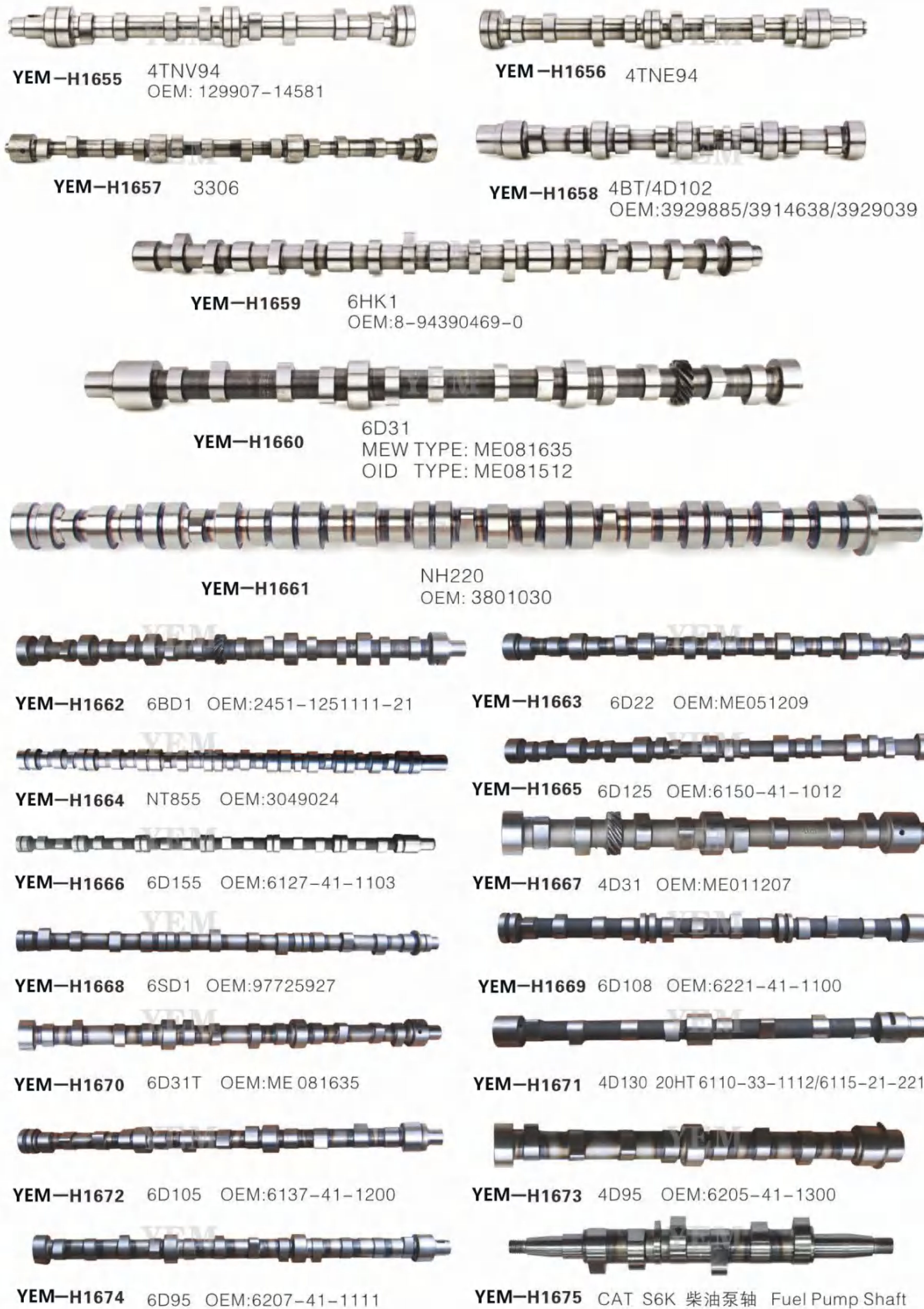

凸轮轴 CAMSHAFT

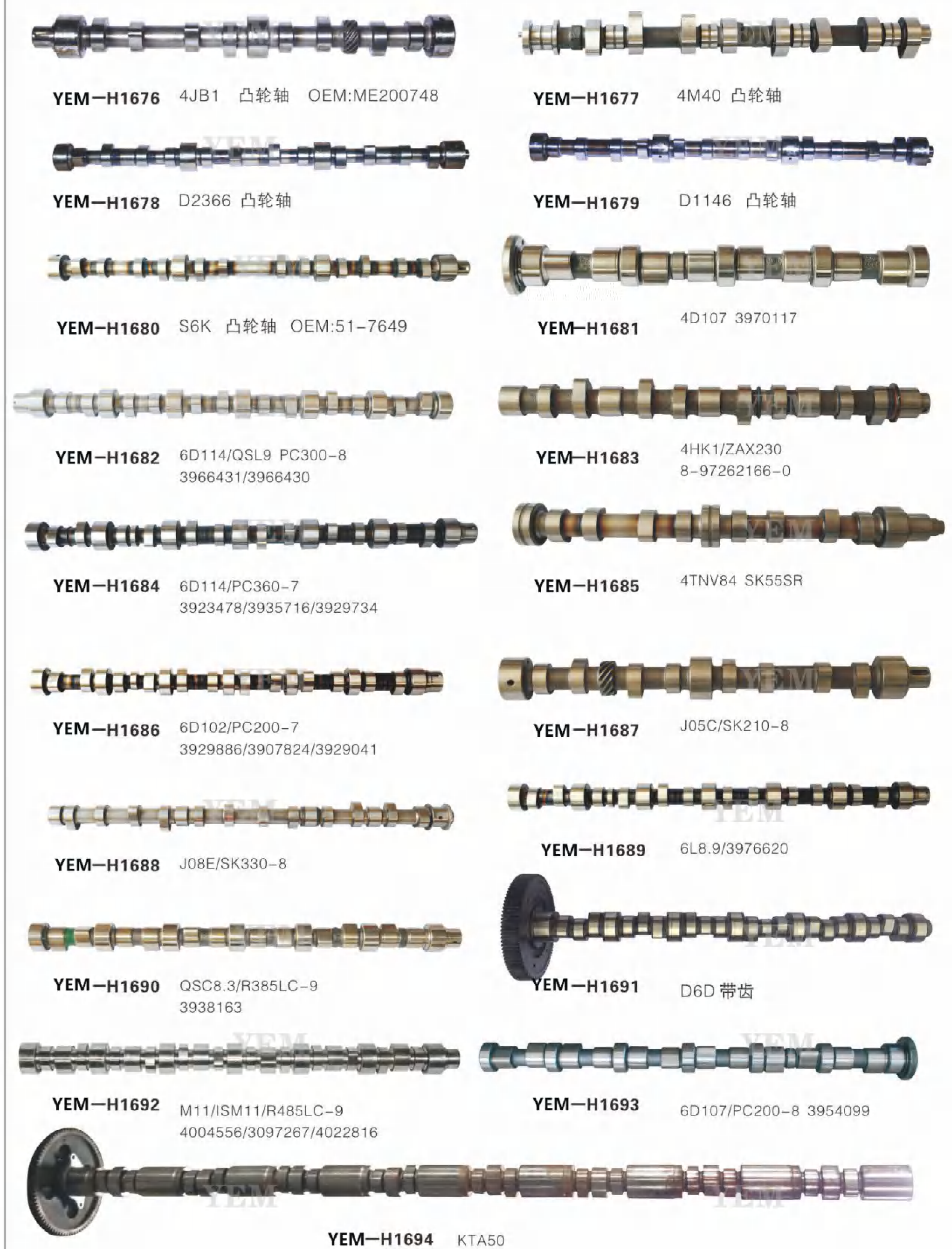

连杆 CON-ROD

连杆 CON-ROD

YEM-H1695



6BD1

YEM-H1696



S6K
OEM:34319-01010

YEM-H1697



6D31

YEM-H1710



DH280-3

YEM-H1711



6SD1
OEM:1-122 30097-0

YEM-H1712



NH220
OEM:6620-31-3012

YEM-H1698



6D125
OEM:6150-31-3100

YEM-H1699



6D95
OEM:6206-31-3101

YEM-H1700



PC130-7

YEM-H1713



NT855
OEM:6710-21-2210

YEM-H1714



6D22 8B1720

YEM-H1715



8N1727 CAT3306

YEM-H1701



4TNV94

YEM-H1702



6BG1

YEM-H1703



4TNV88

YEM-H1716



PD6

YEM-H1717



3306

YEM-H1718



6D14平口Straight

YEM-H1704



6CT 6D114 OEM: 3801383

YEM-H1705



6D102 3942581

YEM-H1706



6D34 OEM:240966

YEM-H1719



6D14斜口Tappter

YEM-H1720



6D102
OEM:3942581

YEM-H1721



6D108
OEM:6221-31-3130

YEM-H1707



6HK1 OEM: 8-98064281-0

YEM-H1708



D7E

YEM-H1709



J05E OEM: 13260-10100

YEM-H1722



4D95
OEM:6204-31-3101

YEM-H1723



6D108
OEM:6136-32-3101

YEM-H1724



6D25
OEM:6150-31-3100

YEM-H1725



卡特缸套组件系列
CAT LINER KIT SERIES

S6K	LINER KIT	缸套组件
3066	LINER KIT	缸套组件
3204	LINER KIT	缸套组件
3306/8N3182	LINER KIT	缸套组件
3306/8N3102	LINER KIT	缸套组件
3306/1W6757	LINER KIT	缸套组件
3406/9Y7212	LINER KIT	缸套组件
3408/9Y4004	LINER KIT	缸套组件
	LINER KIT	缸套组件



YEM-H1726



康明斯缸套组件系列
CUMMINS LINER KIT SERIES

4BT	LINER KIT	缸套组件
6BT/3926631	LINER KIT	缸套组件
6DTAA/3907163	LINER KIT	缸套组件
NH220/6620-31-2110	LINER KIT	缸套组件
NT855/3048808	LINER KIT	缸套组件
5CT/3917707	LINER KIT	缸套组件
K19/3096680	LINER KIT	缸套组件
LT10	LINER KIT	缸套组件
M11/3080760	LINER KIT	缸套组件



YEM-H1729



三菱缸套组件系列
MTSUBISHI LINER KIT SERIES

4/6D31	6D22	LINER KIT	缸套组件
4/6D34	8DC2	LINER KIT	缸套组件
S6K	8DC8	LINER KIT	缸套组件
6D14/T	8DC91	LINER KIT	缸套组件
6D15/T	S4S	LINER KIT	缸套组件
6D16/T	S4F	LINER KIT	缸套组件
6D20	4M40	LINER KIT	缸套组件



YEM-H1730



日野缸套组件系列
HINO LINER KIT SERIES

H06C	HMDKT3301
H07C	HMDKT4301
EH700	04013-1140A
EK100	04013-1096A
EP100	
EL100	
EF750	04013-1112A



YEM-H1727



小松缸套组件系列
KOMATSU LINER KIT SERIES

4D92	6D125	LINER KIT	缸套组件
4D94	6D140	LINER KIT	缸套组件
4/6D95	6D155	LINER KIT	缸套组件
4/6D102	6D170	LINER KIT	缸套组件
4/6D105	4D120	LINER KIT	缸套组件
6D108	4D130	LINER KIT	缸套组件
6D110		LINER KIT	缸套组件



YEM-H1728



洋马缸套组件系列
YANMAR LINER KIT SERIES

3TNV84	LINER KIT	缸套组件
3TNE84	LINER KIT	缸套组件
4TNV94	LINER KIT	缸套组件
4TNE94	LINER KIT	缸套组件
4TNV98	LINER KIT	缸套组件
4TNE98	LINER KIT	缸套组件
4TNV88	LINER KIT	缸套组件



YEM-H1731



五十铃缸套组件系列
ISUZU LINER KIT SERIES

4BD1	4LE1	LINER KIT	缸套组件
4BG1	4LE2	LINER KIT	缸套组件
6BD1	6RB1	LINER KIT	缸套组件
6BG1	4JB1	LINER KIT	缸套组件
6SD1	4HK1	LINER KIT	缸套组件
6WG1	6HK1	LINER KIT	缸套组件



YEM-H1732



























斗山缸套组件系列
DOOSAN LINER KIT SERIES

























DH220-3	FD6	LINER KIT	缸套组件
DH220-5	FE6	LINER KIT	缸套组件
H06C	PD6	LINER KIT	缸套组件
H07C	PE6	LINER KIT	缸套组件
EH700	RD8	LINER KIT	缸套组件
EK100	RE8	LINER KIT	缸套组件
EM100	RF8	LINER KIT	缸套组件
EL100	FD6T	LINER KIT	缸套组件
EF550	FE6T	LINER KIT	缸套组件
EF750	PD6T	LINER KIT	缸套组件
F17C	PE6T	LINER KIT	缸套组件



活塞系列 PISTON SERIES

<p>YEM-H1733</p>  <p>MITSUBISHI 6D22</p>	<p>YEM-H1734</p>  <p>MITSUBISHI 6D34 Me014160</p>	<p>YEM-H1735</p>  <p>MITSUBISHI 6DB10</p>	<p>YEM-H1736</p>  <p>MITSUBISHI 6D15-2AT ME072055</p>	<p>YEM-H1737</p>  <p>MITSUBISHI 4M40 ME200680</p>
<p>YEM-H1738</p>  <p>MITSUBISHI 6D14-2AT ME072047</p>	<p>YEM-H1739</p>  <p>MITSUBISHI 6D15-3AT ME072321</p>	<p>YEM-H1740</p>  <p>MITSUBISHI 6D16T ME078502</p>	<p>YEM-H1741</p>  <p>MITSUBISHI 6D16T ME072065</p>	<p>YEM-H1742</p>  <p>MITSUBISHI 6DB1 30017-90100</p>
<p>YEM-H1743</p>  <p>MITSUBISHI 6D22T ME052792</p>	<p>YEM-H1744</p>  <p>MITSUBISHI 6D34T ME014160</p>	<p>YEM-H1745</p>  <p>ISUZU 6BG1T 1-12111-7810</p>	<p>YEM-H1746</p>  <p>ISUZU 6RB1T 1-12111-2455</p>	<p>YEM-H1747</p>  <p>ISUZU SH200A3 6BG1T 8-97358-5740</p>
<p>YEM-H1748</p>  <p>ISUZU 6BB1 5-122111-013-0</p>	<p>YEM-H1749</p>  <p>ISUZU 6BD1T 1-12111-2401</p>	<p>YEM-H1750</p>  <p>ISUZU DA120 9-12111-196-0</p>	<p>YEM-H1751</p>  <p>ISUZU 6SD1T 1-12111-9130</p>	<p>YEM-H1752</p>  <p>ISUZU DA640 1-12111-1220</p>
<p>YEM-H1753</p>  <p>ISUZU 6SD1T 1-12111-6201</p>	<p>YEM-H1754</p>  <p>ISUZU 4JB1 8-97108622-2</p>	<p>YEM-H1755</p>  <p>ISUZU 3KR2 8-94375-1961</p>	<p>YEM-H1756</p>  <p>ISUZU 3LD1 8-97176887-0</p>	<p>YEM-H1757</p>  <p>ISUZU 6BF1 1-12111-3450</p>

活塞系列 PISTON SERIES

<p>YEM-H1758</p>  <p>ISUZU 6BG1(圆底)</p>	<p>YEM-H1759</p>  <p>ISUZU 4BD1 (高98MM)</p>	<p>YEM-H1760</p>  <p>ISUZU 6BG1 (大方底)</p>	<p>YEM-H1761</p>  <p>KOMATSU 4D120 6110-33-2132</p>	<p>YEM-H1762</p>  <p>KOMATSU S6D140 6211-31-2111</p>
<p>YEM-H1763</p>  <p>KOMATSU 6D105 6136-31-2112</p>	<p>YEM-H1764</p>  <p>KOMATSU 6D105 6136-32-2110</p>	<p>YEM-H1765</p>  <p>KOMATSU 4D94 6142-32-2120</p>	<p>YEM-H1766</p>  <p>KOMATSU 4D92 6140-31-2113</p>	<p>YEM-H1767</p>  <p>KOMATSU S6D95 6207-31-2141</p>
<p>YEM-H1768</p>  <p>KOMATSU PC60-7 6204-31-2141</p>	<p>YEM-H1769</p>  <p>KOMATSU S6D155 6127-31-2140</p>	<p>YEM-H1770</p>  <p>KOMATSU S6D170 6162-33-2140</p>	<p>YEM-H1771</p>  <p>KOMATSU 3D95S 6202-32-2140</p>	<p>YEM-H1772</p>  <p>KOMATSU 4D105-3 6130-32-2110</p>
<p>YEM-H1773</p>  <p>KOMATSU S6D125 6151-31-2511</p>	<p>YEM-H1774</p>  <p>KOMATSU S6D125 6151-31-2150</p>	<p>YEM-H1775</p>  <p>KOMATSU S6D140 6212-31-2150</p>	<p>YEM-H1776</p>  <p>KOMATSU S6D108 6222-31-2110</p>	<p>YEM-H1777</p>  <p>KOMATSU S6D110 6138-32-2112</p>
<p>YEM-H1778</p>  <p>KOMATSU S6D102 6735-31-2140</p>	<p>YEM-H1779</p>  <p>KOMATSU 4D95 6204-31-2121</p>	<p>YEM-H1780</p>  <p>KOMATSU S6D105 6137-32-2110</p>	<p>YEM-H1781</p>  <p>KOMATSU 4D130</p>	<p>YEM-H1782</p>  <p>KOMATSU 4D95 104mm</p>

活塞系列 PISTON SERIES

活塞系列 PISTON SERIES

<p>YEM-H1783</p>  <p>KOMATSU 4D95 98mm</p>	<p>YEM-H1784</p>  <p>KOMATSU S6D110</p>	<p>YEM-H1785</p>  <p>CAT 3306 9N-5250</p>	<p>YEM-H1786</p>  <p>CAT 3408 2W-0865</p>	<p>YEM-H1787</p>  <p>CAT 3408 1W9372</p>
<p>YEM-H1788</p>  <p>CAT 3306 8N3182</p>	<p>YEM-H1789</p>  <p>CAT 3306 107-3565</p>	<p>YEM-H1790</p>  <p>CAT S6KT 34317-10200</p>	<p>YEM-H1791</p>  <p>CAT 3204 2W4831</p>	<p>YEM-H1792</p>  <p>CAT PC300-6 S6D108 6222-33-2110</p>
<p>YEM-H1793</p>  <p>DAEWOO DB58T 65.02501-0562</p>	<p>YEM-H1794</p>  <p>DAEWOO D1146 65.02501-0074</p>	<p>YEM-H1795</p>  <p>DAEWOO D2366 65-02501-0031</p>	<p>YEM-H1796</p>  <p>DAEWOO DB58 (方底)</p>	<p>YEM-H1797</p>  <p>HINO DK10 13216-1080</p>
<p>YEM-H1798</p>  <p>HINO EL100 13216-1272</p>	<p>YEM-H1799</p>  <p>HINO H06CT 13216-1810</p>	<p>YEM-H1800</p>  <p>HINO DS50 13216-1050</p>	<p>YEM-H1801</p>  <p>YANMAR 3D72-2 YM119620-22090</p>	<p>YEM-H1802</p>  <p>YANMAR 3D82-3 YM119813-22080</p>
<p>YEM-H1803</p>  <p>YANMAR 4TNE94 YM129900-22080</p>	<p>YEM-H1804</p>  <p>YANMAR 3D78-1 YM129100-22080</p>	<p>YEM-H1805</p>  <p>NISSAN PD6 12010-96007</p>	<p>YEM-H1806</p>  <p>NISSAN FD33 12011-T9313</p>	<p>YEM-H1807</p>  <p>CUMMINS 6CT8.3 3923163</p>
<p>YEM-H1808</p>  <p>CUMMINS NT855 3803344</p>	<p>YEM-H1809</p>  <p>CUMMINS 6D114 6CT 6743-31-2110</p>	<p>YEM-H1810</p>  <p>CUMMINS B3.3</p>	<p>YEM-H1811</p>  <p>CUMMINS 6CT8.3</p>	<p>YEM-H1812</p>  <p>CUMMINS N1855 (无气门)</p>

品牌	机型 MODEL	零件号 PARTNO.
久保田 KUBOTA	Z482	
	V2003	
	V2203	蜗牛白边
	V2203	1A091-21113
	V2403	1G924
		1G790-2111-3
		1G790-2112-3
		1G790-2113-3
		1G796
		1G868
		1J881
		V1505
		D1503
		V1902
洋行 YANMAR	V2607	
	V3307	1G774-2111-0
	V3300	1G557-2111-0
	V3300	1C010-2111-0
	V3800	1J550-2111-0
		3TNE68
		3D72-2
		3D78-1
		3D82-3
		4D84-1
		4D84-2
		4D84-3
		4TNV88
		4TNE88
	4TNV94	
	4TNE94	
	4TNV98	
	4TNE98	
	D87T	
康明斯 CUMMINS	A2300	4900737
	B3.3 E2141	4025237
	B3.3 E2170	C6205312170
	B3.3 E2190	C6205312190
	QSB3.3	4944477
	6BT	3907163
	6BT	3926631
	6BT	3907156/3957795
	QSB5.9	3948465
	QSB6.7	4955160
	QSX15	4920306
	M11	4059948/4070653/3896030
	6CT240	3929565
	6CT240-565	3923164
	6CT	3929161
	6CT300	3917707
	6CT210	3923163
	6CT电喷	4933120
	NH220	199821/184800
	NT855	3048808
	NT855	3051555/3051556/3051557
K19	3096685	
K19	3096682	
K19	3096681	
LT10	3893751	
小松 KOMATSU	4D95 130-7	6208-31-2110
	4D95	6204-31-2121
	4D95K	6202-32-2120
	4D95L	6202-32-2140
	4D95+104凹	
	4D92	6140-31-2010
	4D94	6142-32-2110
	S6D95-5	6207-31-2141
	S6D95-6	6207-31-2180
	S6D102-7790	6735-31-2110

品牌	机型 MODEL	零件号 PARTNO.
小松 KOMATSU	S6D102(US)	
	S6D102-7795	6738-31-2110
	S6D102-0187	
	S6D102-8673	
	S4D105	6130-32-2110
	S6D105	6137-32-2110
	S6D107	6754-31-2110
	S6D108无气门位	6222-31-2116
	S6D108有气门位	6222-31-2116
	S6D110 方顶	6151-31-2150
	S6D125	6151-31-2171
	S6D125 BR	6151-31-2171
	S6D125	6150-31-2112
	S6D125	6151-32-2110
S6D125铁PC400-5	6152-32-2510	
S6D125铁PC400-6台湾	6151-31-2511	
S6D155	6127-31-2140	
S6D155	6128-31-2140	
6D105 PC200-1	6136-31-2112	
6D105 PC200-2	6136-32-2120	
五十铃 ISUZU	C223	8-94250-729-0
	C240	9-94326-225-0
	C190	5-12111-225-0
	4BC2	1-12111-775-0
	3LD1	8-97176887-0
	4LE1	8-97187582-0
	4LE2	8-97232604-0
	4JG2	8-94152-621-0
	4JB1	8-94152-177-1
	4JA1/OLD	8-94369-281-0
	4JA1/NEW	8-94562-892-0
	4BD1	1-12111-242-1
	4BE1	8-94438-989-1
	4HF1	5-87813-391-0
	4HF1	8-97095-585-1
	6BD1	5-12111-303-1
	6BD1	1-12111-777-0
	4HG1	8-97183-666-0
	4HG1	8-97219-032-0
	4HK1	8-97602-800-0
	6BG1-3R	1-12111-377-4
6BG1-3R	1-12111-435-0	
6BG1-3R	1-12111-918-0	
6BG1-4R	1-12111-574-0	
6SD1-3R	1-12111-620-1	
6SD1-4R	1-12111-651-1	
6HE1-T	8-94391-605-0	
6HE1	5-12111-837-0	
6HE1	3980	
6HK1	1-12111-526-1	
6HK1	1-12111-976-0	
6BB1	5-12111-013-0	
6BB1	5-12111-013-0	
6HH1	2420	
6HH1	5-12111-950-0	
6WG1	1-12111-964-0	
4BA1	5-12111-055-1	
10PE1	1-12111-813-0	
10PE1	1-12111-678-0	
10PD1	1-12111-804-0	
10PD1	1-12111-806-0	
E120	1-12111-080-1	
6WG1	1-12111-998-0	
6WG1	1-12111-887-0	
卡特 CAT	S6K	10200-975
	S6K	10200-985
	CAT320C S6KC	3437-01100
	CAT320D C6.4	
	CAT3306 3306	224-3015-4246 8N3102















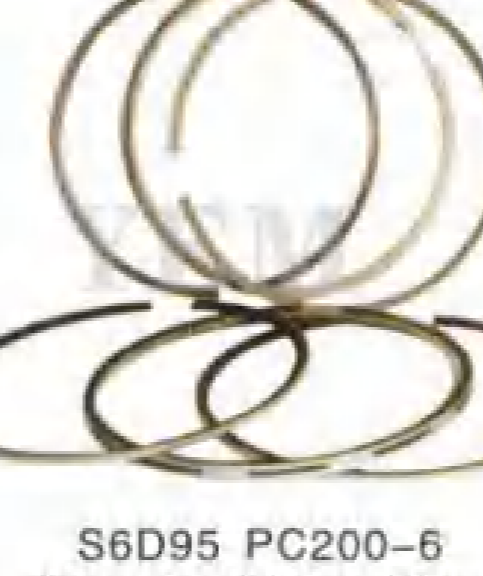



活塞系列 PISTON SERIES

活塞环系列 PISTON RING SERIES

品牌	机型 MODEL	零件号 PARTNO.
卡特 CAT	3306	8N3182
	3306	9N5250
	3306	1073565
	C7	238-2698/262-7330/262-9288
	3126	238-2726
	3116	107-7545/238-2716
	C9	197-9297-00
	C-9	265-1401-00
	3204/3208	2W4831
	3408	2W0865
大宇 DAEWOO	DB58T	65.02501-0561
	DB58	65.02501-0416
	D1146	65.02501-0031
	D1146	65.02501-0172
	D1146T	0785A
	D2366	65.02501-0031
	D2366T	65.02501-0164
	DE08T	0228B
	DE12	0222B
	DE12T	209
沃尔沃 Volvo	D4D	20460009
	D6D	20460010
	D7D BF4M	20450773
	D6E	VOE21291110
	D12D	VOE3183413
利勃海尔 LIEBHERR	R914	9883110
	R924	9883110
	R934	9883110
	R944	9883110
日野 HINO	W04D	13216-1460
	W06D	13211-2070
	H06CT	13216-1810
	H07CT	13211-2152/2062
	H07C	13216-2300
	H07C	13216-2290
	H07D	13216-2260
	H07D	13216-1980
	J05E	VH13013-E0390
	J08E	VH13013-E0390
	J08C	S130A/E0030
	J08C	13306-1060
	J08C	13306-1200
	J08C	13211-3211
	J08C	13216-2631
	F20C	13211-2502
	DK10	13216-1080
	EP100	13216-1450
	EL100	13216-1272
	DS50	13216-1050
P11C铸铁		
三菱 MITSUBISHI	4D30	
	4D31	ME012131
	4D31	ME012133
	4D31	ME012135
	4D32	ME017617
	4D32	ME012174
	4D33	ME012897
	4D33	ME016895
	4D34	ME011143
	4D35	ME014693
	4D55-STD	MD050021
	4D55+0.5	MD050021
	4D55-STD	MD050021
	4D55+0.5	MD050021
	4D56T-972	ME377963





















品牌	机型 MODEL	零件号 PARTNO.
三菱 MITSUBISHI	4D56T-696	ME377963
	4M40T	ME203223
	4M40T	ME200688
	4M40	ME201780
	S4Q	
	S4F	36717-41100
	S4S	32A17-00100
	S4E	34417-04100
	S4L	
	S4KT	
	S6A	32517-60200
	S6B	36217-30700
	6D11	
	6D14	ME072047
	6D14	ME032742
	6D15T	ME072055
	6D15T	ME032870
	6D16	ME072062
	6D16	ME072065
	6D16	ME072065
	6D16-OLD	ME072000
	6D16	ME078502
	6D16	ME300199
	6D17	ME072546
	6D20	ME052090
	6D22	ME052588
	6D22	ME052792
	6D22	ME052447
	6D22	ME052664
	6D24T	ME158096
6D24T	ME151409	
6D31	ME012858	
6D34	ME014160/013325	
6D34	ME014160	
6D34	ME088990	
6D34	ME082584	
6D34	ME220454	
6D34T	ME220470	
8DC9-NEW	ME090166	
6DB1	30017-90100	
6DB10		
8M20	ME161112	
日产 NISSAN	FE6T	
	FE6	12011-Z5768
	FE6	
	FE6	12013-Z5605
	FE6	
	FE6T	12011-Z5507
	PD6-1	12011-96009
	PD6-1	12011-96005
	PD6T	12011-96000
	PE6	
	PE6	12011-96508
	PE6T	12011-96564/96565
	PE6B	12011-96600
	TD25-STD	12010-63G11
	TD25+0.5	12010-63G11
	TD25-STD	12010-63G11
	TD27-STD	12010-63G11
	TD27+0.5	12010-63G11
	TD27-STD	12010-63G11
	TD27+0.5	12010-63G11
TD27T		
RE8		
PF6		
NE6		
QD32		



<p>YEM-H1813</p>  <p>6BG1(4道) Isuzu Piston Ring</p>	<p>YEM-H1814</p>  <p>S6D105 18070 Komatsu Piston Ring</p>	<p>YEM-H1815</p>  <p>6SD1(4道) Isuzu Piston Ring</p>	<p>YEM-H1816</p>  <p>4D95 Komatsu Piston Ring</p>	<p>YEM-H1817</p>  <p>S6D170 Komatsu Piston Ring</p>
<p>YEM-H1818</p>  <p>S6D95 PC200-6 Komatsu Piston Ring</p>	<p>YEM-H1819</p>  <p>4JB1 Isuzu Piston Ring</p>	<p>YEM-H1820</p>  <p>S6D115 Komatsu Piston Ring</p>	<p>YEM-H1821</p>  <p>4D95 Komatsu Piston Ring</p>	<p>YEM-H1822</p>  <p>6BD1 Isuzu Piston Ring</p>
<p>YEM-H1823</p>  <p>6BG1 Isuzu Piston Ring</p>	<p>YEM-H1824</p>  <p>6DS70 Mitsubishi Piston Ring</p>	<p>YEM-H1825</p>  <p>6D22T(6mm) Mitsubishi Piston Ring</p>	<p>YEM-H1826</p>  <p>6D14(4mm) Mitsubishi Piston Ring</p>	<p>YEM-H1827</p>  <p>6D16(平口) Mitsubishi Piston Ring</p>
<p>YEM-H1828</p>  <p>4M40 Mitsubishi Piston Ring</p>	<p>YEM-H1829</p>  <p>6D14(5mm) Mitsubishi Piston Ring</p>	<p>YEM-H1830</p>  <p>6D15(5mm) Mitsubishi Piston Ring</p>	<p>YEM-H1831</p>  <p>6D34 Mitsubishi Piston Ring</p>	<p>YEM-H1832</p>  <p>6D15(4mm) Mitsubishi Piston Ring</p>

缸套系列 LINER SERIES

缸套系列 LINER SERIES

<p>YEM-H1833</p>  <p>MITSUBISHI DIESEL ENGINE S6A 32507-12100</p>	<p>YEM-H1834</p>  <p>MITSUBISHI 6D16T ME041105</p>	<p>YEM-H1835</p>  <p>MITSUBISHI DIESEL ENGINE 4M40 Me202950</p>	<p>YEM-H1836</p>  <p>MITSUBISHI 6DS7 ME021843</p>	<p>YEM-H1837</p>  <p>MITSUBISHI 6DB1 30007-62200</p>
<p>YEM-H1838</p>  <p>MITSUBISHI 4D31T ME011604</p>	<p>YEM-H1839</p>  <p>MITSUBISHI 6D22T ME051500</p>	<p>YEM-H1840</p>  <p>MITSUBISHI S4E2 34407-05400</p>	<p>YEM-H1841</p>  <p>MITSUBISHI S4E 34407-00301</p>	<p>YEM-H1842</p>  <p>MITSUBISHI 4D33 ME013333</p>
<p>YEM-H1843</p>  <p>MITSUBISHI 6D34T ME013366</p>	<p>YEM-H1844</p>  <p>MITSUBISHI S4F</p>	<p>YEM-H1845</p>  <p>MITSUBISHI 6D15</p>	<p>YEM-H1846</p>  <p>MITSUBISHI 6D16</p>	<p>YEM-H1847</p>  <p>MITSUBISHI 6D31</p>
<p>YEM-H1848</p>  <p>MITSUBISHI 6D34</p>	<p>YEM-H1849</p>  <p>MITSUBISHI 6DS70</p>	<p>YEM-H1850</p>  <p>MITSUBISHI 6D15 (湿式薄边)</p>	<p>YEM-H1851</p>  <p>MITSUBISHI 6D14 (新款 NEW)</p>	<p>YEM-H1852</p>  <p>MITSUBISHI 6D22</p>
<p>YEM-H1853</p>  <p>MITSUBISHI 6D14 (旧款 OLD)</p>	<p>YEM-H1854</p>  <p>MITSUBISHI 6DB10</p>	<p>YEM-H1855</p>  <p>MITSUBISHI 6D20</p>	<p>YEM-H1856</p>  <p>MITSUBISHI S6K</p>	<p>YEM-H1857</p>  <p>KOMATSU S6D125 WHITE</p>
<p>YEM-H1858</p>  <p>KOMATSU S6D125 BLACK</p>	<p>YEM-H1859</p>  <p>KOMATSU S6D108 BLACK</p>	<p>YEM-H1860</p>  <p>KOMATSU S6D102 BLACK</p>	<p>YEM-H1861</p>  <p>KOMATSU S6D102 WHITE</p>	<p>YEM-H1862</p>  <p>KOMATSU S6D95 WHITE</p>

<p>YEM-H1863</p>  <p>KOMATSU S6D95 BLACK</p>	<p>YEM-H1864</p>  <p>KOMATSU S6D105 BLACK</p>	<p>YEM-H1865</p>  <p>KOMATSU S6D108 WHITE</p>	<p>YEM-H1866</p>  <p>KOMATSU S6D110 WHITE</p>	<p>YEM-H1867</p>  <p>KOMATSU 4D94</p>
<p>YEM-H1868</p>  <p>KOMATSU 4D120</p>	<p>YEM-H1869</p>  <p>KOMATSU S6D155</p>	<p>YEM-H1870</p>  <p>KOMATSU S6D105</p>	<p>YEM-H1871</p>  <p>KOMATSU S6D108 6222-21-2220</p>	<p>YEM-H1872</p>  <p>KOMATSU 4D105 6130-22-2213</p>
<p>YEM-H1873</p>  <p>KOMATSU S6D105 6136-21-2210</p>	<p>YEM-H1874</p>  <p>KOMATSU S6D170 6162-23-2210</p>	<p>YEM-H1875</p>  <p>KOMATSU 4D130 6115-21-2211</p>	<p>YEM-H1876</p>  <p>KOMATSU S6D110 6138-21-2210</p>	<p>YEM-H1877</p>  <p>ISUZU 6HK1</p>
<p>YEM-H1878</p>  <p>ISUZU E120</p>	<p>YEM-H1879</p>  <p>ISUZU 6BF1</p>	<p>YEM-H1880</p>  <p>ISUZU 4LE2</p>	<p>YEM-H1881</p>  <p>ISUZU 6SA1</p>	<p>YEM-H1882</p>  <p>ISUZU C240</p>
<p>YEM-H1883</p>  <p>ISUZU DA640 9-11261-288-0</p>	<p>YEM-H1884</p>  <p>ISUZU 6BD1T 1-11261-118-0</p>	<p>YEM-H1885</p>  <p>ISUZU 6BG1</p>	<p>YEM-H1886</p>  <p>ISUZU 6BD1</p>	<p>YEM-H1887</p>  <p>ISUZU 4JB1</p>
<p>YEM-H1888</p>  <p>ISUZU 6BB1</p>	<p>YEM-H1889</p>  <p>ISUZU 6SD1</p>	<p>YEM-H1890</p>  <p>ISUZU 6RB1</p>	<p>YEM-H1891</p>  <p>ISUZU 6BG1T 1-11261-119-0</p>	<p>YEM-H1892</p>  <p>ISUZU 6HK1T 8-94391-602-0</p>

缸套系列 LINER SERIES

 CAT 3204 9N-6275	 CAT 3306 2P-8889	 CAT S6KT 5I-7523	 CAT 330C C9 190-3562	 CUMMINS 6BT5.9 3904166	 CUMMINS NH220 6610-21-2212
 CUMMINS 6D114	 CUMMINS 6CT	 CUMMINS NH220	 CUMMINS B3.3	 CUMMINS 6BT	 CUMMINS NT855
 HINO EP100(白)	 HINO EH700	 HINO H07CT(白)	 HINO H07CT 11467-1200	 HINO H06CT(黑)	 HINO H06CT(白)
 HINO Ds50 11467-1550	 HINO EM100	 HINO EK100	 HINO EL100 11467-1270	 NISSAN ND6 11012-95001	 NISSAN BD30 11012-54T00
 NISSAN Ed33	 NISSAN Fd33	 NISSAN Pd6	 NISSAN Pe6	 DAEWOO DB58	 DAEWOO Dh330
 DAEWOO D2366	 DAEWOO D1146	 YANMAR 4D84	 YANMAR 4TNE94	 YANMAR 4TNE94	 YANMAR 4TNE88

缸套系列 LINER SERIES

品牌	机型 MODEL	零件号 PARTNO.	尺寸 SIZE
久保田 KUBOTA	D1503		Φ86.6*Φ81.6*Φ156
	V2203		Φ86*Φ90.5*Φ150
	V2203+A		Φ86*Φ91*Φ150
	V3300		Φ97*Φ101.6*Φ187
	V3800		Φ99*Φ104*191
	3TNE82		Φ86.5*Φ90.5*Φ128
洋行 YANMAR	4T84		Φ83*Φ88*Φ150
	4T88		Φ87*Φ91*Φ182
	V88+A		Φ87*Φ92*Φ182
	4TNE94		Φ93*Φ98*Φ190
	4TNE94		Φ93*Φ99*Φ190
	4TNE98		Φ97*Φ101.6*Φ187
	4TNE98+A		Φ97*Φ102*Φ187
康明斯 CUMMINS	A2300.F	4900214	Φ88*Φ91*Φ153
	B3.3		
	6BT		Φ101*Φ104.5*200
	6BT	3904166	Φ101*Φ105*200
	6BT		Φ101*Φ106*200
	6BT		Φ101*Φ107*200
	6CT	3919937	Φ114*Φ131*236
	6CT	3802406	Φ114*Φ131*236
	6CT	3802407	Φ114*Φ131*236
	M11/LT10	3080760	Φ125*Φ146*241
NH220	6610-21-2212		
NT855	3055099	Φ139.7*Φ166.7*288.2	
K19	4009220		
小松 KOMATSU	4D95	6207-21-2110	Φ94.2*Φ98*180
	S4D95	6207-21-2121	Φ94.2*Φ98*180
	6D95		Φ94*Φ98*181
	6D95		Φ94*Φ99*181
	6D95		Φ94*Φ100*181
	6D102	6736-29-2140	Φ101*Φ105*200
	S6D105	6136-21-2210	Φ105*Φ127*233
	6D107		Φ106*Φ110*203
	6D107		Φ106*Φ111*203
	6D107		Φ106*Φ112*203
	S6D108.F		108*111.3*220
	S6D110	6138-21-2210	Φ110*Φ115*225
	S6D125	6150-21-2221	Φ125*Φ153*256
	S6D140		
	S6D155	6128-21-2215	Φ155*Φ184*327
	S6D170	6162-23-2210	
五十铃 ISUZU	3LD1		
	4LE1		Φ84*Φ89*Φ150
	4LE2		
	C240.F	9-11261-230-0	Φ86*Φ88*Φ178
	C190	9-11261-210-0	
	C223	9-11261-015-1	
	4JA1	8-94110-114-0	
	4JB1	8-94247-861-0	
	4JG1	8-97176-701-0	
	4BC2	8-97176-701-0	
	4BE1	5-11261-016-2	
	4HF1	8-94389-276-1	Φ112*Φ115*180
	4HG1	8-97351-558-0	Φ115*Φ118*180
	6BD1		
6BG1	1-11261-250-0		
DA120	9-87692-095-0	Φ100*Φ119*220	

品牌	机型 MODEL	零件号 PARTNO.	尺寸 SIZE
五十铃 ISUZU	6SD1T	1-11261-106-2	Φ120*Φ123*239
	6HE1	8-94396-332-0	Φ110*Φ113*210
	6HH1		
	6RB1/E120		Φ132*Φ137*266
	6HK1.F		115*118*210
卡特 CAT	3406	2W6000	Φ137.2*Φ165*274
	3116		
	C7		104*109.3*197
	C9		
	S6KT	5I-7523	Φ101.2*Φ105*196
3306	2P8889	Φ120.7*Φ143*255	
大宇 DAEWOO	DB58.F	65.01201-0067	Φ102*Φ106*206
	D1146.F	65.01201-0050	Φ111*Φ114*234
	D2366.F	65.01201-0051	Φ123*Φ127*270
日野 HINO	WO4D	11467-1781	Φ104*Φ107*201
	W06D	11467-1771	Φ104*Φ107*200
	EL100		Φ116*Φ138*222
	EK100	11467-1270	Φ137*Φ164*267
	EF750	11467-1091	Φ137*Φ165*248
	EF550	11407-1690	Φ135*Φ165*248
	F17C	11467-1702	Φ139*Φ166*248
	EH700	11467-1200	
	H07CT	11467-1210	Φ110*Φ113*204
	EH100	11467-1040	Φ105*Φ110*206
J05E/J08E.F	11467-2611	Φ112*Φ115*203	
沃尔沃 volvo	D6D		Φ97*Φ101*104.8
	D6D+		Φ97*Φ102*104.8
	D6D.F		Φ98*Φ101*104.8
	D6E		Φ97*Φ101*188
	D6E+		Φ97*Φ102*188
	D6E.F		Φ98*Φ101*188
尼桑	BD30		
三菱 MITSUBISHI	4D55	MD050430	Φ90*Φ94.1*164.5
	4D56	MD103648	Φ90*Φ94.1*164.5
	4D31/6D31	ME011626	Φ99*Φ104*191
	6D31+A		Φ99*Φ105*191
	4D34/4D32/6D34	ME013366	Φ103*Φ108*197.5
	6D34+A		Φ102*Φ109*Φ197
	4D33	ME013333	Φ107*Φ112*200
	4D35	ME013678	Φ109*Φ114*200
	S4S	32A07-00300	
	4M40		Φ94*Φ98*Φ168
	S4L		Φ77*Φ81.6*Φ156
	S4Q2		Φ86.5*Φ92*Φ160
	S6K	34307-00501	Φ101.2*Φ105*196
	6D14	ME031617	Φ110*Φ130*206
	6D14T	ME071198	Φ110*Φ130*206
	6D15	ME031656	Φ112*Φ117*206
	6D16.F	ME071224	Φ118*Φ122*205
	6D16新		Φ118*Φ122*205
6D16T	ME041105	Φ118*Φ122*205	
6D22	ME051500	Φ130*Φ155.5*261.5	
6D22T	ME051217	Φ130*Φ155.5*261.5	
8DC8	ME061036	Φ135*Φ163*229.7	
8DC9	ME062602	Φ135*Φ163*260.6	
8DC11	ME060439	Φ142*Φ163*259.5	

大小瓦 ENGINE BEARING

气门类 VALVES

YEM—H1929



YEM—H1930



APPLICATION	MODEL	APPLICATION	MODEL
CAT	S4K/S6K	CUMMINS	K19
CAT	3306/3304	CUMMINS	6CT/6D114
CAT	3406	ISUZU	6BD1
CAT	3408	ISUZU	6RB1
CAT	3204	ISUZU	4JB1
CAT	3208	ISUZU	6SD1
KOMATSU	6D140	ISUZU	6BD1
KOMATSU	4D105-3	mitsubishi	6D22
KOMATSU	S6D155	mitsubishi	6D31
KOMATSU	S6D102	mitsubishi	6D14
KOMATSU	S6D108	mitsubishi	6D34
KOMATSU	4D120	mitsubishi	S4F
KOMATSU	S6D110	mitsubishi	4M40
KOMATSU	PC200-6 6D95	mitsubishi	6D14
KOMATSU	S6D95	mitsubishi	6D31
KOMATSU	S6D105	YANMAR	4D84
KOMATSU	4D130	YANMAR	4TNV94
KOMATSU	S6D170	YANMAR	4TNE94
KOMATSU	4D105-3	YANMAR	4D94
KOMATSU	4D95	DEEWO	D1146
KOMATSU	6D105	DEEWO	D2366
KOMATSU	S6D105	DEEWO	DH280-3
KOMATSU	6D110	DEEWO	DH220-3
KOMATSU	S6D125	DEEWO	DH220-5
KOMATSU	4D120	HINO	H06CT
CUMMINS	6BT	HINO	EP100
CUMMINS	NT855	HINO	EL100
CUMMINS	NH220	HINO	H07CT

APPLICATION	MODEL	APPLICATION	MODEL
CAT	S4K/S6K	CUMMINS	K19
CAT	3306/3304	CUMMINS	6CT/6D114
CAT	3406	ISUZU	6BD1
CAT	3408	ISUZU	6RB1
CAT	3204	ISUZU	4JB1
CAT	3208	ISUZU	6SD1
KOMATSU	6D140	ISUZU	6BD1
KOMATSU	4D105-3	mitsubishi	6D22
KOMATSU	S6D155	mitsubishi	6D31
KOMATSU	S6D102	mitsubishi	6D14
KOMATSU	S6D108	mitsubishi	6D34
KOMATSU	4D120	mitsubishi	S4F
KOMATSU	S6D110	mitsubishi	4M40
KOMATSU	PC200-6 6D95	mitsubishi	6D14
KOMATSU	S6D95	mitsubishi	6D31
KOMATSU	S6D105	YANMAR	4D84
KOMATSU	4D130	YANMAR	4TNV94
KOMATSU	S6D170	YANMAR	4TNE94
KOMATSU	4D105-3	YANMAR	4D94
KOMATSU	4D95	DEEWO	D1146
KOMATSU	6D105	DEEWO	D2366
KOMATSU	S6D105	DEEWO	DH280-3
KOMATSU	6D110	DEEWO	DH220-3
KOMATSU	S6D125	DEEWO	DH220-5
KOMATSU	4D120	HINO	H06CT
CUMMINS	6BT	HINO	EP100
CUMMINS	NT855	HINO	EL100
CUMMINS	NH220	HINO	H07CT



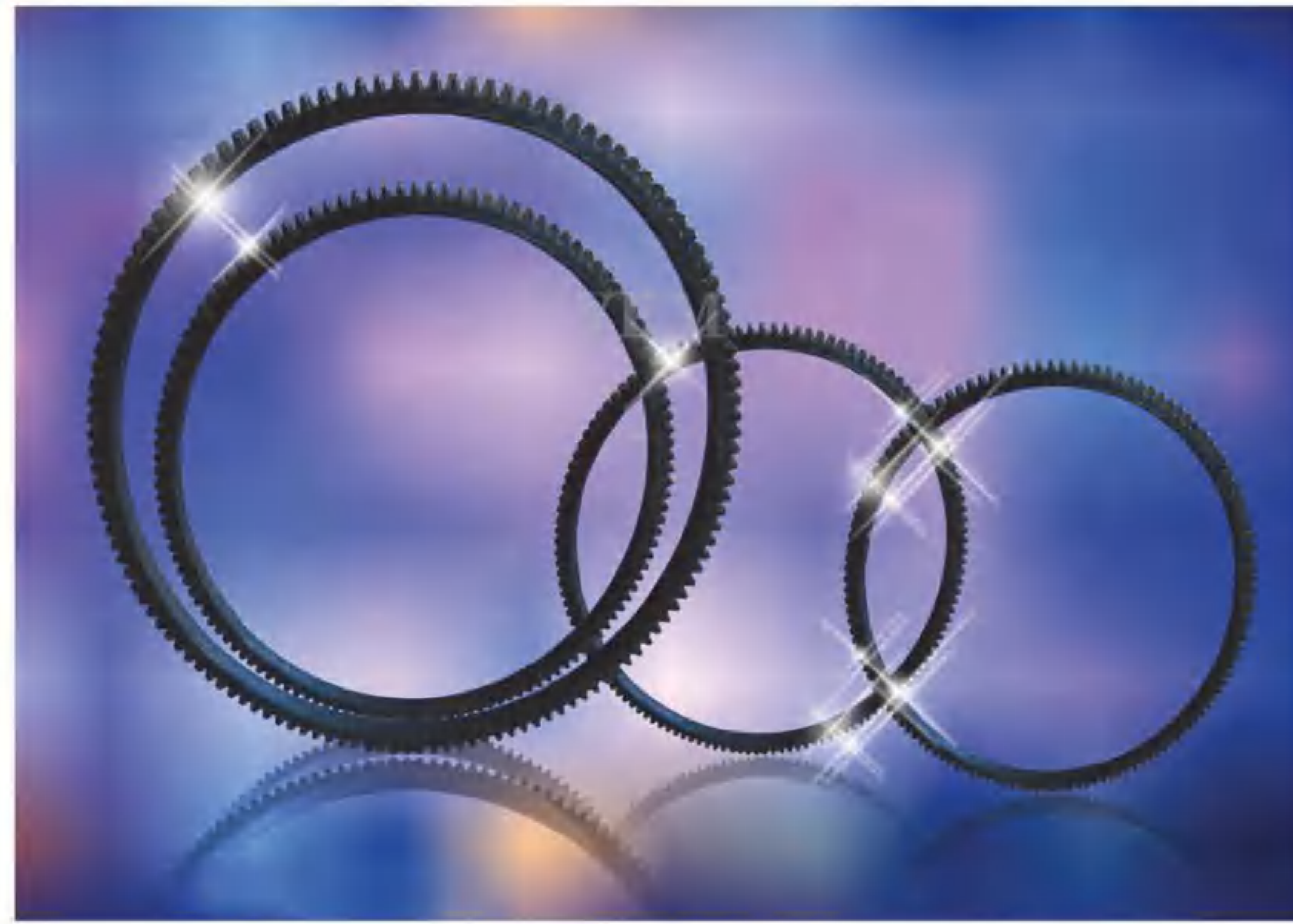











飞轮齿圈 FLY WHEEL GEAR RING

























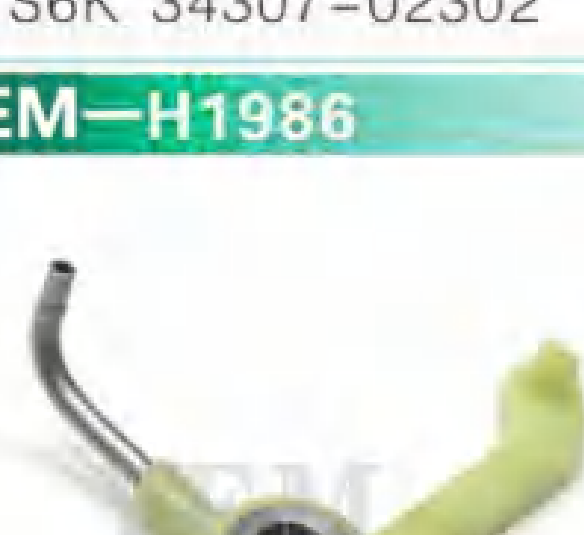
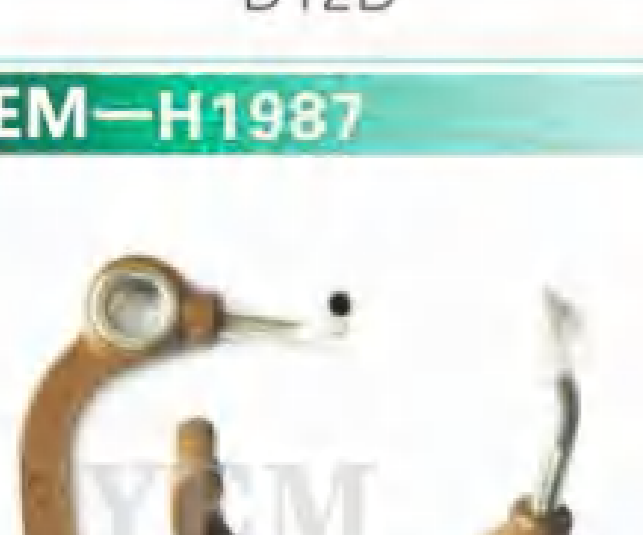
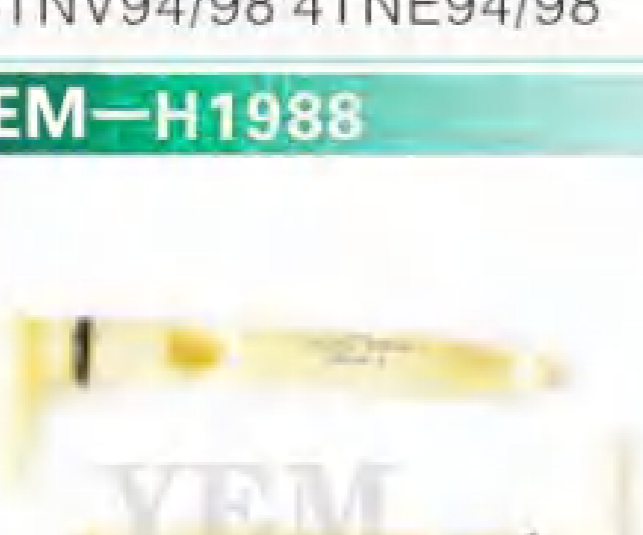
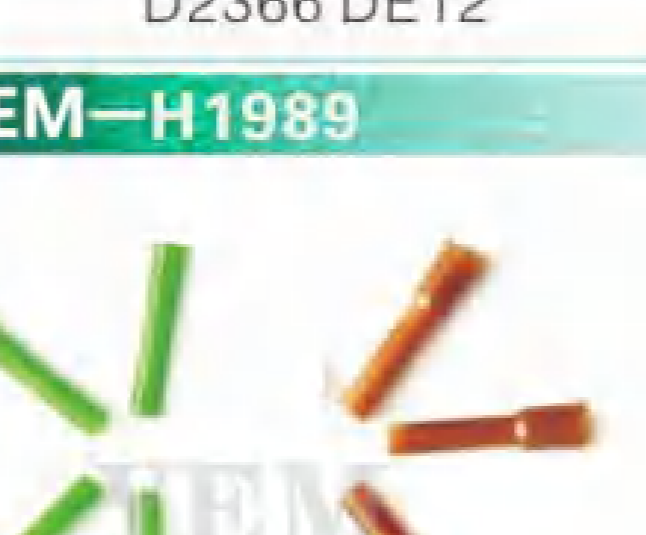

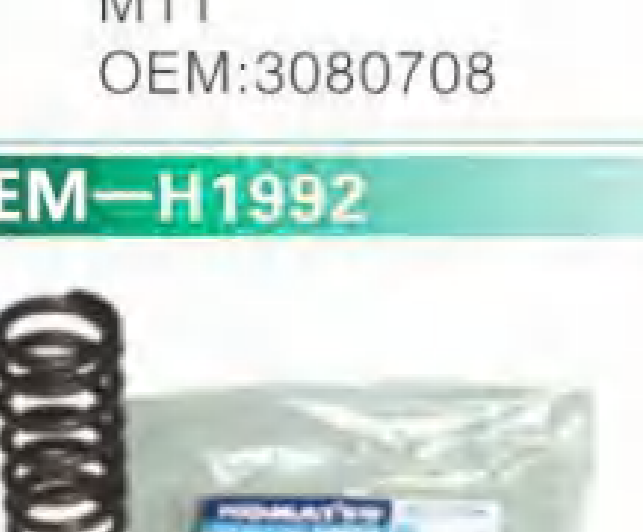

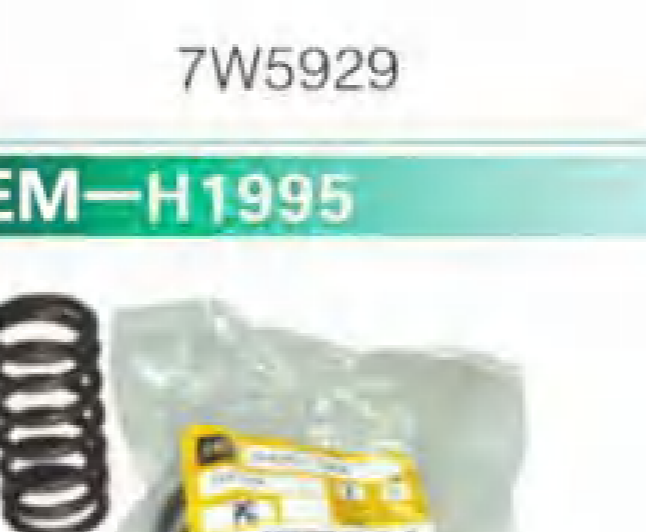

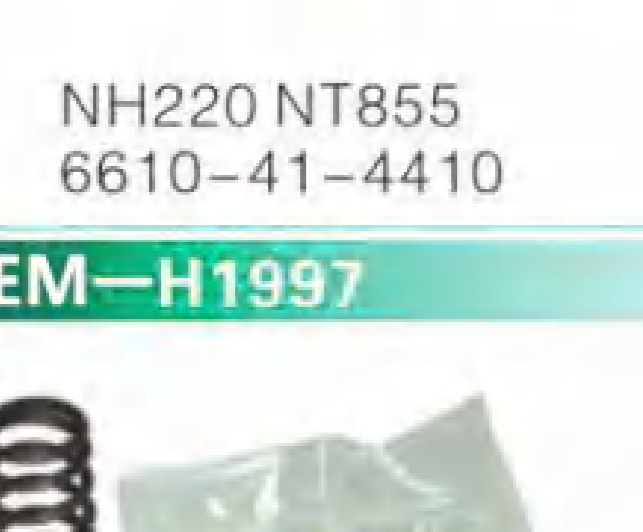
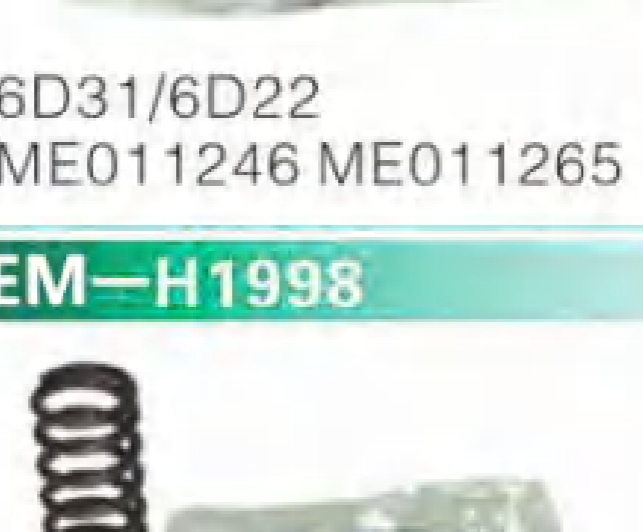
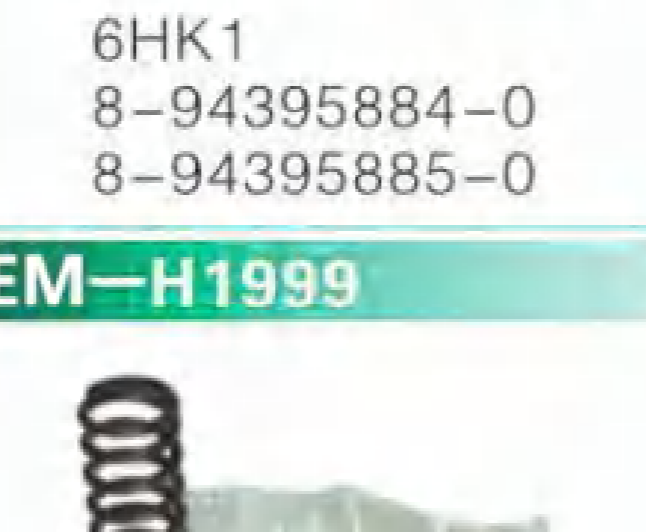
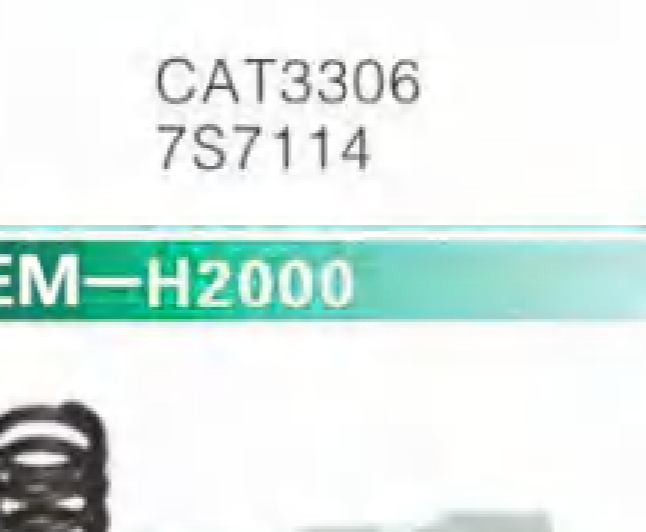

型号	齿数	型号	齿数
4D102	127T	6HK1电喷	141T
S4F	110T	6HK1直喷	140T
4M40	120T	6SD1	140T
4TNV94	114T	EC210	129T
4BG1	128T	J05	129T
4TNV98	129T	6D125	152T
C7	126T	C9	113T
4D102	108T	DE08	152T

飞轮齿圈 FLY WHEEL GEAR RING

<p>YEM-H1946</p>  <p>4JB1 108齿</p>	<p>YEM-H1947</p>  <p>4D31 110齿</p>	<p>YEM-H1948</p>  <p>4D95 110齿</p>	<p>YEM-H1949</p>  <p>4D32 110齿</p>	<p>YEM-H1950</p>  <p>6D102 127齿</p>
<p>YEM-H1951</p>  <p>6D95 127齿</p>	<p>YEM-H1952</p>  <p>S6K 127齿</p>	<p>YEM-H1953</p>  <p>S4K 127齿</p>	<p>YEM-H1954</p>  <p>4BD1 128齿</p>	<p>YEM-H1955</p>  <p>6BG1 129齿</p>
<p>YEM-H1956</p>  <p>DB58 129齿</p>	<p>YEM-H1957</p>  <p>6D14 129齿</p>	<p>YEM-H1958</p>  <p>6D15 129齿</p>	<p>YEM-H1959</p>  <p>6D16 129齿</p>	<p>YEM-H1960</p>  <p>6D31 129齿</p>
<p>YEM-H1961</p>  <p>6D34 129齿</p>	<p>YEM-H1962</p>  <p>4HK1 129齿</p>	<p>YEM-H1963</p>  <p>6BD1 129齿</p>	<p>YEM-H1964</p>  <p>6D34 129齿</p>	<p>YEM-H1965</p>  <p>6SD1 140齿</p>
<p>YEM-H1966</p>  <p>6D108 148齿</p>	<p>YEM-H1967</p>  <p>6D125 148齿</p>	<p>YEM-H1968</p>  <p>6HK1电喷 141T</p>	<p>YEM-H1969</p>  <p>6CT8.3 128齿</p>	<p>YEM-H1970</p>  <p>6CT8.3 158齿</p>

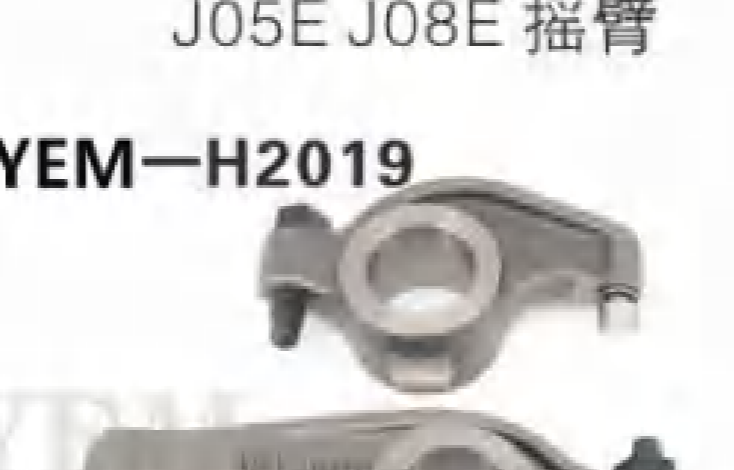
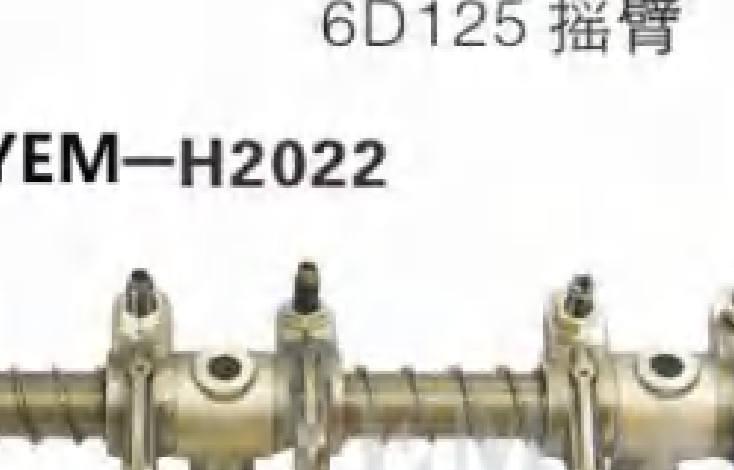

























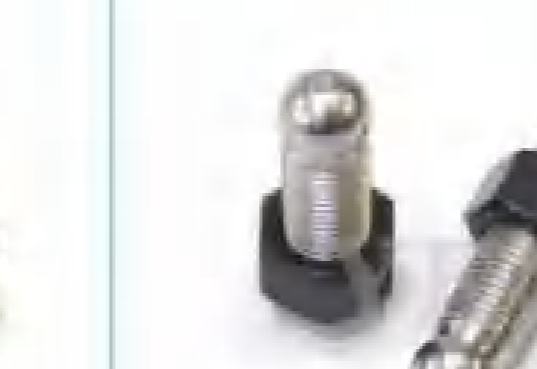





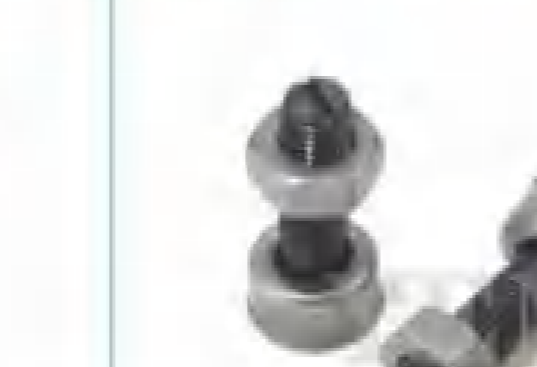

<p>YEM-H1931</p>  <p>4D102 108T 飞轮齿圈</p>	<p>YEM-H1932</p>  <p>S4F 110T 飞轮齿圈</p>	<p>YEM-H1933</p>  <p>C9 113T 飞轮齿圈</p>	<p>YEM-H1934</p>  <p>4TNV94 114T 飞轮齿圈</p>	<p>YEM-H1935</p>  <p>4M40 120T 飞轮齿圈</p>
<p>YEM-H1936</p>  <p>C7 126T 飞轮齿圈</p>	<p>YEM-H1937</p>  <p>4D102 127T 飞轮齿圈</p>	<p>YEM-H1938</p>  <p>4BG1 128T 飞轮齿圈</p>	<p>YEM-H1939</p>  <p>J05 129T 飞轮齿圈</p>	<p>YEM-H1940</p>  <p>EC210 129T 飞轮齿圈</p>
<p>YEM-H1941</p>  <p>4TNV98 129T 飞轮齿圈</p>	<p>YEM-H1942</p>  <p>6HK1直喷 140T 飞轮齿圈</p>	<p>YEM-H1943</p>  <p>6SD1 140T 飞轮齿圈</p>	<p>YEM-H1944</p>  <p>6D125 152T 飞轮齿圈</p>	<p>YEM-H1945</p>  <p>DE08 152T 飞轮齿圈</p>

<p>YEM-H1971</p>  <p>6D14/15/16 ME014316</p>	<p>YEM-H1972</p>  <p>6D31 6D34</p>	<p>YEM-H1973</p>  <p>6D108 6222-231810</p>	<p>YEM-H1974</p>  <p>PC400-5 6151-21-1740</p>	<p>YEM-H1975</p>  <p>PC400-6 6151-22-1810</p>
<p>YEM-H1976</p>  <p>D1146 65.01601-6003C</p>	<p>YEM-H1977</p>  <p>J05E J08E</p>	<p>YEM-H1978</p>  <p>DB58</p>	<p>YEM-H1979</p>  <p>4HK1 6HK1 8-98020649-0</p>	<p>YEM-H1980</p>  <p>6BD1 6BG1 1-13342110-0</p>
<p>YEM-H1981</p>  <p>S6K 34307-02302</p>	<p>YEM-H1982</p>  <p>D12D</p>	<p>YEM-H1983</p>  <p>4TNV94/98 4TNE94/98</p>	<p>YEM-H1984</p>  <p>D2366 DE12</p>	<p>YEM-H1985</p>  <p>6SD1</p>
<p>YEM-H1986</p>  <p>4D107/6D107 OEM:4937308</p>	<p>YEM-H1987</p>  <p>M11 OEM:3080708</p>	<p>YEM-H1988</p>  <p>NT855 OEM:3013591</p>	<p>YEM-H1989</p>  <p>4D102/6D114 OEM:3901020/3928031</p>	<p>YEM-H1990</p>  <p>7W5929</p>
<p>YEM-H1991</p>  <p>1W6541</p>	<p>YEM-H1992</p>  <p>NH220 NT855 6610-41-4410</p>	<p>YEM-H1993</p>  <p>6D31/6D22 ME011246 ME011265</p>	<p>YEM-H1994</p>  <p>6HK1 8-94395884-0 8-94395885-0</p>	<p>YEM-H1995</p>  <p>CAT3306 7S7114</p>
<p>YEM-H1996</p>  <p>6D155 6127-41-4410</p>	<p>YEM-H1997</p>  <p>PC200-6 6D102 Short/Long</p>	<p>YEM-H1998</p>  <p>6D125 IN:6150-41-4420 EX:6150-41-4411</p>	<p>YEM-H1999</p>  <p>6BD1/6BG1 1-12561099-1 5-12561009-0</p>	<p>YEM-H2000</p>  <p>洋马4D84/4D88 4TNV94/4TNE94</p>

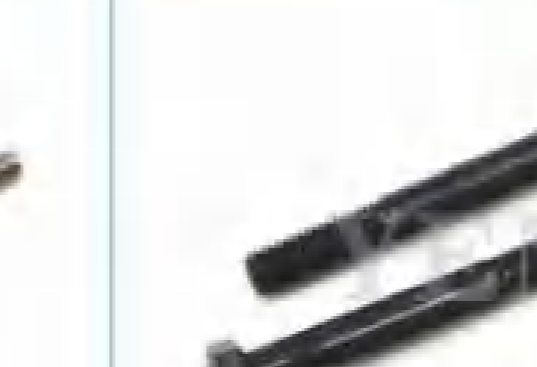
<p>YEM-H2001</p>  <p>4D34</p>	<p>YEM-H2002</p>  <p>6D95</p>	<p>YEM-H2003</p>  <p>6BD1</p>	<p>YEM-H2004</p>  <p>4JB1</p>
<p>YEM-H2005</p>  <p>4D31 摇臂</p>	<p>YEM-H2006</p>  <p>S6K 摇臂</p>	<p>YEM-H2007</p>  <p>6SD1 摇臂</p>	<p>YEM-H2008</p>  <p>D12D 摇臂</p>
<p>YEM-H2009</p>  <p>4TNV94 摇臂</p>	<p>YEM-H2010</p> 	<p>YEM-H2011</p> 	<p>YEM-H2012</p> 
<p>YEM-H2013</p>  <p>6D125 -6丁字架</p>	<p>YEM-H2014</p>  <p>S6K 摇臂座</p>	<p>YEM-H2015</p>  <p>J05E J08E 摇臂</p>	<p>YEM-H2016</p>  <p>4TNV94 摇臂</p>
<p>YEM-H2017</p>  <p>6HK1 摇臂</p>	<p>YEM-H2018</p>  <p>6D125 摇臂</p>	<p>YEM-H2019</p>  <p>C9 摇臂 161-3391</p>	<p>YEM-H2020</p>  <p>6D102 摇臂总成</p>
<p>YEM-H2021</p>  <p>6D114 摇臂总成</p>	<p>YEM-H2022</p>  <p>S6K 摇臂总成</p>	<p>YEM-H2023</p>  <p>4JB1 摇臂总成</p>	<p>YEM-H2024</p>  <p>J08E 摇臂总成</p>
<p>YEM-H2025</p>  <p>4HK1摇臂总成</p>	<p>YEM-H2026</p>  <p>6HK1摇臂总成</p>	<p>YEM-H2027</p> 	<p>YEM-H2028</p> 

各种螺丝系列 CON ROD BOLT & CLY HEAD BOLT SERIES

发动机配件 ENGINE PARTS

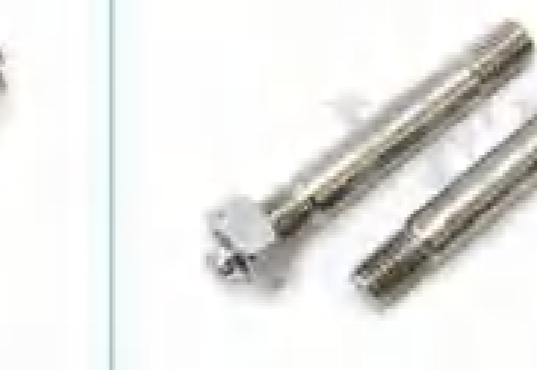
<p>YEM-H2027</p>  <p>6D102 缸盖螺丝 Cylinder head bolt</p>	<p>YEM-H2028</p>  <p>4JB1 6D95 缸盖螺丝 Cylinder head bolt</p>	<p>YEM-H2029</p>  <p>6D31缸盖螺丝 Cylinder head bolt</p>	<p>YEM-H2030</p>  <p>6BD1 缸盖螺丝 Cylinder head bolt</p>	<p>YEM-H2031</p>  <p>6D105 缸盖螺丝 Cylinder head bolt</p>	<p>YEM-H2032</p>  <p>6HK1 缸盖螺丝 Cylinder head bolt</p>
<p>YEM-H2033</p>  <p>6D102 连杆螺丝 Con rod spring</p>	<p>YEM-H2034</p>  <p>S6K 连杆螺丝 Con rod spring</p>	<p>YEM-H2035</p>  <p>6D105 连杆螺丝 Con rod spring</p>	<p>YEM-H2036</p>  <p>4TNV94 连杆螺丝 Con rod spring</p>	<p>YEM-H2037</p>  <p>6D125 连杆螺丝 Con rod spring</p>	<p>YEM-H2038</p>  <p>J05E 连杆螺丝 Con rod spring</p>
<p>YEM-H2039</p>  <p>6BD1 连杆螺丝 Con rod spring</p>	<p>YEM-H2040</p>  <p>6D102 气门罩螺丝</p>	<p>YEM-H2041</p>  <p>6D31 6D34 喷嘴螺丝</p>	<p>YEM-H2042</p>  <p>6D107 喷嘴螺丝</p>	<p>YEM-H2043</p>  <p>4HK1 6HK1 气门调整螺丝</p>	<p>YEM-H2044</p>  <p>6D102 6D114 气门调整螺丝</p>
<p>YEM-H2045</p>  <p>NV94 NV98 气门调整螺丝</p>	<p>YEM-H2046</p>  <p>D1146 2366 气门调整螺丝</p>	<p>YEM-H2047</p>  <p>6BD1 气门调整螺丝</p>	<p>YEM-H2048</p>  <p>6D14 6D15 排气管螺丝</p>	<p>YEM-H2049</p>  <p>6D95 气门调整螺丝</p>	<p>YEM-H2050</p>  <p>J05 J08 气门调整螺丝</p>
<p>YEM-H2051</p>  <p>4TNV94/98 4TNE94/98 喷嘴螺丝</p>	<p>YEM-H2052</p>  <p>6D31 6D34 喷嘴螺丝</p>	<p>YEM-H2053</p>  <p>6BD1-6HK1 喷嘴螺丝</p>	<p>YEM-H2054</p>  <p>J05 J08 喷嘴螺丝</p>	<p>YEM-H2055</p>  <p>6BD1/DB58 排气管螺丝</p>	<p>YEM-H2056</p>  <p>6D95 排气管螺丝</p>
<p>YEM-H2057</p>  <p>S6K 排气管螺丝</p>	<p>YEM-H2058</p>  <p>6D102/107/114 排气管螺丝</p>	<p>YEM-H2059</p>  <p>6D14 6D15 6D16 排气管螺丝</p>	<p>YEM-H2060</p>  <p>4TNV94 排气管螺丝 (3)</p>	<p>YEM-H2061</p>  <p>J05 J08 排气管螺丝</p>	<p>YEM-H2062</p>  <p>4HK1 6HK1 排气管螺丝</p>

<p>YEM-H2063</p>  <p>曲轴齿PC200-6 Crankshaft Gear</p>	<p>YEM-H2064</p>  <p>曲轴齿6D95 Crankshaft Gear</p>	<p>YEM-H2065</p>  <p>PC400-6 6D125 Crankshaft Gear</p>	<p>YEM-H2066</p>  <p>S6K Crankshaft Gear</p>	<p>YEM-H2067</p>  <p>PC360-7 6D114 Crankshaft Gear</p>
<p>YEM-H2068</p>  <p>曲轴齿 6BD1/6BG1/Bd58 Crankshaft Gear</p>	<p>YEM-H2069</p>  <p>曲轴齿 6D31 Crankshaft Gear</p>	<p>YEM-H2070</p>  <p>油泵齿 Pump Gear PC200-6 6D102</p>	<p>YEM-H2071</p>  <p>凸轮轴齿 Crankshaft Gear PC200-6 6D102</p>	<p>YEM-H2072</p>  <p>凸轮轴塞片 6D102</p>
<p>YEM-H2073</p>  <p>6BD1/6BG1/DB58</p>	<p>YEM-H2074</p>  <p>S6K</p>	<p>YEM-H2075</p>  <p>6D114 齿轮室盖</p>	<p>YEM-H2076</p>  <p>6D102 齿轮室盖</p>	<p>YEM-H2077</p>  <p>PC360-7 6D114 齿轮室</p>
<p>YEM-H2078</p>  <p>6D102 齿轮室</p>	<p>YEM-H2079</p>  <p>6D102 曲轴油封座 Crankshaft Sealseat</p>	<p>YEM-H2080</p>  <p>E200B/320C 柴油泵连接盘 Damper Plate</p>	<p>YEM-H2081</p>  <p>日立信号阀</p>	<p>YEM-H2082</p>  <p>各种曲轴凸轮轴半圆键</p>
<p>YEM-H2083</p>  <p>708-2L-25521</p>	<p>YEM-H2083</p>  <p>708-2L-25611</p>	<p>YEM-H2083</p>  <p>708-2L-25731 SPOOL</p>	<p>YEM-H2083</p>  <p>708-2L-25223 SLEEVE</p>	<p>YEM-H2083</p>  <p>708-2L-25232 SPOOL</p>
PC200-6 6D102 提升器阀芯				
<p>YEM-H2084</p>  <p>708-25-15120 2支</p>	<p>YEM-H2084</p>  <p>708-25-15180 2支</p>	<p>YEM-H2084</p>  <p>708-25-15270 2支</p>	<p>YEM-H2084</p>  <p>708-25-15280 2支</p>	<p>YEM-H2084</p>  <p>708-25-15141 4支</p>
<p>YEM-H2084</p>  <p>708-25-15141 4支</p>	<p>YEM-H2084</p>  <p>708-25-17160 2支</p>	<p>YEM-H2084</p>  <p>708-25-17211 2支</p>	<p>YEM-H2084</p>  <p>708-25-17220 2支</p>	<p>YEM-H2084</p>  <p>708-23-18161 1支</p>
<p>YEM-H2084</p>  <p>708-23-18120 1支</p>	<p>YEM-H2084</p>  <p>708-23-18130 1支</p>	<p>YEM-H2084</p>  <p>708-23-18140 2支</p>	<p>YEM-H2084</p>  <p>708-23-18150 2支</p>	<p>YEM-H2084</p>  <p>708-25-17150 2支</p>

发动机配件 ENGINE PARTS

气门筷子 Push Rod



高压油泵 HIGH PRESSURE OILPUMP



高压油泵 HIGH PRESSURE OIL PUMP

喷油嘴 NOZZLE INJECTORS

YEM-H2140



高压油泵

YEM-H2141



高压油泵

YEM-H2142



高压油泵

YEM-H2143



高压油泵

YEM-H2144



高压油泵

YEM-H2145

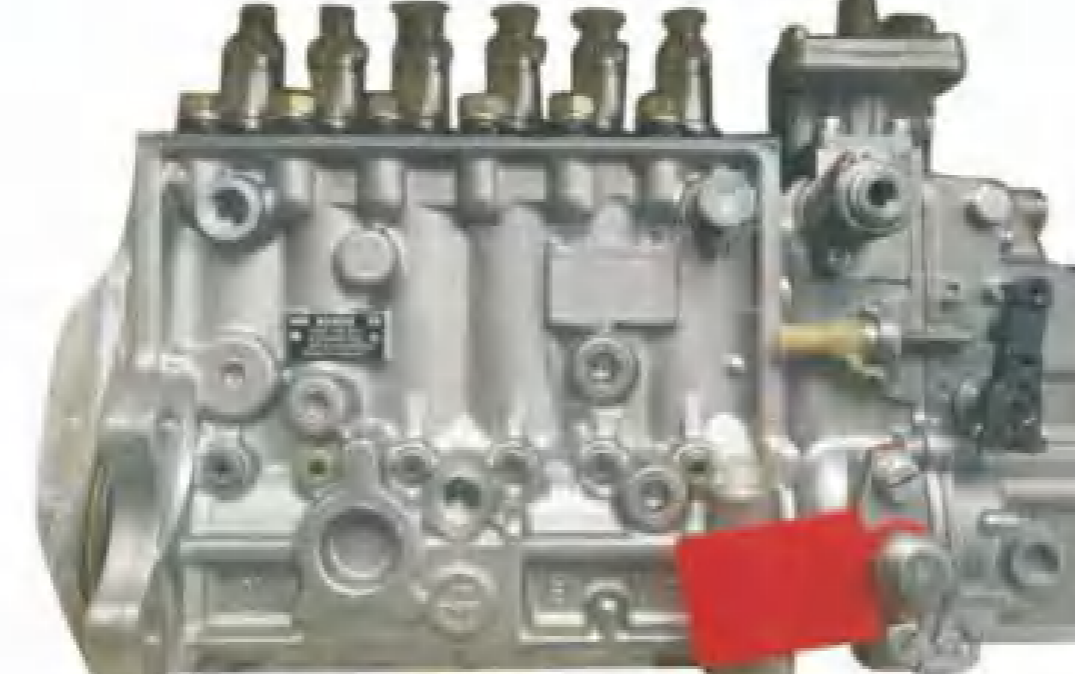

PC360-7小松 0402066729 高压油泵

YEM-H2146



PC200-7小松 高压油泵

YEM-H2147



高压油泵

YEM-H2148

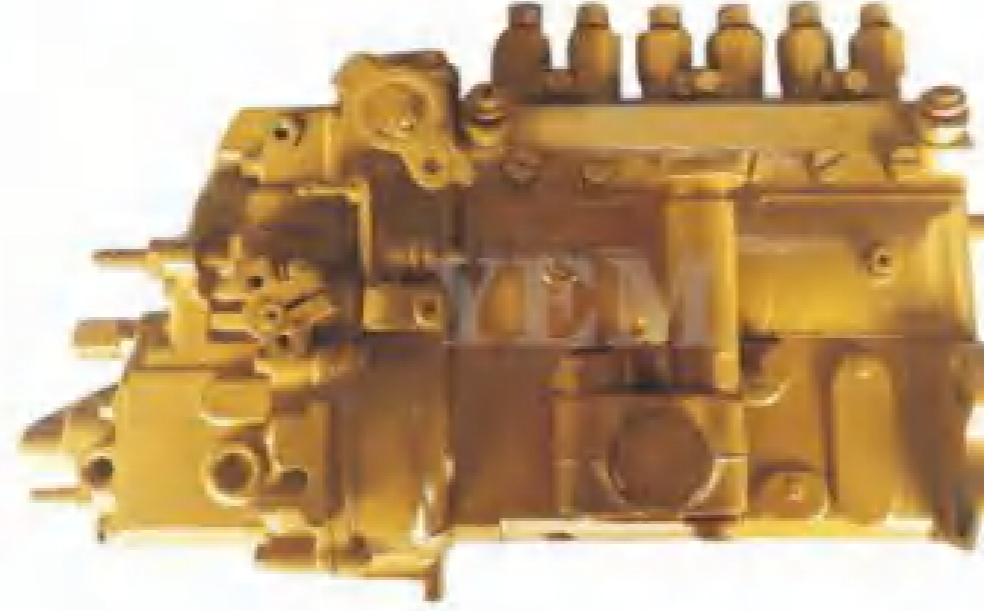

高压油泵

YEM-H2149



高压油泵

YEM-H2150



高压油泵

YEM-H2151

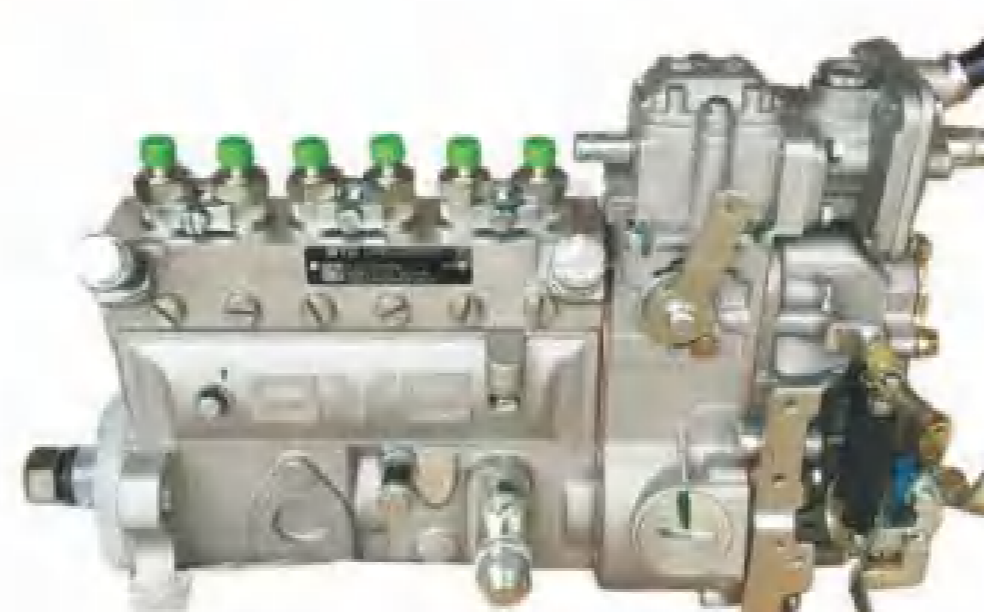

高压油泵

YEM-H2152



高压油泵

YEM-H2153



高压油泵

YEM-H2154



高压油泵

YEM-H2155



8901 5471
NOZZLE INJECTORS

YEM-H2156



6353 J05
NOZZLE INJECTORS

YEM-H2157



6593 J08
NOZZLE INJECTORS

YEM-H2158



0445120059
NOZZLE INJECTORS

YEM-H2159



0445120231
NOZZLE INJECTORS

YEM-H2160



0445120236
NOZZLE INJECTORS

YEM-H2161



VOV066
NOZZLE INJECTORS

YEM-H2162



VOV067
NOZZLE INJECTORS

YEM-H2163



09500-5215
NOZZLE INJECTORS

YEM-H2164



小松1211
NOZZLE INJECTORS

YEM-H2165



E320D 正厂
NOZZLE INJECTORS

YEM-H2166



320D国厂
NOZZLE INJECTORS

YEM-H2167



C7
NOZZLE INJECTORS

YEM-H2168



C9
NOZZLE INJECTORS

YEM-H2169



3126
NOZZLE INJECTORS

喷油嘴 NOZZLE INJECTORS

YEM-H2170



09500-5226
NOZZLE INJECTORS

YEM-H2171



E7
NOZZLE INJECTORS

YEM-H2172



VOV360
NOZZLE INJECTORS

YEM-H2173



VOV480
NOZZLE INJECTORS

YEM-H2174



003
NOZZLE INJECTORS

YEM-H2175



单体泵004
NOZZLE INJECTORS

YEM-H2176



博世005
NOZZLE INJECTORS

YEM-H2177



博世 0211 3694
NOZZLE INJECTORS

YEM-H2178



博世 0211 3695
NOZZLE INJECTORS

YEM-H2179



卡特C13
NOZZLE INJECTORS

YEM-H2180



康明斯 M11
NOZZLE INJECTORS

YEM-H2181



09500-1590
NOZZLE INJECTORS

YEM-H2182



五十铃 8-98011604-5
NOZZLE INJECTORS

YEM-H2183



NOZZLE INJECTORS

YEM-H2184



丰田 23670-OLO10/OLO50/
OLO90/OLO70
NOZZLE INJECTORS

喷油嘴 NOZZLE INJECTORS

YEM-H2185



NOZZLE INJECTORS

YEM-H2186



NOZZLE INJECTORS

YEM-H2187



NOZZLE INJECTORS

YEM-H2188



1569186
NOZZLE INJECTORS

YEM-H2189



1569195
NOZZLE INJECTORS

YEM-H2190



1569166
NOZZLE INJECTORS

YEM-H2191



1569196
NOZZLE INJECTORS

YEM-H2192



1569175
NOZZLE INJECTORS

YEM-H2193



1599195
NOZZLE INJECTORS

YEM-H2194



1569185
NOZZLE INJECTORS

YEM-H2195



NOZZLE INJECTORS

YEM-H2196



NOZZLE INJECTORS

YEM-H2197



NOZZLE INJECTORS

YEM-H2198



NOZZLE INJECTORS

YEM-H2199



NOZZLE INJECTORS

喷油嘴 NOZZLE INJECTORS

YEM-H2200  NOZZLE INJECTORS	YEM-H2201  NOZZLE INJECTORS	YEM-H2202  NOZZLE INJECTORS	YEM-H2203  NOZZLE INJECTORS	
YEM-H2204  NOZZLE INJECTORS	YEM-H2205  NOZZLE INJECTORS	YEM-H2206  NOZZLE INJECTORS	YEM-H2207  NOZZLE INJECTORS	
YEM-H2208  NOZZLE INJECTORS	YEM-H2209  NOZZLE INJECTORS	YEM-H2210  NOZZLE INJECTORS	YEM-H2211  NOZZLE INJECTORS	
YEM-H2212  NOZZLE INJECTORS	YEM-H2213  NOZZLE INJECTORS	YEM-H2214  NOZZLE INJECTORS	YEM-H2215  NOZZLE INJECTORS	
YEM-H2216  NOZZLE INJECTORS	YEM-H2217  NOZZLE INJECTORS	YEM-H2218  NOZZLE INJECTORS	YEM-H2219  NOZZLE INJECTORS	
YEM-H2220  NOZZLE INJECTORS	YEM-H2221  NOZZLE INJECTORS	YEM-H2222  NOZZLE INJECTORS	YEM-H2223  NOZZLE INJECTORS	
YEM-H2224  NOZZLE INJECTORS	YEM-H2225  NOZZLE INJECTORS	YEM-H2226  NOZZLE INJECTORS	YEM-H2227  NOZZLE INJECTORS	YEM-H2228  NOZZLE INJECTORS

喷油嘴 NOZZLE INJECTORS

YEM-H2239  卡特C-9喷油嘴	YEM-H2240  卡特320D泵出油阀	YEM-H2241  卡特320D泵出油阀	YEM-H2242  卡特C7/C9控制阀
YEM-H2243  卡特C7/C9喷油器滑阀芯组件	YEM-H2244  卡特C7/C9喷油器滑阀芯组件	YEM-H2245  卡特C7/C9喷油器滑阀芯组件	YEM-H2246  卡特C7/C9喷油器滑阀芯组件
YEM-H2247  卡特C7/C9喷油器滑阀芯组件	YEM-H2248  卡特C7/C9喷油器滑阀芯组件	YEM-H2249  卡特C7/C9喷油器滑阀芯组件	YEM-H2250  卡特C7/C9喷油器滑阀芯组件
YEM-H2251  095000-6353 DENSO REPAIR KIT	YEM-H2252  095000-6353 DENSO REPAIR KIT	YEM-H2253  下胶圈工具	YEM-H2254  电装溢流阀

YEM-H2229



001614
0445 224048
NOZZLE INJECTORS

YEM-H2230

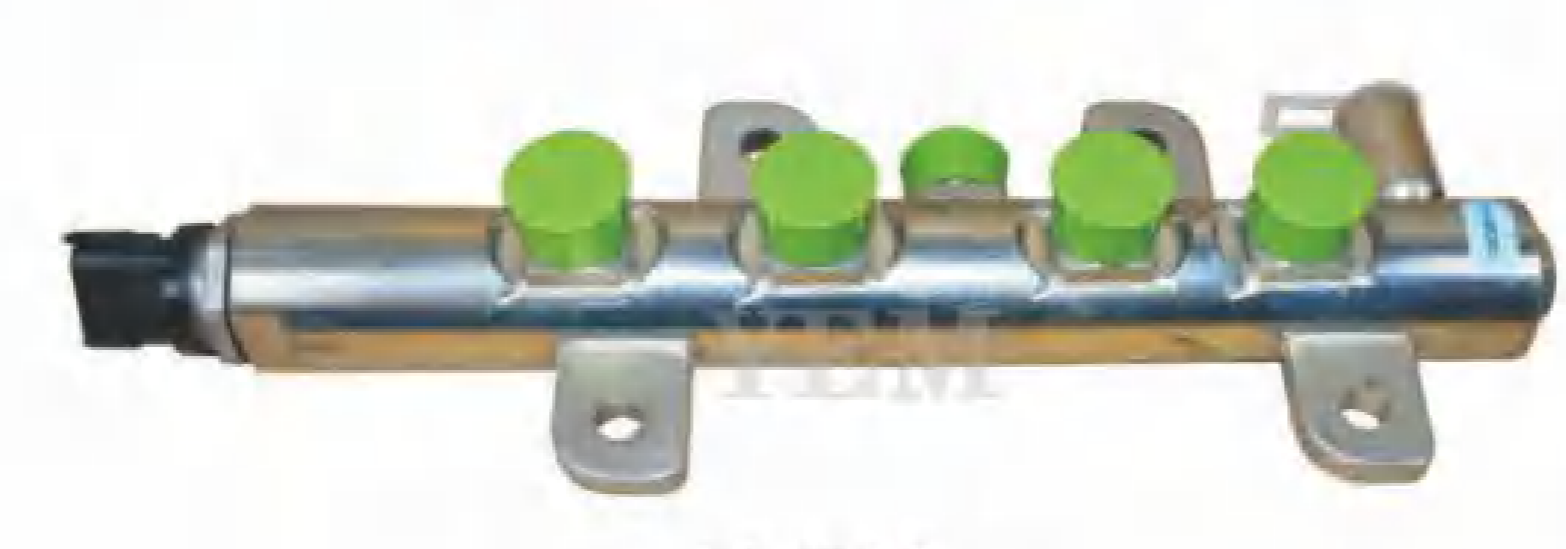

001594
04450224048
NOZZLE INJECTORS

YEM-H2231



002945
0445 226 042
NOZZLE INJECTORS

YEM-H2232



NOZZLE INJECTORS

YEM-H2233



高压共轨器

YEM-H2234



高压共轨器

YEM-H2235



高压共轨器

YEM-H2236



高压共轨器

YEM-H2237



高压共轨器

YEM-H2238



高压共轨器

YEM-H2255



Retaining Nut Nozzle

YEM-H2256



Retaining Nut Nozzle

YEM-H2257



Nt855 3011934
喷油嘴铜套
Retaining Nut Nozzle

YEM-H2258



6D125 铜套
喷油嘴铜套
Retaining Nut Nozzle

YEM-H2259



H07CT 11176-1022
喷油嘴铜套
Retaining Nut Nozzle

YEM-H2260



H06/7D 11176-1120
喷油嘴铜套
Retaining Nut Nozzle

YEM-H2261



PC200-3
喷油嘴铜套
Retaining Nut Nozzle

YEM-H2262



6D14 6D15 ME-030855
喷油嘴铜套
Retaining Nut Nozzle

YEM-H2263



6D22 6D20
喷油嘴铜套
Retaining Nut Nozzle

YEM-H2264



Nh220 202605
喷油嘴铜套
Retaining Nut Nozzle

YEM-H2265



4HK1 6HK1
电喷喷油嘴铜套
Retaining Nut Nozzle

YEM-H2266



4HK1 6HK1
直喷喷油嘴铜套
Retaining Nut Nozzle

YEM-H2267



J08C
N481-11176-1190
喷油嘴铜套
Retaining Nut Nozzle

YEM-H2268



K13C
喷油嘴铜套
Retaining Nut Nozzle

YEM-H2269



1193061
喷油嘴铜套
Retaining Nut Nozzle

YEM-H2270



S6D155
喷油嘴铜套
Retaining Nut Nozzle

YEM-H2271



VOLVO276811A
喷油嘴铜套
Retaining Nut Nozzle

YEM-H2272



VOLVO3183368
喷油嘴铜套
Retaining Nut Nozzle

YEM-H2273



VOLVO276130
喷油嘴铜套
Retaining Nut Nozzle

YEM-H2274



VOLVO270946
喷油嘴铜套
Retaining Nut Nozzle

YEM-H2275



D2366
喷油嘴铜套
Retaining Nut Nozzle

YEM-H2276



8DC9
喷油嘴铜套
Retaining Nut Nozzle

YEM-H2277



C9 227-1200
喷油嘴铜套
Retaining Nut Nozzle

YEM-H2278



FD33 N480-1170-25504
喷油嘴铜套
Retaining Nut Nozzle

YEM-H2279



E13C 喷油嘴铜套
Retaining Nut Nozzle

YEM-H2280



1110010015博世潍柴卸压阀

YEM-H2281



1110010017卸压阀

YEM-H2282



1110010022卸压阀

YEM-H2283



1110010024卸压阀

YEM-H2284



1110010027卸压阀

YEM-H2285



1110010028博世卸压阀

YEM-H2286



1110010008卸压阀

YEM-H2287



1110010020康明斯卸压阀

YEM-H2288



1110010021卸压阀

YEM-H2289



1110010035康明斯卸压阀

YEM-H2290



FOOR000756康明斯卸压阀

YEM-H2291



FOOR000775康明斯卸压阀

YEM-H2292



电装0260(01369)卸压阀

YEM-H2293



五十铃限压阀
8-98032549-0

YEM-H2294



力士乐清洗阀

YEM-H2295



EGR冷却器废气阀通管
4JB1

YEM-H2296



EGR冷却器废气阀通管
4HK1

YEM-H2297



EGR冷却器废气阀通管
6HK1

YEM-H2298



EGR冷却器废气阀通管
J08

YEM-H2299



EGR冷却器废气阀通管
J05



YEM-H2300



SK460-8/P11C/EGR



J08/EGR



J05/EGR



6WG1/EGR

YEM-H2301



SK75-8/EGR



6D125/EGR主体



6D125中连接管



6D125后连接管

增压器进油管

SUPERCHARGER INLET PIPE



增压器回油管

SUPERCHARGER RETURN PIPE



喷油嘴回油管 NOZZLE RETURN PIPE

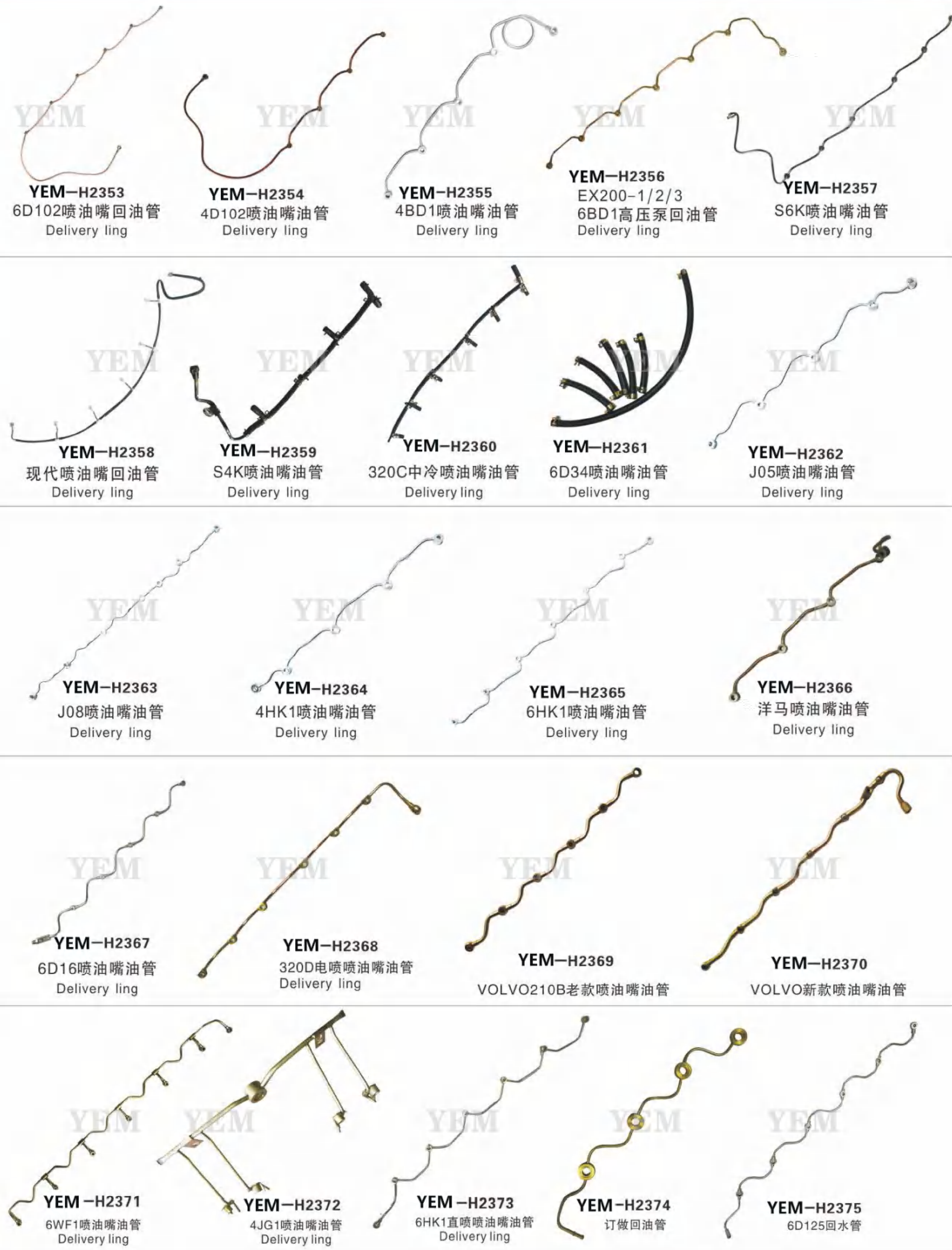

各类油管 ALL KINDS OF TUBING



高压油管 NOZZLE PIPING

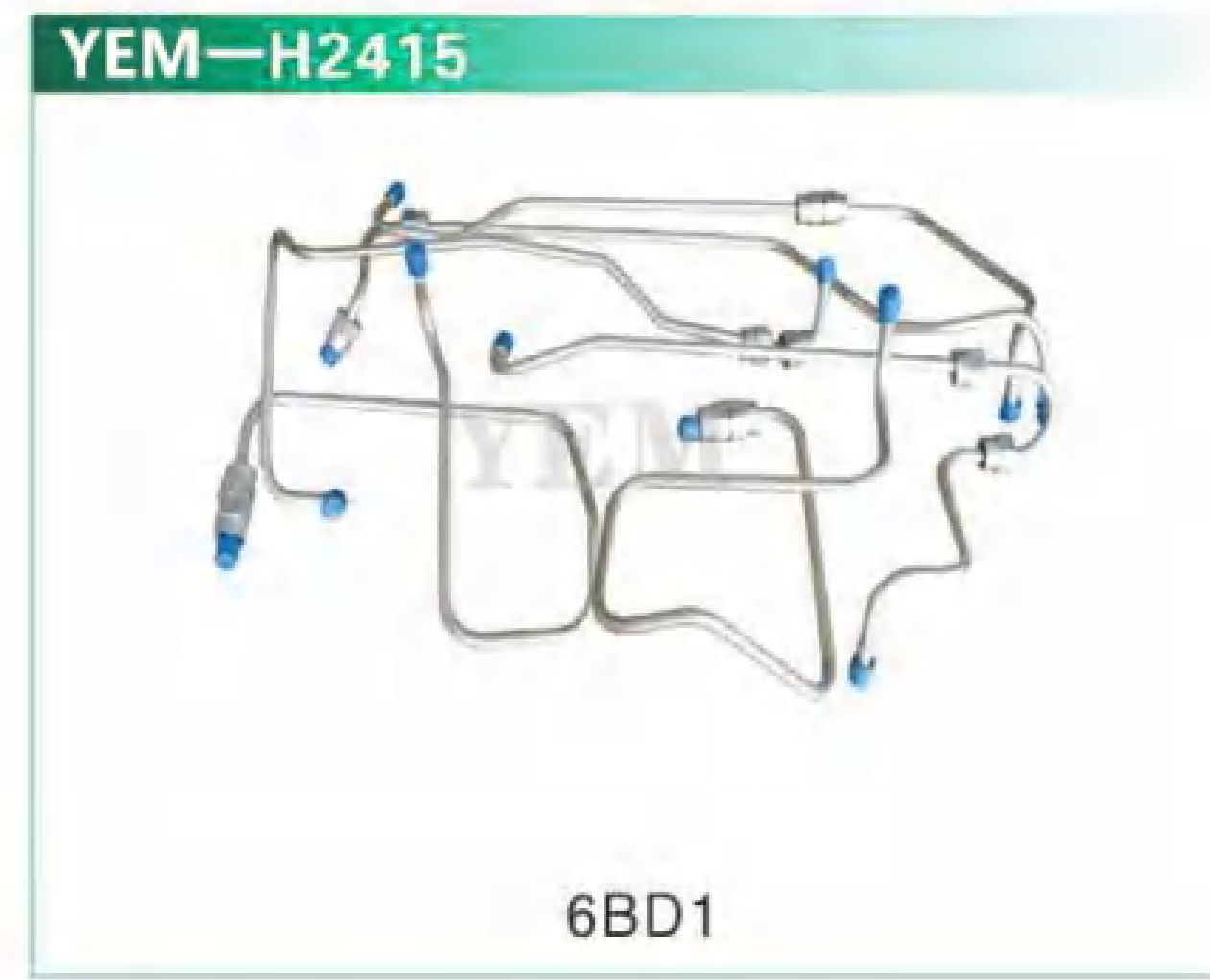
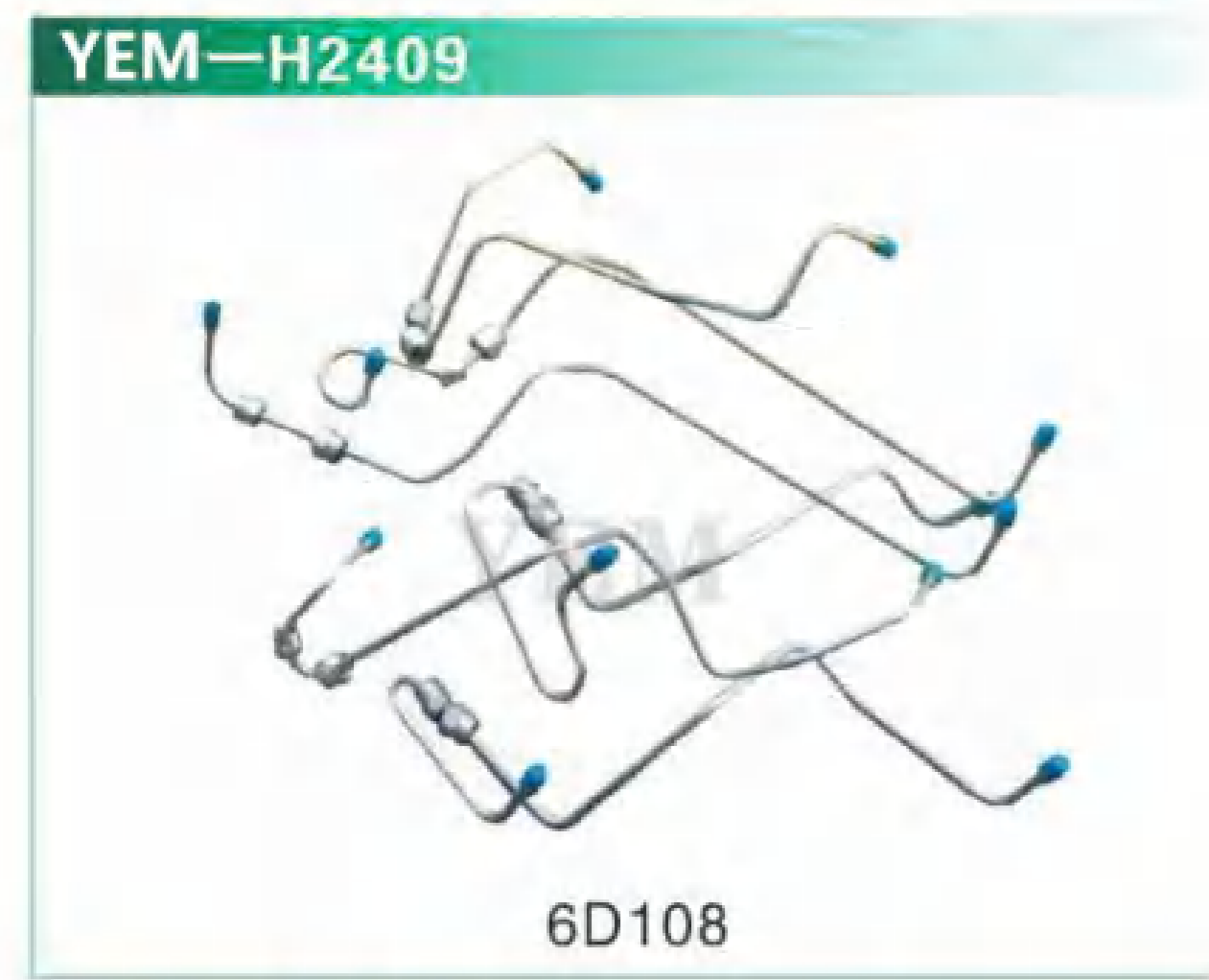
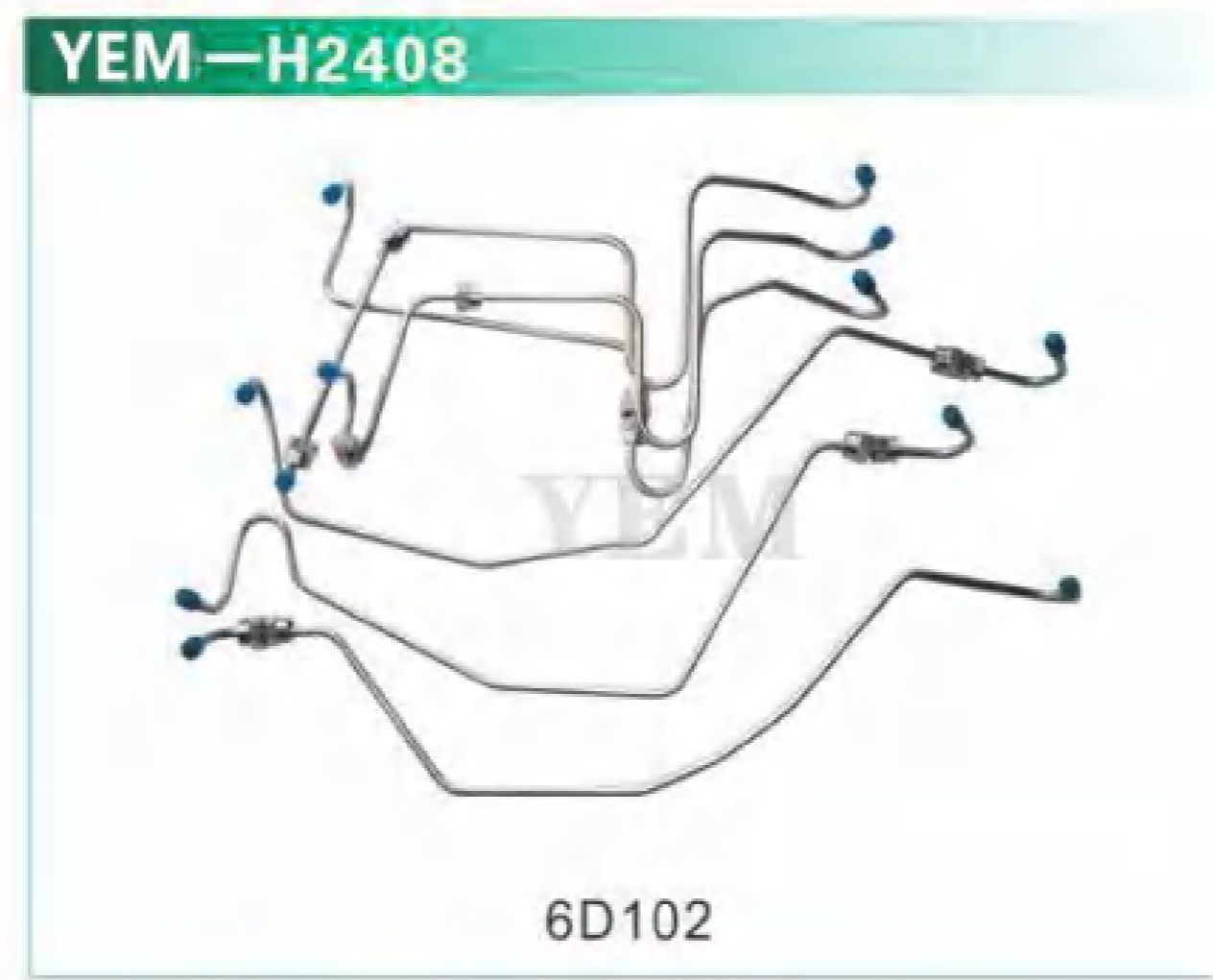
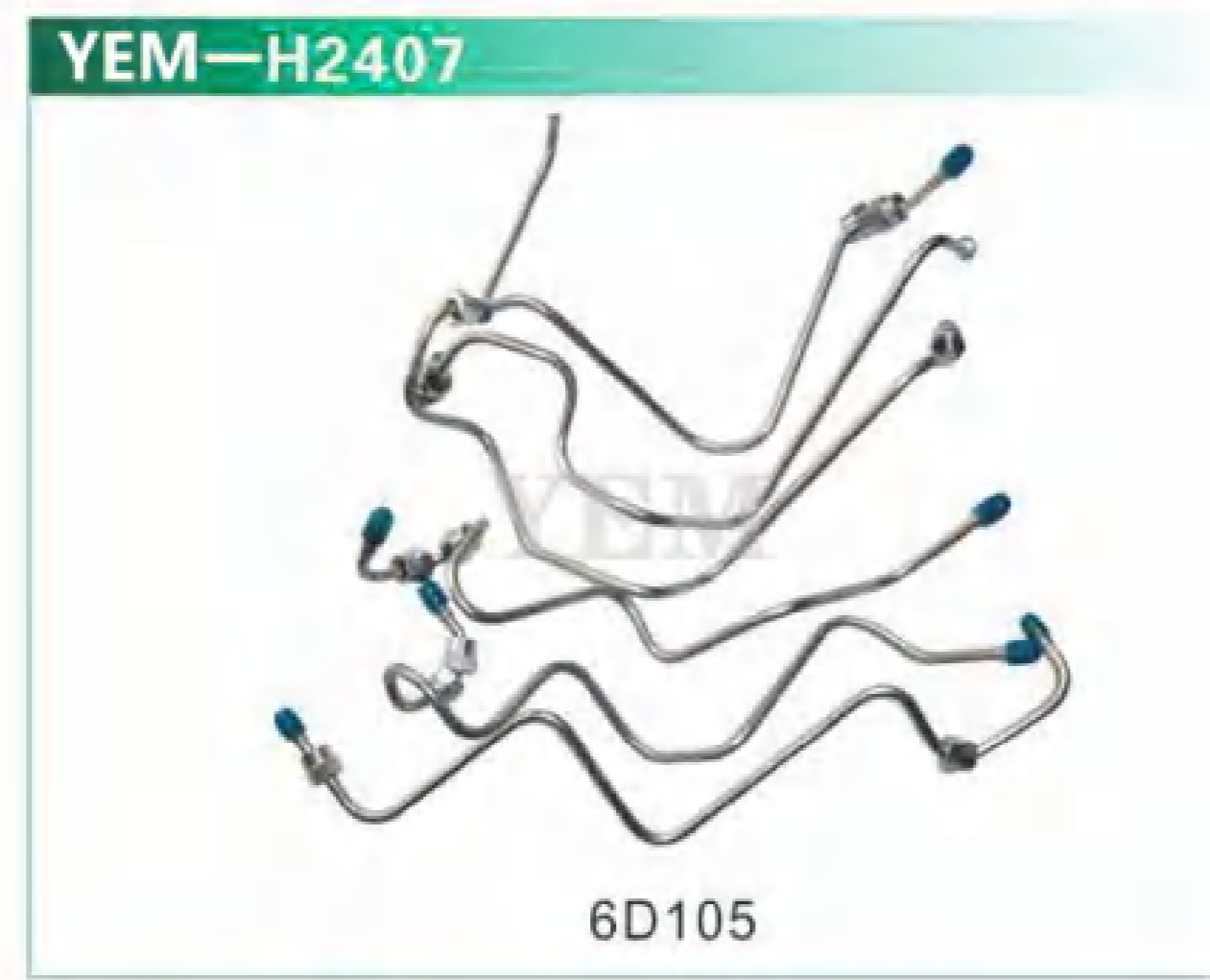
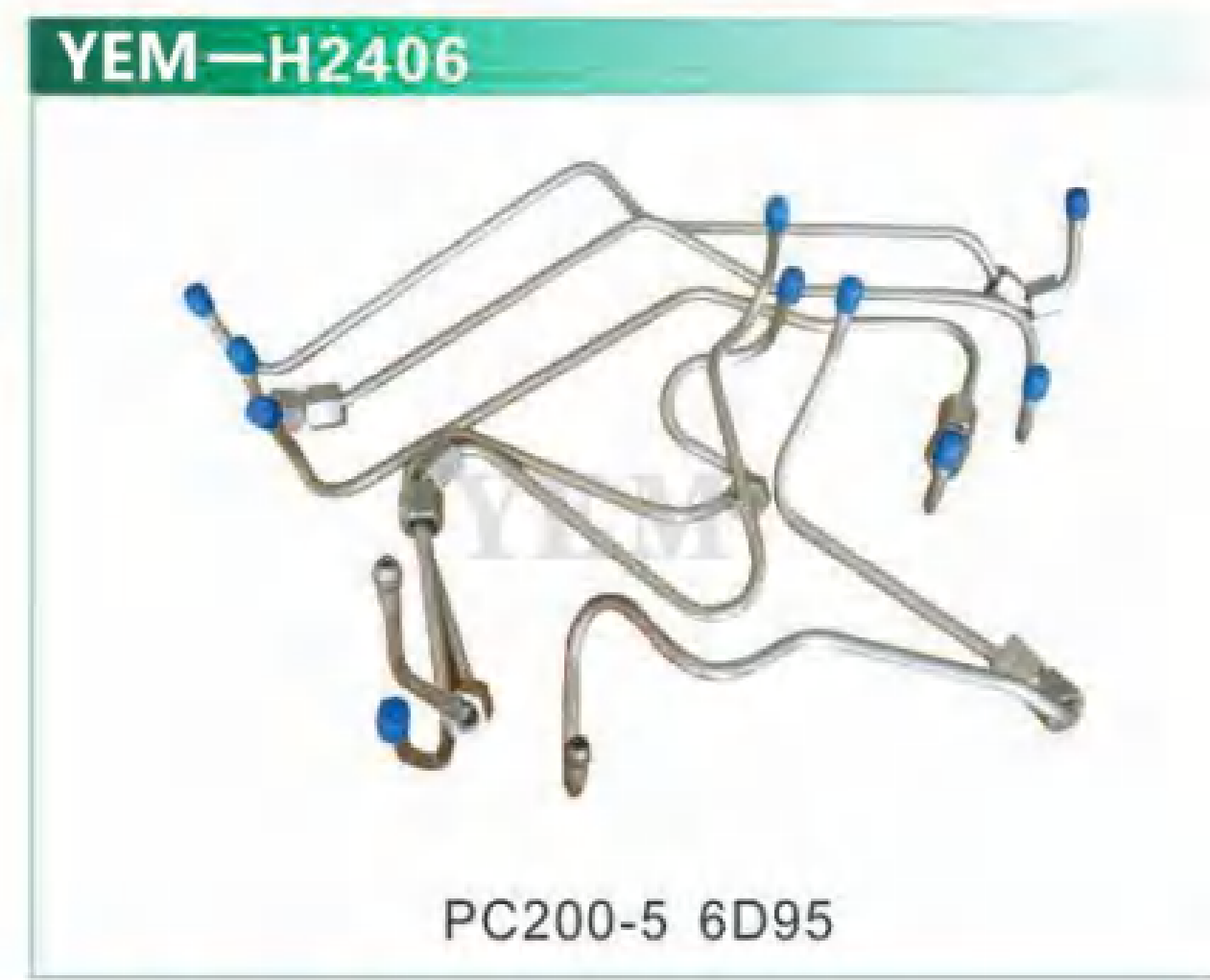

高压油管 NOZZLE PIPING

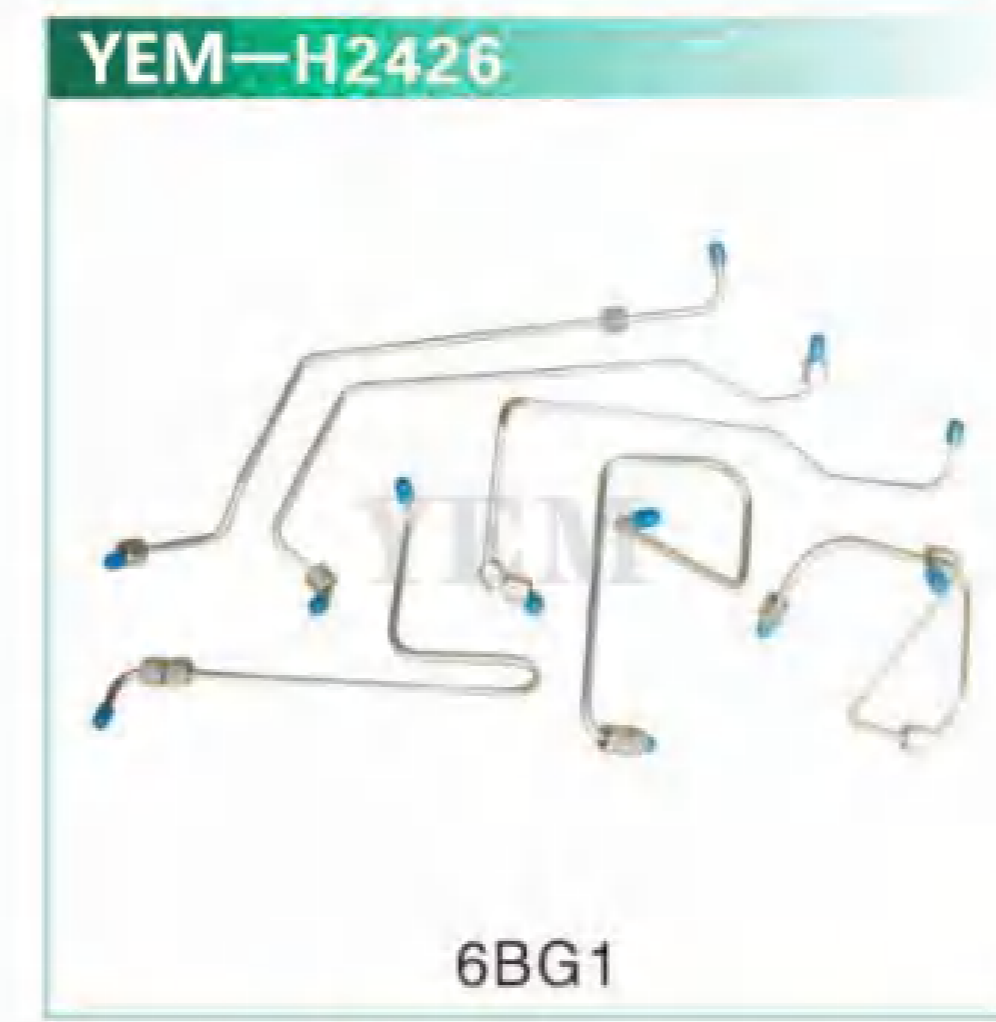

KOMATSU

YEM-H2438



PC60-6/4D95
24V/9T/3.8KW
600-813-4411

YEM-H2439



PC60-7/6D95(NEW)
24V/11T/4.5KW
600-813-4400

YEM-H2440



PC200-5/6/6D95
24V/3FL/10T/6KW
600-813-4412

YEM-H2441



PC200-6/7 6D102
24V/2FL/10T/5.5KW
600-813-5110

YEM-H2442



6D102 电装
24V/2FL/10T/4.5KW
600-63-4110

YEM-H2443



6D102 (ND)
24V/10T/3FL

YEM-H2444



PC200-3 6D105
24V/3FL/13T/6KW
600-813-4120

YEM-H2445



PC300-5/6 6D108
24V/3FL/2T/7.5KW

YEM-H2446



PC300 PC400 6D125
24V/3FL/12T/7.5KW
600-813-4530
600-813-4670 ME152487

YEM-H2447



PC360-7/6D114
24V/12T

YEM-H2448



6D155
24V/11T

YEM-H2449



4D130
24V/11T/7.5KW

YEM-H2450



4D31 MTSUBISHI
9T/3FL/3.2KW
M2T64272 ME017004

YEM-H2451



4D31-14T MTSUBISHI
24V/14T/3.2KW
ME152487

YEM-H2452



4D33
24V/9T

YEM-H2453



4D31/4D32
MTSUBISHI
24V/13T/5.0KW

YEM-H2454



6D14/15/16 SK250 SK200-5
24V/11T/5.5KW
ME077408

YEM-H2455



6D17
24V/2FL/11T/6.0KW

YEM-H2456



6D22
24V/11T/4.5KW
ME057200

YEM-H2457



6D24
24V/3FL/11T/6.0KW

YEM-H2458



6D31 SK200 HD700-5
24V/2FL/11T/5.5KW
ME087590

YEM-H2459



S4Q S4Q-2
12V/2FL/10T/2.5KW

YEM-H2460



6D34 SK230-6
24V/11T/5.5KW

YEM-H2461



4D34

YEM-H2462



D4BB

YEM-H2463



S4F MTSUBISHI
12V/10T/3.2KW
OEM:34466-10103

YEM-H2464



奥兰 MTSUBISHI
24V/10T/3.5KW
M2T65971

YEM-H2465



8DC8/8DC9/8DC10(413)
MTSUBISHI
24V/13T/7.0KW

YEM-H2466



4DR5/4DR7/4D31
MTSUBISHI
12V/9T/2.2KW

YEM-H2467



S4K S6K E120 E200B
24V/2FL/10T/5.5KW
M3T51682

YEM-H2468



S6E
24V/2FL/10T/5.5KW

YEM-H2469



E320B/C
24V/10T/3.2KW
32B66-0102

MTSUBISHI

MTSUBISHI

CAT ERPILLAR

ISUZU GENUINE

起动马达 STARTING MOTOR

起动马达 STARTING MOTOR

ISUZU GENUINE

YEM-H2478



6SD1 EX300
6SA1MSA1MTC
24V/11T

YEM-H2479



6SD1(ND) EX300
6SA1MSA1MTC
24V/11T

YEM-H2480



6HH1/6HK1 SUZUKI
24V/2孔/11T/5.0KW

YEM-H2481



4HF1 SUZUKI
24V/2孔/11T/4.0KW

YEM-H2482



4BD1
24V/9T/3.8KW
94333438-5

YEM-H2483



6WG1/6WA1 SUZUKI
24V/3孔/11T/8.0KW

YEM-H2484



4JB1 (24V)
12V/9T/3.5KW
OEM:8-94423-452-0

YEM-H2485



DH55/4JG1 (24V)
12V/11T/3.5KW

DOOSAN

YEM-H2486



DH370
3孔/11T

YEM-H2487



DH200-5
ZAX200-6 210/230/240
3孔/11T

YEM-H2488



DH280-3
9T/3孔/24V/6.6KW
6526201-7058

YEM-H2489



DH300-5/220-3
24V/11T/4.5KW

CUMMINS

YEM-H2490



CUMMINS 6CT
24V/12T/7.5KW

YEM-H2491



CUMMINS 6CT
24V/12T/8.0KW

YEM-H2492



NT855
24V/3孔/11T/7.5KW

YEM-H2493



50MT
24V/11T

YEM-H2494



37MT

YEM-H2495



CUMMINS 6BT5.9(ND)
24V/10T/4.8KW

YEM-H2496



CUMMINS 4B3.3
12V/9T/2.8KW

YEM-H2497



CUMMINS 4B3.9
12V/13T/2.8KW

CUMMINS

YEM-H2498



6CT(反方向) CUMMINS
24V/12T/7.5KW

YEM-H2499



雷诺卡车
M9T60671
24V/12T/5.5KW

YEM-H2500



Cummins ISM 11.0L
Cummins ISX 15.0L Engines
24V/11T/8.0KW

YEM-H2501



Cummins ISC 8.3L
24V/12T/8.0KW

YEM-H2502



FM9/D9 VOLVO
24V/11T/5.5KW

YEM-H2503



FM12/FH12/V300
VOLVO360
6CT CUMMINS
24V/12T/5.5KW

YEM-H2504



210/240/290 VOLVO
24V/12T/5.5KW

YEM-H2505



BOSCH
VOLVO 210 240
24V/9T

VOLVO

YEM-H2506



尼桑 PC6
24V/3孔/11T/6.0KW

YEM-H2507



尼桑 PE6
24V/3孔/11T/4.5KW

YEM-H2508



尼桑 RD8 RE8
24V/3孔/11T/7.5KW

NISSAN

YEM-H2509



尼桑 TD42
24V/3孔/11T/5.0KW

YEM-H2510



尼桑 PD46T
24V/3孔/11T/4.5KW

YEM-H2511



尼桑 PD46T
24V/3孔/11T/7.5KW

YEM-H2512



日野 EK100
24V/3孔/11T/7.0KW

YEM-H2513



日野 EM100
24V/3孔/11T/7.0KW

YEM-H2514



HINO 07C
24V/11T/4.5KW

HINO

起动马达 STARTING MOTOR

起动马达 STARTING MOTOR

HINO

YEM-H2515



P11C SK450-8

YEM-H2516



HINO J05/J08C
24V/11T/4.5KW

YEM-H2517



HINO S05C
24V/11T/4.5KW

YEM-H2518



HINO EH700 H06CT
24V/11T/5.0KW

YANMAR

YEM-H2519



YANMAR 4D94-电装款
9T

YEM-H2520



YANMAR 4T98
24V/9T

YEM-H2521



YANMAR 4D84
15T/PC40

YEM-H2522



4T9V94 原装款 9T

YEM-H2523



4D84 13T

YEM-H2524



YANMAR
12V/11T

YEM-H2525



KUBOTA 久保田
12V/9T/2.0KW

YEM-H2526



久保田 V3008/V3300
12V/9T/2.5KW

OTHERS

YEM-H2527



底特律/普雷沃斯特
24V/11T/7.5KW

YEM-H2528



CHEV/GMC 6.2L&6.5L
12V/10T/2.5KW

YEM-H2529



Military Equipment W/6.2L GM
24V/10T/3.8KW

YEM-H2530



Bobcat/clark/john Deere
Farm & Industrial Equipment
12V/10T/2.9KW

YEM-H2531



Consolidated/Cummins/
Dressem/Timberjack
24V/10T/3.8KW

YEM-H2532



Bobcat/Consolidated/Freightliner
White Farm Equipment
W/Cummins 3.9I/5.9
12V/10T/2.9KW

YEM-H2533



Allis-chalmers/Bobcat/Clark/
Cummins 3.9I Perkins
12V/12T/2.9KW

YEM-H2534



Bobcat/Clark/DeutzFord New Holland/
Massey Ferguson/Perkins
12V/10T/2.9KW

YEM-H2535



Bobcat/Clark SKID STEER LOADER
W/KUBOTA V2203E
12V/12T/2.9KW

YEM-H2536



HYSTER LIFT TRUCKS
W/PERKINS 6-354
12V/10T/2.9KW

YEM-H2537



Ford Truck5 W/Cummins 5.9L or
FD-1060/wo/Allison AT
12V/10T/2.9KW

YEM-H2538



Mercedes
12V/9T/3.5KW

YEM-H2539



Mercedes-Benz Om541
24V/12T/7.5KW

YEM-H2540



Freightliner/sterling Western
Star w/Mercedes-MBE 4000
12.8L Engines
12V/12T/7.2KW

YEM-H2541



Used On:
Mark Truck/Mercedes-Benz Truck
12V/11T/7.5KW

YEM-H2542



Dodge Ram Pickup 5.9L
Diesel Engine
12V/13T/2.5KW

YEM-H2543



Case w/Case 188Engine
Case Crawler/Loader
12V/13T/2.5KW

YEM-H2544



Case Ford/Versatile Loaders/
Tractors/Cummins 3.9L 5.9L
Diesel Engine
12V/13T/2.5KW

YEM-H2545



Dodge D/W Series Pickup 5.9L
Diesel Engine
12V/13T/3.5KW

YEM-H2546



Ford E8tf-11000-aa/E8tf-11002-a
Ford E/f Series Van/pickup 6.9I-7.3I
Ford V8(1985-1988)pickup
12V/13T/2.4KW

YEM-H2547



FORD F4TZ-11002-A
F5TU-11000-AA/F5TU-11000-AB
12V/12T/3.0KW

YEM-H2548



FORD F4TZ-11002-B
FORD E Series V8 7.3L
F Series Pickup V8 7.3L
12V/12T/3.0KW

YEM-H2549



GMC Sierra 6.6L (2006-01)
Chevrolet Silverado
GMC Sierra 6.6L(Diesel)
Chevrolet Kodiak/GMC Topkick
Trucks 6.6L(Diesel) 12V/9T/2.8KW

OTHERS

发电机 ALTERNATOR

发电机 ALTERNATOR

YEM-H2550



型号: PC60 4D95
件号: 600-821-3850
0-33000-5510 24V 15A

YEM-H2551



型号: PC200-3/5 6D1051PK
件号: 600-821-6120
0-33000-5860

YEM-H2552



型号: PC200-60 6D95 8PK/4D102
件号: 600-821-6190
0-33000-6580 24V 25A

YEM-H2553



型号: PC200-7
件号: 24V 60A

YEM-H2570



型号: 3306 CAT OLD TYPE
件号: 6N9294
24V 45A

YEM-H2571



DH55 4JB1
897228-3180 5-37813253
-0 99723442 12V 50A

YEM-H2572



27SI CUMMINS Dt008

YEM-H2573



MT322 6D22
0-33000-6511

YEM-H2554



型号: PC200-6 S6D102
件号: 600-861-3411/6410
101-211-4310 24V 25A

YEM-H2555



型号: PC300 6D125
件号: 24V 25A
600-311-5720/0-33000-5880

YEM-H2556



型号: PC300-7 PC300-6 6D108
件号: 24V 600-821-6160/0-33000-6511

YEM-H2557



型号: PC HT20-2 D60推土机 S4D120
件号: 600-821-3350 24V 25A

YEM-H2574



6D34T

YEM-H2575



SK120 4B01

YEM-H2576



SK200-6 SK230-6 6D34
24V 35V ME08887
A3TN5399

YEM-H2577



R210-5 MITSUBISHI D6BR

YEM-H2558



型号: EX200-1 24V 25V
件号: 1-81200-365-2 0-33000-6000

YEM-H2559



型号: EX200-2 6BD1/住友200
件号: 24V 30A 1-81200-440
-2/0-33000-6552 9218005

YEM-H2560



型号: EX200-3

YEM-H2561



型号: EX200-5 6BG1
件号: 24V 40A 1-81200-471
-0/0-35000-3872

YEM-H2578



4M40

YEM-H2579



4D31

YEM-H2580



HD250/HD450 4D31

YEM-H2581



VOLVO 210

YEM-H2562



型号: ZAX230/240 3PK
件号: 4HK1

YEM-H2563



型号: ZAX330 6HK1

YEM-H2564



EX55 4LE1

YEM-H2565



型号: ZAX200-6 6BG1
件号: 24V 50A

YEM-H2582



VOLVO 旧款

YEM-H2583



J08 J05

YEM-H2584



型号: R60-5/R60-6/R55

YEM-H2585



型号: R60-7
件号: 119626-77210

YEM-H2566



DH220-5

YEM-H2567



型号: E200B E320 6D31 6D14

YEM-H2568



型号: E320B/E320C
件号: 34368-01100 A4T6686
24V 35A

YEM-H2569



型号: E320D/E320C
件号: 12PK

YEM-H2586



H06CT

YEM-H2587



CASE 0120-488-205 12V 55V

YEM-H2588



DH220-3 DH002
ME070120 A2T72986
24V 30A

YEM-H2589



























HH750 H1N0

增压器 TURBOCHARGER

YEM-H2590  康明斯系列 H1C 4BT	YEM-H2591  康明斯系列 H1E 6CT	YEM-H2592  康明斯系列 WH1E-1 6CT	YEM-H2593  康明斯系列 HX40W 6BT	YEM-H2594  康明斯系列 HX40W 6D114
YEM-H2595  康明斯系列 H2D LT-10	YEM-H2596  康明斯系列 Hx55 M11	YEM-H2597  康明斯系列 T-46 NT855	YEM-H2598  康明斯系列 H25A K19	YEM-H2599  康明斯系列 Hx80 K38
YEM-H2600  康明斯系列 K50 K19	YEM-H2601  康明斯系列 Ht60 M4	YEM-H2602  小松系列 KTR110 S6D140	YEM-H2603  小松系列 KTR110 S6D170	YEM-H2604  小松系列 TA4532 S6D125
YEM-H2605  小松系列 S400 S6D125E-3	YEM-H2606  小松系列 T04B53 S6D105	YEM-H2607  小松系列 T04B59 S6D95	YEM-H2608  小松系列 T04E S6D108	YEM-H2609  小松系列 TB4130 S6D125
YEM-H2610  小松系列 TA3103 S4D95	YEM-H2611  小松系列 TA3137 S4D95	YEM-H2612  小松系列 HX35W S6D102E	YEM-H2613  小松系列 TD04-L-106 4BT	YEM-H2614  小松系列 HX30 S6D95

增压器 TURBOCHARGER

YEM-H2615  小松系列 HX35 S6D102E	YEM-H2616  小松系列 HX30W 4BT	YEM-H2617  小松系列 KTR130 D155	YEM-H2618  卡特系列 T04B91 3304	YEM-H2619  卡特系列 TD06H-16M S6K
YEM-H2620  卡特系列 TD06H-16M 3066	YEM-H2621  卡特系列 133745 3116	YEM-H2622  卡特系列 3LM373 3306	YEM-H2623  卡特系列 S310 3306	YEM-H2624  卡特系列 E325C 3116
YEM-H2625  卡特 3306	YEM-H2626  卡特系列 CAT330 3306	YEM-H2627  卡特系列 3406B	YEM-H2628  卡特系列 3406	YEM-H2629  卡特系列 S310E-080 C-9
YEM-H2630  卡特系列 D7G 3306	YEM-H2631  卡特系列	YEM-H2632  卡特系列 D345B	YEM-H2633  大宇系列 DH300-7	YEM-H2634  大宇系列 DH300-5 D1146
YEM-H2635  沃尔沃系列 S2B-2 210	YEM-H2636  日野系列 EX220-5 H07CT	YEM-H2637  日野系列 EX220-5 H07CT	YEM-H2638  日野系列 TBP430 J08C	YEM-H2639  日野系列 TBP430 J08C

增压器 TURBOCHARGER

YEM-H2640  日野系列 HX50W K13D	YEM-H2641  日野系列 Gt3576 J08E	YEM-H2642  日野系列 RHE8 K13C	YEM-H2643  日野系列 RHE9 6WGF1	YEM-H2644  日野系列 RHC6 T04E
YEM-H2645  日野系列	YEM-H2646  三菱系列 Td04 4D56	YEM-H2647  三菱系列 S1B	YEM-H2648  三菱系列 S6A	YEM-H2649  尼桑系列 Pd6 KLD85Z
YEM-H2650  尼桑系列 FD46	YEM-H2651  尼桑系列 Qd32	YEM-H2652  住友系列 4BD1 S120	YEM-H2653  住友系列 S280 6BD1	YEM-H2654  加藤系列 RHE6 6BG1
YEM-H2655  加藤系列 TD05-10A HD512	YEM-H2656  加藤系列 Td06 HD450	YEM-H2657  加藤系列 TD06-17A HD700	YEM-H2658  加藤系列 TD07-17C HD700-5	YEM-H2659  加藤系列 TD08H HD850
YEM-H2660  加藤系列 TD07-9 6D14	YEM-H2661  日立系列 RHB6 4BD1	YEM-H2662  日立系列 RHC7 6BD1	YEM-H2663  日立系列 ZAX330 6HK1	YEM-H2664  日立系列 RHC9 6WG1

增压器 TURBOCHARGER

YEM-H2665  日立系列 RHC9 6BD1	YEM-H2666  日立系列4HK1 J05E	YEM-H2667  日立系列 RHC6 6BD1	YEM-H2668  日立系列 RHE61 6BG1	YEM-H2669  日立系列 RHC7 6SD1
YEM-H2670  日立系列 RHEC 6SD1	YEM-H2671  日立系列 TD08H EX300-5	YEM-H2672  日立系列 Ta5108 6RB1	YEM-H2673  现代系列 GT-17	YEM-H2674  现代系列HX35W R2205
YEM-H2675  现代系列TD04H-16	YEM-H2676  现代系列GT17	YEM-H2677  现代系列HX35	YEM-H2678  现代系列 瑞丰	YEM-H2679  现代系列GT17
YEM-H2680  现代系列GT1749S 4D56	YEM-H2681  现代系列HX40W D1146	YEM-H2682  丰田系列 Ct19 HR492HT	YEM-H2683  丰田系列 CT12B 3-G-3202	YEM-H2684  丰田系列 Ct20 HR492HT
YEM-H2685  神钢系列 Td041 4BD1	YEM-H2686  神钢系列 TD06H-13M 6D34	YEM-H2687  神钢系列 TD06H-16M 6D34	YEM-H2688  神钢系列 SK200-8 J05E	YEM-H2689  神钢系列 SK350-8 J08E

增压器 TURBOCHARGER

小松 Komatsu		
Turbo Model	Engine Model	Part No
PC60	S6D95	
PC100-1/2/3/5	S4D95	6205-81-8110
PC100-6	S4D95	
PC120-1/2/3/5	S4D95	6732-81-8102 3539803 3539846 3804963
PC120-6	S4D102	6732-81-8100
PC130-7	SAA4D95LE-3	6208-81-8100
Pc150	S6D95	
PC200-3	S6D105	6137-82-8200
PC200-5	S6D95	6207-81-8210
PC200-6	S6D95	6207-81-8311
PC220-6	S6D102	6735-81-8031/8500 3539697 3539698 3539699 3539700
PC200-7	SAA6D102E-2	6738-81-8090 4038475 4035373 4035374 4035172
PC210-7	SAA6D102E-2	
PC220-7	SAA6D102E-2	6738-81-8181/8190 3598036 4035899 4038471 4035376
PC200-8	SAA6D107E-1	
PC210-8	SAA6D107E-1	
PC220-8	SAA6D107E-1	
PC240-8	SAA6D107E-1	
PC300	S6D125	6152-81-8110
PC300-5/6	S6D108	6222-81-8210 6222-83-8171
PC300-7	S6D114	6743-81-8040/4038421 3597311/2 3597808 3597809/10/11
PC360-7	SAA6D114	
PC400	S6D125	6152-81-8500
PC400-5	S6D125	6152-81-8210
PC400-6	S6D125E	6152-82-8210
PC400-7	SA6D125E-3	
PC450-7	SA6D125E-3	
PC1000	6D170	6505-11-6250
D155	S6D155	6502-13-2003
D355	S6D155	6502-12-9005
KTR110	S6D140	6505-52-5410
KTR110	S6D170	6505-52-5540
D85	NT855	
WA320-3	S6D108	6222-83-8120
WA320-3	SA6D102E	6736-81-8190
WA350-1	S6D110-1A	6138-82-8201
WA380-1	S6D110-1Q	6138-82-8200
WA380-3	S6D108-1F	6222-83-818
WA380-3	SA6D114	6742-01-3110
WA380-5	S6D114-2B	6743-81-8050
WA400-1	S6D110-1J	6138-82-8201
WA420-1	S6D110-1W	6138-82-8200
WA420-3	S6D114	6742-01-5000
WA450-1	S6D125-1M	6152-81-8300

WA470-1	S6D125-1KK	6152-81-8310
WA470-3	S6D125-1AM	6152-81-8310
WA470-3	S6D125E-2	6152-81-8310
WA500-1	S6D140-1	6505-11-6474
	S6D170-1D	6505-52-5510
	SA6D170A-1Q	6162-84-8201
日立 HITACHI		
Turbo Model	Engine Model	Part No
RHB6	4BD1	8-94418-3200
TDO4	4BD1	49189-00540
TDO4	4BG1	49189-00501
EX200-1	6BD1	114400-2100
EX200-2/3	6BD1	114400-2720
EX200-5	6BG1	114400-3320
EX200-6	6BG1	114400-3770
EX220-1	HO6CT	24100-1860
EX220-5	HO7CT	24100-3340
EX220-5		24100-2252B
EX300-1	EP100	24100-1440
EX300-2/3	6SD1	114400-2961
EX300-3C	6SD1TPD-S	114400-3340
EX300-5/330-5	6SD1TQA	114400-3530
ZAX200	6BG1	114400-3770
ZAX330	6HK1	114400-3900
EX300-7	6HK1	
EX400-1	6RB1	114400-2080
EX400-3	6RB1	114400-3170
EX450-5	6RB1	114400-3360
ZAX330-3C	6SD1	114400-4380
ZAX240-3	4HK1	8973628390
ZAX250	4HK1	8973628390
ZAX450	6RB1	114400-3830
FE6	RHC6	210690 1420125613
卡特 CAT		
Turbo Model	Engine Model	Part No
E110	4D31	517585
E110B	S4K	517903
E120	6D14	517903
E120B	S4K	49168-00330
CAT225	3304	4N6858
E240	6D15	518122
E240B	3116	49168-01202
E200B	S6K	49179-00451 515015
E312B	S4K	ME518122
E320	S6K	49179-02260 ME517952
E320B	3066	49179-02300 ME518018

增压器 TURBOCHARGER

E325	3116	
E325B	3116	
E325C	3116	177-0440
E330	3306	
E330B	3306	219-1909 106-7407
E330C风冷	3306	191-5094
E330C水冷	3306	
E330D风冷	C9	
E330D水冷	C9	216-7815
E350	3306	
E950/950B	3304	4N6859
D6D	3306	6N7924
D7G	3306	4N9544
966D	3306	1W9383
D8K	D342	6N7203
D5H	3304	7N4651
D5 D333C	3306	4N8969
	3406	7C6609
	3306	219-9710
	3412	7C2485
住友 SUMITOMO		
Turbo Model	Engine Model	Part No
SH120-1	4BD1	8-94418-3200
SH120-2/3/5	4BD1	49189-00540 491789-00570 8972234280
SH200-1	6BD1	114400-2720
SH200-2	6BG1	114400-3320
SH200-3	6BG1	114400-3890
SH260	4BD1/4BG1	49185-00540
SH265	4D31-3	49178-00500
S280	6BD1	114400-1070
SH340	6BD1	114400-1070
SH300	6D22	ME158162
SH240-5	4HK1	
神钢 HITACHI		
Turbo Model	Engine Model	Part No
SK120/1/2/3	4BD1/4BG1	49189-00540
SK200-1	6D31新款	ME088488
SK200-1	6D31老款	ME088256 49179-02110
SK200-3	6D31最新款	ME088488
SK200-5	6D34螺丝	ME088840 49185-01030
SK200-6	6D34螺丝	ME441234 49185-01020
SK230-6	6D34插管	ME088865 49186-00360
SK230-6E	6D34螺丝	49185-01030
SK330-6	6D16	ME078660
SK200-8	J05E	24100-4631
SK210-8	J05E	

SK250-8	J05E	
SK260-8	JO5E	
SK330-8	JO8E	
SK360-8	JO8E	
SK350-8	JO8E	
加藤 KATO		
Turbo Model	Engine Model	Part No
HD450	6D14	
HD450	4D31	
HD510/512	4D31 4	
HD650	6D14	
HD700	6D15	
HD700	6D14	
HD700-5	6D31老款	
HD700-7	6D31新款	
HD800	6D14	
HD820	6D34	
HD900	6D14	
HD900	6D15	
HD1023	6D22	
HD1250	6D22	
现代 Hyundai		
Turbo Model	Engine Model	Part No
R130	4BT3.9	
R190	6CT8.3	
R200	6BT5.9大口	
R200-5/220-5	6BT5.9大口	
R210-3	6BT5.9大口	
R210-5	6D16	
R210-5	6D14	
R210-7	6BT5.9小口	
R215-7	6CT8.3	
R220-7	6BT5.9大口	
R225-7	6BT5.9	
R290-3	6CT8.3	
R300-3	6CT8.3	
R300-5	6CT8.3	
R450-3/5	L10	
大宇 DAEWOO		
Turbo Model	Engine Model	Part No
DH220-5	DB58	
DH220-7	DB58	
DH258	D1146	
DH300/-5	D1146	
DH300-7		
DH320		

增压器 TURBOCHARGER

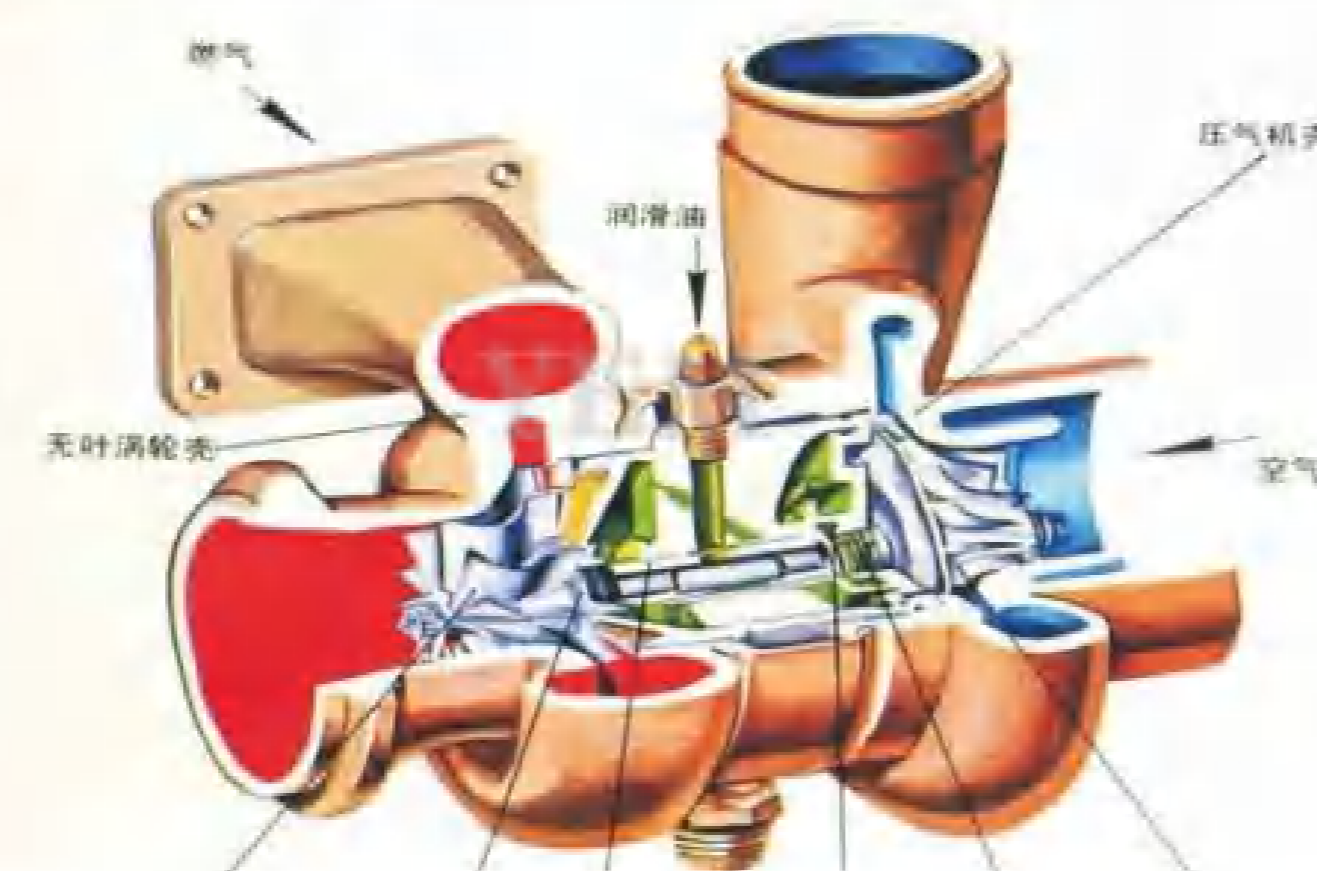

DH330	D1146T	
DH350		
沃尔沃	VOLVO	
Turbo Model	Engine Model	Part No
EC210	D6DEAE	
EC210B	D6DEAE	
EC240	D6DEAE	
EC260		
EC290	D7DEAE2	
EC360	D108EAE2	
EC360B		
EC460	D108EAE2	
EC420		
康明斯	CUMMINS	
Turbo Model	Engine Model	Part No
TA31	4B 3.9	728001-0002
HX30W	4BT	4050220/221
H1C	4BT 3.9	3522900
HX30	4BTA	3592112 3592109
HX35	6BT	3597913 3599686 3597914
HX35	6BT	3536338 3536339 3537132 3537133 3598176 3539697 3537134 3537135 3537136 3537137 3539428 3539429 3539956 3593089 3591122 3591123 3591124
WH1C	6BT	451567-5005
TA3407	6BT	3536313 3802694 3536321 3536971 3538868 3538626 3536977
HX35W	6BT	702646-5005
TBP4	6BTAA	3802303 3802126
HIE	6CT	3533000 3533008 3533370 3533369 3535005 3536818
HX40	6CT	4050204
HX40W	6CT	3528174
WHIE	6CT	3594067 3594066 3594027
HX80	K19	3594131
H2C	L10	3519092 3519095 3801489
H2D	L10	3525237 3803024
HX50	M11	3522867
HT3B	NT	3523415
T-46	NT855	3026924
HT3B	NTC320	3522861
HX40W	QS	
HY35W	ISbe	4025225 4039139
HC5A	KTA19	3593155/3597179
HC5A	KTA38	3523850 3594027
ST-50	NT855	3524451
日立 五十铃 日野	Hitachi Isuzu Hino	
Turbo Model	Engine Model	Part No
TB25	JX493ZQ	111830TC 471169-5006
TB25	JX493ZQ	1118300ADB1 471169-5002
GT22	JX493ZQ	1118300SZ 736210-5005

GT22	JX493ZQ	1118300DL 736210-5009
RHB5	4GB1	8971760801
RHB5	4JB1	8970385180/1
RHF4	4JB1	8971397243
RHF5	4JB1 2.8	8973659480
RHF6	4BD1	8944183200
TB25	NPR 3.9L	8943829000
TD04-15G	4BG1	8943675161 49189-00501
RHE7	K13C	24100-3064A
TB4154	6BD1	114400-2720
T04B83		114400-1331 465467-0005
TA5108	6RB1	114400-2080 466860-0005
T04E63		24100-3218A
TBP430		24100-3301A
TBP431	YF75	24100-3331A
HX55W		4051174 W860255956
HX50W		4027959 24100-2920A/B
GT3576	J08C	24100-3251C
	K13C	24100-2741B 2711B\12 3130
三菱	Mitsubishi	
Turbo Model	Engine Model	Part No
TD04	SJ 4D56	49177-01500/1
TD04	4D56 DE	49177-01510
TD04	4D56 2.5LD DE	49177-01511
TF035	4D56	49135-02110
TF035	4M40	49135-03110
TD06-17C	6D14	49175-00418
TD06-6		ME132165 49179-00500
TD07-9	6D16	49187-00271
TD07-9	6D16	49187-01010
TD08		49174-01142
TD08		49188-01262
TD05H	Galant 2.0CP	MD168037 49178-01410
TD06-17C		49175-00418
TD06-6	4D31	ME132165 49179-00500
TD07-9	6D16	49187-00271
TD07-9	6D16	49187-01010
TD05H	Galant	MD168037 49178-01410



水泵 WATER PUMP

YEM-H2690	YEM-H2691	YEM-H2692	YEM-H2693
PC400-6 S6D125E 6151-62-1102	PC300-6 6D108 8槽 6222-63-1200	6D125 PC300-3 PC400-5 6151-61-1101	PC200-6 (6D95) 6209-61-1100 6206-61-1505
YEM-H2694	YEM-H2695	YEM-H2696	YEM-H2697
PC200-1/2 6D105 6136-61-1102	PC400-1 6D110 6138-61-1860	PC60 S4D95 6209-61-1100	PC200-3 6D105 6136-62-1102
YEM-H2698	YEM-H2699	YEM-H2700	YEM-H2701
PC300-6 6D108 4槽 6221-61-1102	6D95 PC200-5 6206-61-1102	R220-5 6D102 PC200-6/7/8 6BT5.9 3389145 6735-61-1501	4D95L 6121-61-1610
YEM-H2702	YEM-H2703	YEM-H2704	YEM-H2705
S6D155 D155A1 6124-61-1004	D355C1 SA6D155 6127-61-1008	6SD1 EX300-5	6134-61-1410 S4D105-5
YEM-H2706	YEM-H2707	YEM-H2708	YEM-H2709
6212-61-1440 S6D140	6162-63-1012 S6D170	S6D140 6212-61-1203	4D94





















YEM-H2710  4D94E	YEM-H2711  620660951505	YEM-H2712  16110-79025 IDZ	YEM-H2713  6SD1 EX300-2/3
YEM-H2714  EX200-2 住友200 6孔	YEM-H2715  4BD1 SH120 EX120 SK120	YEM-H2716  EX200-1 住友280 4孔	YEM-H2717  BD30 EX60/70
YEM-H2718  EX220-1/2/3 H06CT	YEM-H2719  EX60	YEM-H2720  6BG1 EX200-5	YEM-H2721  E55 EX55
YEM-H2722  4BG1T	YEM-H2723  1-13610015-1 6QA1	YEM-H2724  1-13610857-0 6RB1T	YEM-H2725  8-94376855-0 NPR 4BG1
YEM-H2726  1-87810663-0 E120	YEM-H2727  ZX330 6HK1	YEM-H2728  6BG1T	YEM-H2729  E320C 3066T 178-6633

YEM-H2730  E3208 2W1225	YEM-H2731  E3204 2W1223	YEM-H2732  E330C 卡特水泵	YEM-H2733  E307B Sh60 4M40
YEM-H2734  E325B/C 3116	YEM-H2735  E3126 224-3255	YEM-H2736  S6K	YEM-H2737  3306T 2P0662
YEM-H2738  3006T 2P0661	YEM-H2739  3306T 2W8002	YEM-H2740  3006T 2W8001	YEM-H2741  2W8003 3306T
YEM-H2742  4N7498 D8L	YEM-H2743  176-7000 C12	YEM-H2744  C4.4	YEM-H2745  1615718 3412
YEM-H2746  8-94104755-0 C190	YEM-H2747  康明斯R300-5 6CT.8.3	YEM-H2748  R300-5 6CT8.3	YEM-H2749  NH220 康明斯 6685-61-1024

水泵 WATER PUMP

<p>YEM-H2750</p>  <p>NT855 3055747</p>	<p>YEM-H2751</p>  <p>6BT</p>	<p>YEM-H2752</p>  <p>M11 3073693</p>	<p>YEM-H2753</p>  <p>NH220-3945361C</p>
<p>YEM-H2754</p>  <p>R200-5老 R200 三菱</p>	<p>YEM-H2755</p>  <p>R200-5新 R210-5 三菱</p>	<p>YEM-H2756</p>  <p>6D14新 6D15新 HD800</p>	<p>YEM-H2757</p>  <p>6D14旧 6D15旧 HD800</p>
<p>YEM-H2758</p>  <p>HD1250 6D22 机油</p>	<p>YEM-H2759</p>  <p>6D22 黄油</p>	<p>YEM-H2760</p>  <p>HD700-5 SK200-3/5/6 6D316D34新款</p>	<p>YEM-H2761</p>  <p>4JB1五十铃</p>
<p>YEM-H2762</p>  <p>6D16 SK220-3</p>	<p>YEM-H2763</p>  <p>4D31 HD250 HD400 HD450</p>	<p>YEM-H2764</p>  <p>6D31老款</p>	<p>YEM-H2765</p>  <p>HD250 S4F 4D31</p>
<p>YEM-H2766</p>  <p>9-13610069 DA220</p>	<p>YEM-H2767</p>  <p>8-14600169-0 TCM C240</p>	<p>YEM-H2768</p>  <p>8-94376832 C240</p>	<p>YEM-H2769</p>  <p>8-94396670-0 6HE1T</p>



















水泵 WATER PUMP

<p>YEM-H2770</p>  <p>1-12365475 DH640</p>	<p>YEM-H2771</p>  <p>8-98038845-0 SH200-5 4HK1</p>	<p>YEM-H2772</p>  <p>8-98022822-1 ZAIK200-3 4HK1T</p>	<p>YEM-H2773</p>  <p>25100-72000 8DC91</p>
<p>YEM-H2774</p>  <p>31645-02021 4DR5</p>	<p>YEM-H2775</p>  <p>34545-00013 S4E</p>	<p>YEM-H2776</p>  <p>34545-10017 S4S</p>	<p>YEM-H2777</p>  <p>32B45-10031 S6S</p>
<p>YEM-H2778</p>  <p>30045-60067 6DB10</p>	<p>YEM-H2779</p>  <p>34545-0013A S4F</p>	<p>YEM-H2780</p>  <p>DL</p>	<p>YEM-H2781</p>  <p>04204095 2012</p>
<p>YEM-H2782</p>  <p>04206747 1013</p>	<p>YEM-H2783</p>  <p>T4131E025 1006TAG</p>	<p>YEM-H2784</p>  <p>S4F</p>	<p>YEM-H2785</p>  <p>DA640</p>
<p>YEM-H2786</p>  <p>4D34</p>	<p>YEM-H2787</p>  <p>6D16</p>	<p>YEM-H2788</p>  <p>DH220-3</p>	<p>YEM-H2789</p>  <p>DH220-5 DB58T</p>

水泵 WATER PUMP

<p>YEM-H2790</p>  <p>DH280-3 D2366</p>	<p>YEM-H2791</p>  <p>DE12TIS</p>	<p>YEM-H2792</p>  <p>DH300-5</p>	<p>YEM-H2793</p>  <p>洋马4TNV94</p>
<p>YEM-H2794</p>  <p>洋马4D89-2</p>	<p>YEM-H2795</p>  <p>洋马4TNE88</p>	<p>YEM-H2796</p>  <p>VOLVO210/290 沃尔沃水泵</p>	<p>YEM-H2797</p>  <p>VOLVO</p>
<p>YEM-H2798</p>  <p>VOLVO</p>	<p>YEM-H2799</p>  <p>8-97028590-0 4JG2</p>	<p>YEM-H2800</p>  <p>V32 4G54</p>	<p>YEM-H2801</p>  <p>16100-00705 2J 六孔</p>
<p>YEM-H2802</p>  <p>16100-49655 5M</p>	<p>YEM-H2803</p>  <p>16100-71200 1Z.2Z.11Z</p>	<p>YEM-H2804</p>  <p>16100-78701-71 7F 2Z</p>	<p>YEM-H2805</p>  <p>16100-21470 2J 五孔</p>
<p>YEM-H2806</p>  <p>2Z</p>	<p>YEM-H2807</p>  <p>7F 2Z</p>	<p>YEM-H2808</p>  <p>16100-49836 H20-11</p>	<p>YEM-H2809</p>  <p>21010-19010 FD46T</p>

水泵 WATER PUMP

<p>YEM-H2810</p>  <p>尼桑 2100896107 PD6</p>	<p>YEM-H2811</p>  <p>21010-37526 SD25</p>	<p>YEM-H2812</p>  <p>H20</p>	<p>YEM-H2813</p>  <p>尼桑 2108-96073 PE6</p>
<p>YEM-H2814</p>  <p>日野 16100-2522 W04D</p>	<p>YEM-H2815</p>  <p>日野 16100-2531 W06E</p>	<p>YEM-H2816</p>  <p>16100-2952 EF750</p>	<p>YEM-H2817</p>  <p>16100-3122 EK100</p>
<p>YEM-H2818</p>  <p>16100-3264 H07CT</p>	<p>YEM-H2819</p>  <p>EP100</p>	<p>YEM-H2820</p>  <p>J08E</p>	<p>YEM-H2821</p>  <p>DSC12</p>
<p>YEM-H2822</p>  <p>SCANIA</p>	<p>YEM-H2823</p>  <p>11-7319 11-0506-0001-09</p>	<p>YEM-H2824</p> 	
<p>YEM-H2825</p>  <p>04259548 DF416M1013ECP</p>	<p>YEM-H2826</p>  <p>T4131011C 1004TAG</p>	<p>YEM-H2827</p> 	

水泵 WATER PUMP

机油泵系列 OILPUMP



<p>YEM-H2828</p>  <p>D782 1G820-73030 1G820-73035</p>	<p>YEM-H2829</p>  <p>1A021-73030直接替换 16412-73030 最长款</p>	<p>YEM-H2830</p>  <p>V1505 16251-73034 16241-73034</p>	<p>YEM-H2831</p>  <p>V2403-7 15521-73033 6675652 铸铁</p>
<p>YEM-H2832</p>  <p>V2403 1K321-73030 forklift truck</p>	<p>YEM-H2833</p>  <p>V2607 1J700-73030</p>	<p>YEM-H2834</p>  <p>V3300 V3800 1C010-73030 6680852</p>	<p>YEM-H2835</p>  <p>V3307 1G772-73032</p>
<p>YEM-H2836</p>  <p>V2203 1A051-73032 6684865 不带管</p>	<p>YEM-H2837</p>  <p>D722方 19883-73030 15881-73033</p>	<p>YEM-H2838</p>  <p>D722圆 19883-73030 15881-73033</p>	<p>YEM-H2839</p>  <p>V1902 D1402 通用于02系列 直接替换15521-73039 15521-73033, 15521-73035</p>
<p>YEM-H2840</p>  <p>V2403 1G730-73032 6684865 带管</p>	<p>YEM-H2841</p>  <p>YANMAR 3D82</p>	<p>YEM-H2842</p>  <p>NISSAN PD6 PE6 21008-96107</p>	<p>YEM-H2843</p>  <p>MITSUBISHI K4N</p>

<p>YEM-H2844</p>  <p>E200B 5I-7948</p>	<p>YEM-H2845</p>  <p>E320/E320B/E320C 178-6539/34335-23010</p>	<p>YEM-H2846</p>  <p>E320机油泵 E320C不带中冷</p>	<p>YEM-H2847</p>  <p>E320C机油泵 带中冷</p>
<p>YEM-H2848</p>  <p>Model:4D95L(12mm) Application:KOMATSU OEM:6204-51-1200</p>	<p>YEM-H2849</p>  <p>Model:4D95L(16mm) Application:KOMATSU OEM:6206-51-1200</p>	<p>YEM-H2850</p>  <p>Model:4D95L(21mm) Application:KOMATSU OEM:6207-51-1201</p>	<p>YEM-H2851</p>  <p>Model:6D95L 20T Application:KOMATSU OEM:6209-51-1700</p>
<p>YEM-H2852</p>  <p>Model:6D95 21T Application:KOMATSU OEM:6206-51-1201</p>	<p>YEM-H2853</p>  <p>PC200-7 直R</p>	<p>YEM-H2854</p>  <p>Model:6CT(8.3) Application:CUMMINS OEM:3930338</p>	<p>YEM-H2855</p>  <p>Model:PC200-3 Application:KOMATSU OEM:6136-52-1210</p>
<p>YEM-H2856</p>  <p>PC360-7 6CT 宽款</p>	<p>YEM-H2857</p>  <p>Model:S6D108 PC300-5 Application:KOMATSU OEM:6221-51-1101-1</p>	<p>YEM-H2858</p>  <p>Model:PC300-6 Application:KOMATSU OEM:6221-53-1101-1</p>	<p>YEM-H2859</p>  <p>6D155机油泵 OEM:9128-52-1013</p>
<p>YEM-H2860</p>  <p>Model:6D125 平 Application:KOMATSU OEM:6206-51-1201</p>	<p>YEM-H2861</p>  <p>Model:S6D125 凸 Application:KOMATSU OEM:6151-51-1005-1</p>	<p>YEM-H2862</p>  <p>Model:4JB1 Application:ISUZU OEM:8-94335587-0 8-97033176-3</p>	<p>YEM-H2863</p>  <p>Model:4JG1 (Small filter cloth) Application:ISUZU OEM:ME-8-94362923-3</p>

机油泵系列 OILPUMP

<p>YEM-H2864</p>  <p>Model:6BD1T Application:ISUZU OEM:1-13100244-1</p>	<p>YEM-H2865</p>  <p>Model:6BG1 Application:ISUZU OEM:1-13100277-0</p>	<p>YEM-H2866</p>  <p>6HK1 直喷 8-94390414-3</p>	<p>YEM-H2867</p>  <p>6HK1 电喷 8-94395564-3</p>
<p>YEM-H2868</p>  <p>Model:6RB1 Application:ISUZU OEM:1-13100210-0</p>	<p>YEM-H2869</p>  <p>Model:H06CT Application:HINO OEM:15110-1631C</p>	<p>YEM-H2870</p>  <p>Model: H07CT Application:HINO OEM: 15163-1390</p>	<p>YEM-H2871</p>  <p>Model:PD6 Application:NISSAN OEM:15010-96015</p>
<p>YEM-H2872</p>  <p>帕金斯4132F071</p>	<p>YEM-H2873</p>  <p>帕金斯4132F073</p>	<p>YEM-H2874</p>  <p>Model:4D31 Application:MITSUBISHI OEM:ME014603</p>	<p>YEM-H2875</p>  <p>Model: 4D32 Application:MITSUBISHI OEM:ME084586</p>
<p>YEM-H2876</p>  <p>Model:4D34 Application:MITSUBISHI OEM:ME017484</p>	<p>YEM-H2877</p>  <p>Model: 6D31 (2FILTER) Application:MITSUBISHI OEM:ME014600</p>	<p>YEM-H2878</p>  <p>6D34 新款</p>	<p>YEM-H2879</p>  <p>Model:6D14 48T直 Application:MITSUBISHI OEM:ME034664 48T斜</p>
<p>YEM-H2880</p>  <p>6D16 59T斜 ME074345</p>	<p>YEM-H2881</p>  <p>Model:8DC9/8DC91 Application:MITSUBISHI OEM:ME091142</p>	<p>YEM-H2882</p>  <p>Model: NH220 Application:CUMMINS OEM:3042378 AR9835</p>	<p>YEM-H2883</p>  <p>E330C</p>



























机油泵系列 OILPUMP

<p>YEM-H2884</p>  <p>C9</p>	<p>YEM-H2885</p>  <p>C13</p>	<p>YEM-H2886</p>  <p>J05</p>	<p>YEM-H2887</p>  <p>J08 9孔 11T 21T 15110-2150</p>
<p>YEM-H2888</p>  <p>J08</p>	<p>YEM-H2889</p>  <p>3D84</p>	<p>YEM-H2890</p>  <p>4D84</p>	<p>YEM-H2891</p>  <p>4TNV98</p>
<p>YEM-H2892</p>  <p>4TNV94</p>	<p>YEM-H2893</p>  <p>久保田</p>	<p>YEM-H2894</p>  <p>VOV290机油泵</p>	<p>YEM-H2895</p>  <p>DB58 65.05101-7021</p>
<p>YEM-H2896</p>  <p>D1146 OEM:65.05100-6023</p>	<p>YEM-H2897</p>  <p>E320C 机油泵盖</p>	<p>YEM-H2898</p>  <p>Model:3306 Application:CATEPILLAR OEM:4W2448</p>	<p>YEM-H2899</p>  <p>6HK1 电喷</p>
<p>YEM-H2900</p>  <p>6HK1 直喷</p>	<p>YEM-H2901</p>  <p>NT855 OEM: 3821572</p>	<p>YEM-H2902</p>  <p>NT855 OEM:AR10172</p>	<p>YEM-H2903</p>  <p>51-7686 34335-12070 24齿</p> <p>51-7558 34335-03031 9齿</p>

















输油泵系列 FUELINJECTION PUMP

输油泵系列 FUELINJECTION PUMP

<p>YEM-H2904</p>  <p>6D102 手油泵 105220-5960</p>	<p>YEM-H2905</p>  <p>PC400-6 手油泵 105217-6030</p>	<p>YEM-H2906</p>  <p>320C 手油泵</p>	<p>YEM-H2907</p>  <p>6BG1 手油泵 H5750198-0 1-15750192-0</p>
<p>YEM-H2908</p>  <p>6BD1 手油泵</p>	<p>YEM-H2909</p>  <p>6HK1 手油泵 1-15750130-0</p>	<p>YEM-H2910</p>  <p>S6K 手油泵</p>	<p>YEM-H2911</p>  <p>4HF1 手油泵</p>
<p>YEM-H2912</p>  <p>6D17 手油泵</p>	<p>YEM-H2913</p>  <p>DH220-5 手油泵</p>	<p>YEM-H2914</p>  <p>DH300-5 手油泵 105207-1520</p>	<p>YEM-H2915</p>  <p>6D34 手油泵</p>
<p>YEM-H2916</p>  <p>8DC9 手油泵</p>	<p>YEM-H2917</p>  <p>8DC91 手油泵</p>	<p>YEM-H2918</p>  <p>日野FE100 三菱MITSUBISHI</p>	<p>YEM-H2919</p>  <p>PC360手压泵 博士手压泵</p>
<p>YEM-H2920</p>  <p>CAT 20MM 2W2605 183-2823</p>	<p>YEM-H2921</p>  <p>CAT3304 12MM 137-5541</p>	<p>YEM-H2922</p>  <p>E320C 10MM 4W0788 1052508</p>	<p>YEM-H2923</p>  <p>CAT 9H2256</p>

<p>YEM-H2924</p>  <p>6D114 3936316 大孔</p>	<p>YEM-H2925</p>  <p>6D114 3936318 小孔</p>	<p>YEM-H2926</p>  <p>3904374/3917998 枪式</p>	<p>YEM-H2927</p>  <p>VOLVO手压输油泵</p>	<p>YEM-H2928</p>  <p>VOLVO 210B 20917999 20518337</p>	
<p>YEM-H2929</p>  <p>VOLVO 210 21584586</p>	<p>YEM-H2930</p>  <p>VOLVO210大轮</p>	<p>YEM-H2931</p>  <p>VOLVO新款输油泵(铁) 4孔</p>	<p>YEM-H2932</p>  <p>1W1698</p>	<p>YEM-H2933</p>  <p>E330C</p>	
<p>YEM-H2934</p>  <p>神钢-8手压泵</p>	<p>YEM-H2935</p>  <p>4JB1 神钢60手压泵</p>	<p>YEM-H2936</p>  <p>B3.3手油泵</p>	<p>YEM-H2937</p>  <p>3D84输油泵</p>	<p>YEM-H2938</p>  <p>洋马 YANMAR 4D84</p>	
<p>YEM-H2939</p>  <p>6BT5.9 烟斗 3904574/3904374</p>	<p>YEM-H2940</p>  <p>洋马电子燃油泵(优) 12V/24V 白插 YANMAR FUEL PUMP</p>	<p>YEM-H2941</p>  <p>洋马电子燃油泵(优) 12V/24V 大黑插 YANMAR FUEL PUMP</p>	<p>YEM-H2942</p>  <p>洋马电子燃油泵 12V/24V 白插 YANMAR FUEL PUMP</p>	<p>YEM-H2943</p>  <p>洋马电子燃油泵 12V/24V 小黑插 YANMAR FUEL PUMP</p>	
<p>YEM-H2944</p>  <p>洋马电子燃油泵(长) 12V/24V YANMAR FUEL PUMP</p>	<p>YEM-H2945</p>  <p>洋马电子燃油泵(方) 12V/24V YANMAR FUEL PUMP</p>	<p>YEM-H2946</p>  <p>大宇电子燃油泵 DAEWOO FUEL PUMP</p>	<p>YEM-H2947</p>  <p>久保田电子燃油泵 12V/24V 带继电器 KUBOTA/YANMAR FUEL PUMP</p>	<p>YEM-H2948A</p>  <p>4HK1/6HK1 ZAX200/230/ 240/330-3</p>	<p>YEM-H2948B</p>  <p>电子燃油泵 VOLVO360</p>















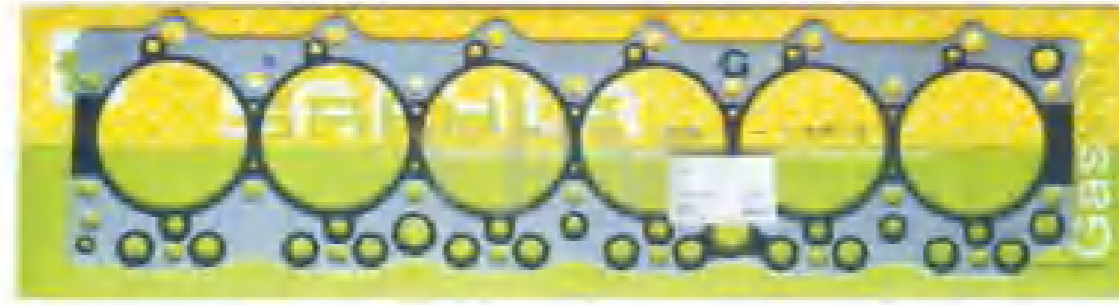

大修包 GASKET KIT

<p>YEM—H2949</p>  <p>PC200-6</p>	<p>YEM—H2950</p>  <p>S6KT</p>	<p>YEM—H2951</p>  <p>S4D105-3</p>	
<p>YEM—H2952</p>  <p>6D125-0</p>	<p>YEM—H2953</p>  <p>6D108</p>	<p>YEM—H2954</p>  <p>6D108</p>	
<p>YEM—H2955</p>  <p>6D31T ME997693</p>	<p>YEM—H2956</p>  <p>S6D95 6207-K1/K2-2004</p>	<p>YEM—H2957</p>  <p>6BD1 1-87811-316-0</p>	
<p>YEM—H2958</p>  <p>6D34 ME996454</p>	<p>YEM—H2959</p>  <p>S4KT 34294-300011</p>	<p>YEM—H2960</p>  <p>S6KT 34394-10011</p>	
<p>YEM—H2961</p>  <p>6D102-6</p>	<p>YEM—H2962</p>  <p>BF4M2012 T</p>	<p>YEM—H2963</p>  <p>4LE2 T</p>	
<p>YEM—H2964</p>  <p>4D94E</p>	<p>YEM—H2965</p>  <p>4TNV94</p>	<p>YEM—H2966</p>  <p>PC400-8</p>	<p>YEM—H2967</p>  <p>VOLVO边盖修理包</p>

大修包 GASKET KIT

<p>YEM—H2968</p>  <p>PC300-6 6D108</p>	<p>YEM—H2969</p>  <p>PC200-5 6D95</p>	<p>YEM—H2970</p>  <p>6D34</p>	<p>YEM—H2971</p>  <p>4BD1</p>
<p>YEM—H2972</p>  <p>6D110</p>	<p>YEM—H2973</p>  <p>S6D155</p>	<p>YEM—H2974</p>  <p>6D16T (方孔)</p>	<p>YEM—H2975</p>  <p>6D15T</p>
<p>YEM—H2976</p>  <p>6D14-0 6D14-N</p>	<p>YEM—H2977</p>  <p>E200B E320 E320B S6K-0 S6K-N</p>	<p>YEM—H2978</p>  <p>HD450/250 4D31T</p>	<p>YEM—H2979</p>  <p>HD1250 6D22</p>
<p>YEM—H2980</p>  <p>HD700-5 HD700-7 6D31-0 6D31-N</p>	<p>YEM—H2981</p>  <p>6D102 (下修包)</p>	<p>YEM—H2982</p>  <p>6D102 (上修包)</p>	<p>YEM—H2983</p>  <p>DA120/DA640</p>
<p>YEM—H2984</p>  <p>S4K-0</p>	<p>YEM—H2985</p>  <p>6RB1</p>	<p>YEM—H2986</p>  <p>PD6</p>	<p>YEM—H2987</p>  <p>6CT</p>
<p>YEM—H2988</p>  <p>W06E</p>	<p>YEM—H2989</p>  <p>FE6T</p>	<p>YEM—H2990</p>  <p>4M40</p>	<p>YEM—H2991</p>  <p>A: NT855 上 B: NT855 下</p>





















汽缸床 GASKET HEAD

<p>YEM-H2992</p>  <p>D6E</p>	<p>YEM-H2993</p>  <p>6D102</p>	<p>YEM-H2994</p>  <p>4TNV98 M</p>
<p>YEM-H2995</p>  <p>4TNV94</p>	<p>YEM-H2996</p>  <p>S6KM</p>	<p>YEM-H2997</p>  <p>4LE2</p>
<p>YEM-H2998</p>  <p>6D34 ME061734</p>	<p>YEM-H2999</p>  <p>6BG1 5-11141-196-0</p>	<p>YEM-H3000</p>  <p>4D102 3283333</p>
<p>YEM-H3001</p>  <p>S6D95 6206-11-1830</p>	<p>YEM-H3002</p>  <p>4D95 6204-11-1012</p>	<p>YEM-H3003</p>  <p>4BD1 5-1141-083-0</p>
<p>YEM-H3004</p>  <p>6D95</p>	<p>YEM-H3005</p>  <p>6BD1T</p>	<p>YEM-H3006</p>  <p>S4D95</p>
<p>YEM-H3007</p>  <p>6D14</p>	<p>YEM-H3008</p>  <p>6D16T</p>	<p>YEM-H3009</p>  <p>6D31</p>

汽缸床 GASKET HEAD

<p>YEM-H3010</p>  <p>汽缸床 6D15T</p>	<p>YEM-H3011</p>  <p>汽缸床 6D16</p>	<p>YEM-H3012</p>  <p>汽缸床 6D14</p>
<p>YEM-H3013</p>  <p>汽缸床 EX200-5 6BG1</p>	<p>YEM-H3014</p>  <p>汽缸床 EX300-2</p>	<p>YEM-H3015</p>  <p>汽缸床 EX200 6BD1</p>
<p>YEM-H3016</p>  <p>汽缸床 EX120 4BD1</p>	<p>YEM-H3017</p>  <p>汽缸床 PC200-6</p>	<p>YEM-H3018</p>  <p>汽缸床 PC200-3 S6D105</p>
<p>YEM-H3019</p>  <p>汽缸床 PC200-5 S6D95</p>	<p>YEM-H3020</p>  <p>汽缸床 PC300-6</p>	<p>YEM-H3021</p>  <p>汽缸床 PC60 4D95 铁</p>
<p>YEM-H3022</p>  <p>汽缸床 S4D105-5</p>	<p>YEM-H3023</p>  <p>汽缸床 HD700 6D31</p>	<p>YEM-H3024</p>  <p>汽缸床 4D130</p>
<p>YEM-H3025</p>  <p>汽缸床 S4D105-5</p>	<p>YEM-H3026</p>  <p>汽缸床 4D102</p>	<p>YEM-H3027</p>  <p>汽缸床 PC300-3</p>
<p>YEM-H3028</p>  <p>汽缸床 康明斯 NT855</p>	<p>YEM-H3029</p>  <p>汽缸床 康明斯 NH220</p>	<p>YEM-H3030</p>  <p>汽缸床 E200B S6KT 石棉</p>













消声器 MUFFLER

YEM-H3031  PC30MRX-1	YEM-H3032  PC35MR-1	YEM-H3033  PC40MR-1	YEM-H3034  SH120
YEM-H3035  徐工220	YEM-H3036  久保田50	YEM-H3037  SH350 6HK1	YEM-H3038  R220-5
YEM-H3039  SK200-6E	YEM-H3040  柳工920D	YEM-H3041  HD700-7	YEM-H3042  雷沃220
YEM-H3043  PC400-6	YEM-H3044  SK200-8	YEM-H3045  PC300-8	YEM-H3046  EX200-2
YEM-H3047  R215-7	YEM-H3048  S6D102	YEM-H3049  PC200-8仿原厂	YEM-H3050  柳工225

消声器 MUFFLER

YEM-H3051  SK07N2	YEM-H3052  PC270-7	YEM-H3053  E325C	YEM-H3054  SK120-3
YEM-H3055  DH225-7	YEM-H3056  SH60A1	YEM-H3057  D60-12	YEM-H3058  D40
YEM-H3059  YC85-7	YEM-H3060  力士德220 6BG1	YEM-H3061  YM50	YEM-H3062  R210-5
YEM-H3063  R220-5	YEM-H3064  Sh265	YEM-H3065  JCM913B	YEM-H3066  EX60-1
YEM-H3067  EX200-5	YEM-H3068  PC300-7	YEM-H3069  ZX450电	YEM-H3070  PC300-6

消声器MUFFLER

YEM-H3071  PC60-5	YEM-H3072  PC100-3	YEM-H3073  SK115	YEM-H3074  E320D
YEM-H3075  SK100-5	YEM-H3076  SH60A3	YEM-H3077  DH55-5	YEM-H3078  JBC220
YEM-H3079  HD450	YEM-H3080  HD800	YEM-H3081  HD250-7	YEM-H3082  HD1430-5
YEM-H3083  D31-20	YEM-H3084  E320C	YEM-H3085  E312	YEM-H3086  SH200
YEM-H3087  HD1250-7	YEM-H3088  SK200-6	YEM-H3089  玉柴60-7	YEM-H3090  HD820-3

消声器MUFFLER

YEM-H3091  FR220	YEM-H3092  YM40	YEM-H3093  PC200-5	YEM-H3094  PC300-5
YEM-H3095  ZX330	YEM-H3096  PC30-7	YEM-H3097  PC200-3	YEM-H3098  PC30-8
YEM-H3099  开元60-8	YEM-H3100A 	YEM-H3100B  A	YEM-H3100C  B PC300-7出气口
YEM-H3101  出气口	YEM-H3102  PC40MR-1出气口	YEM-H3103  消声器夹	YEM-H3104  固定螺丝
YEM-H3105  增压器夹	YEM-H3106  水管夹	YEM-H3107  水管夹	YEM-H3108  油管夹
YEM-H3109  S68102接管	YEM-H3110  R220-5接管		



机油散热器盖 OILCOOLER COVER

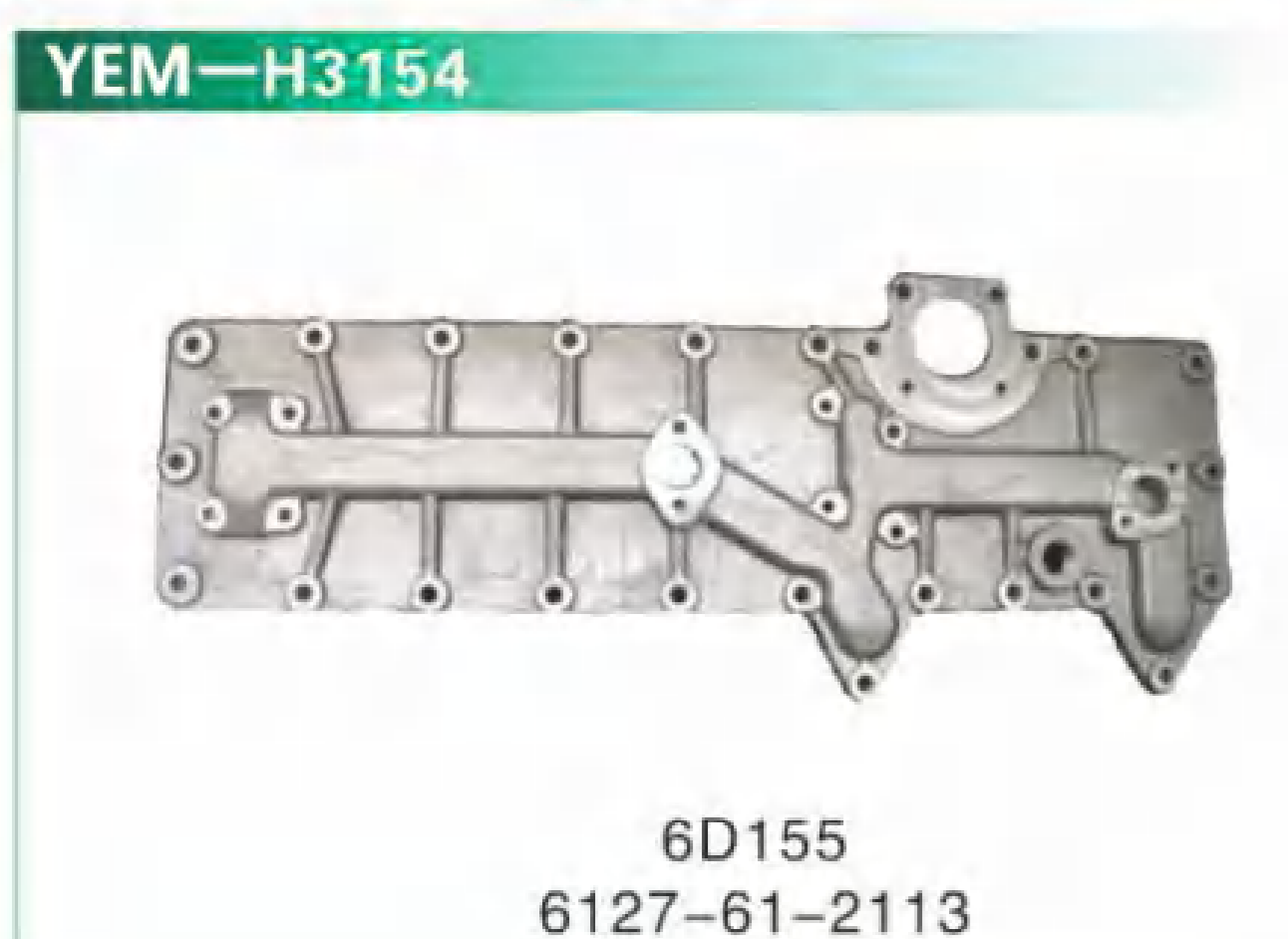
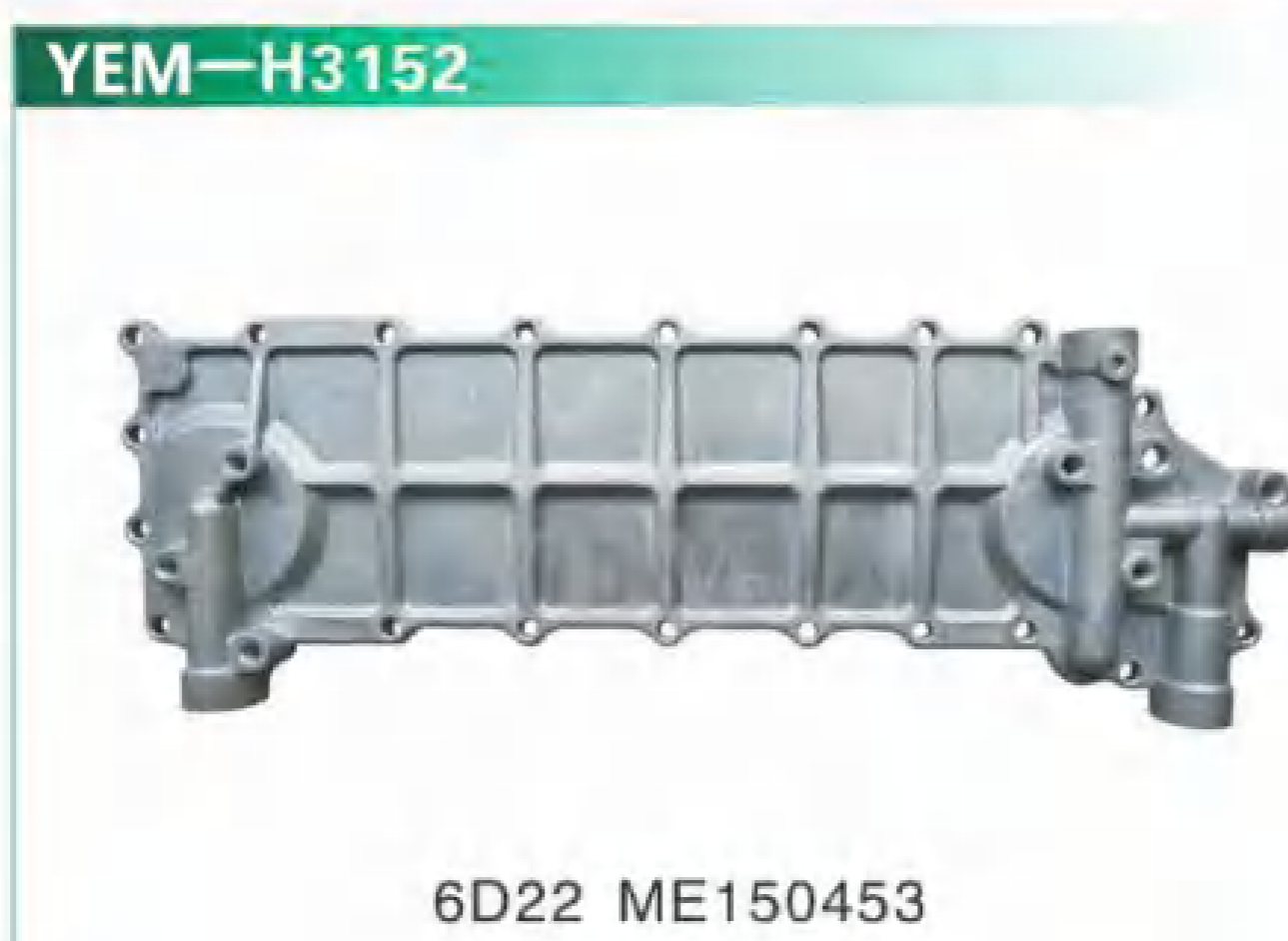
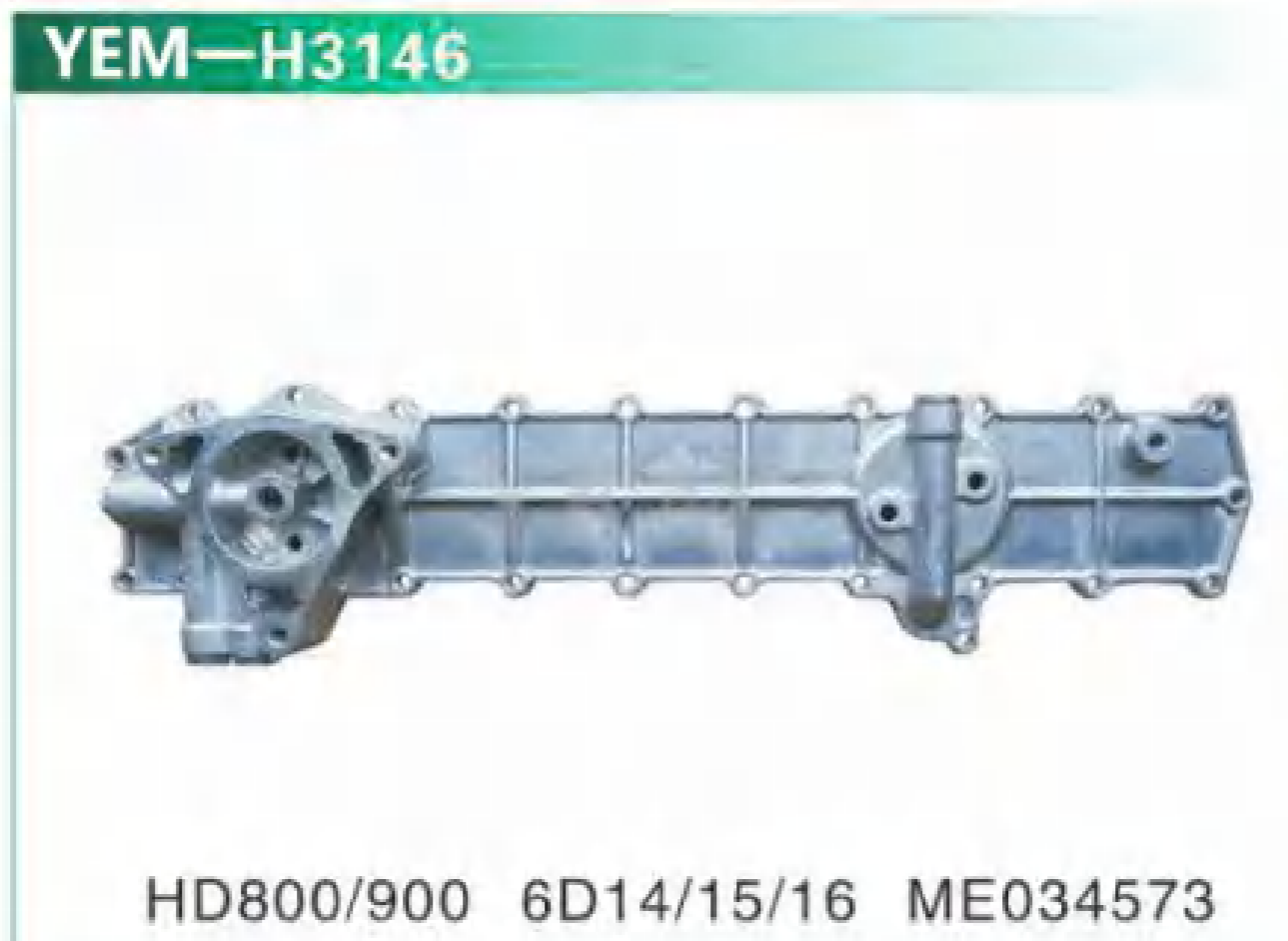
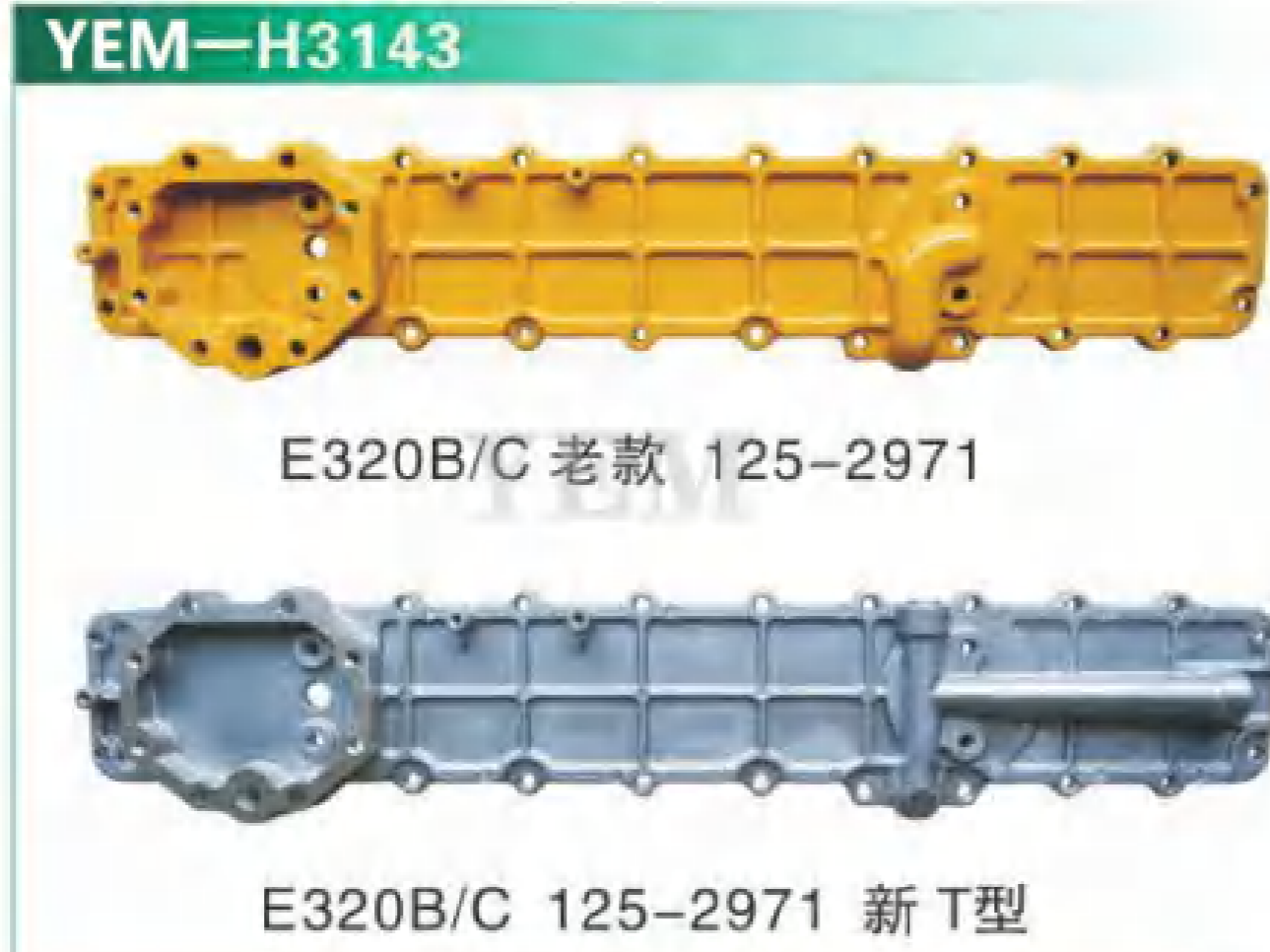

机油散热器盖 OILCOOLER COVER

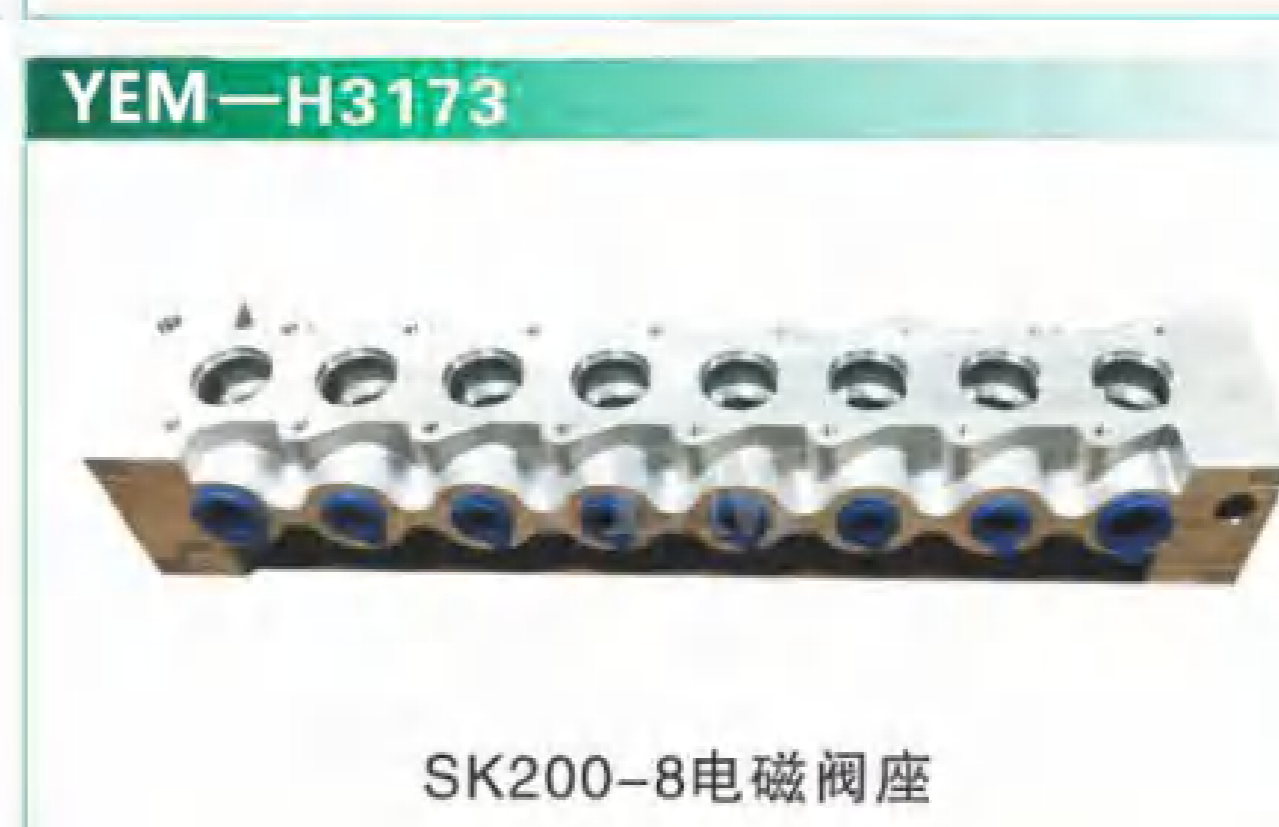
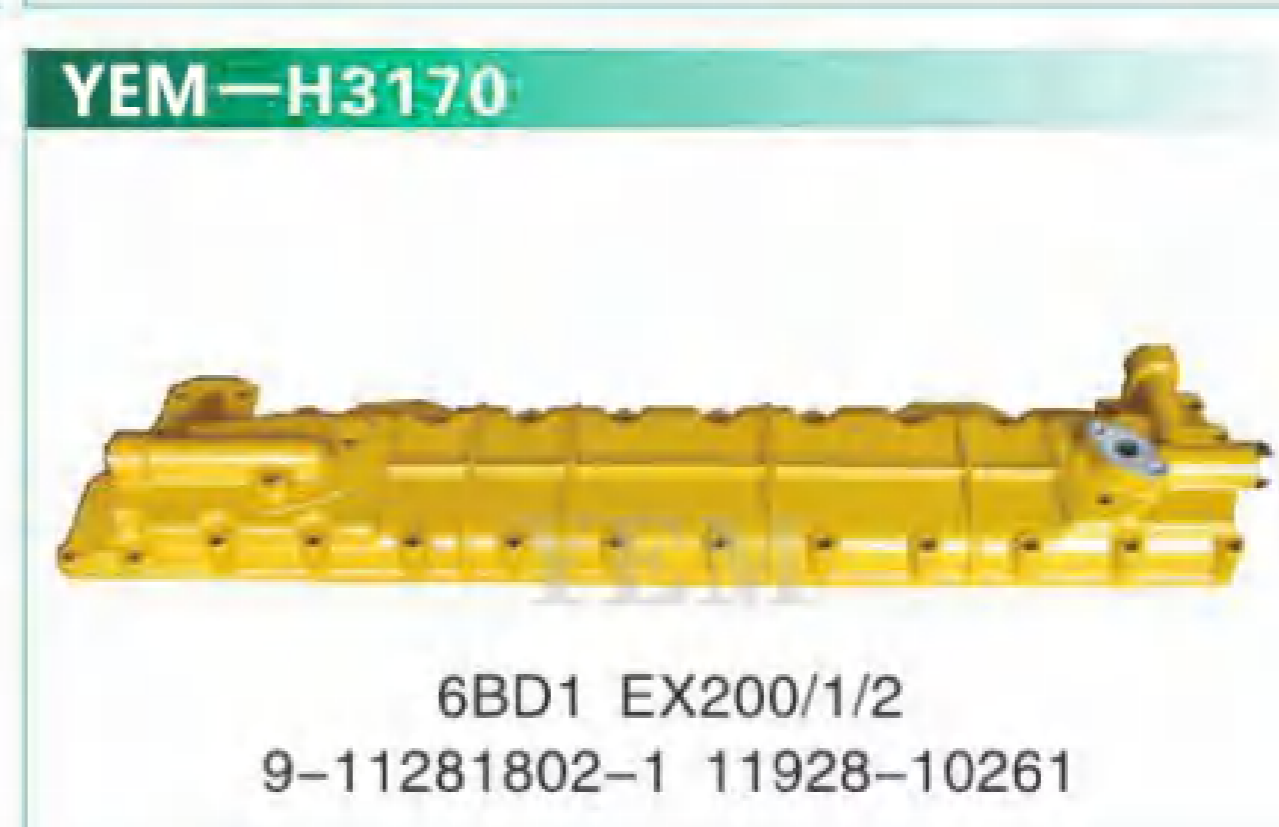
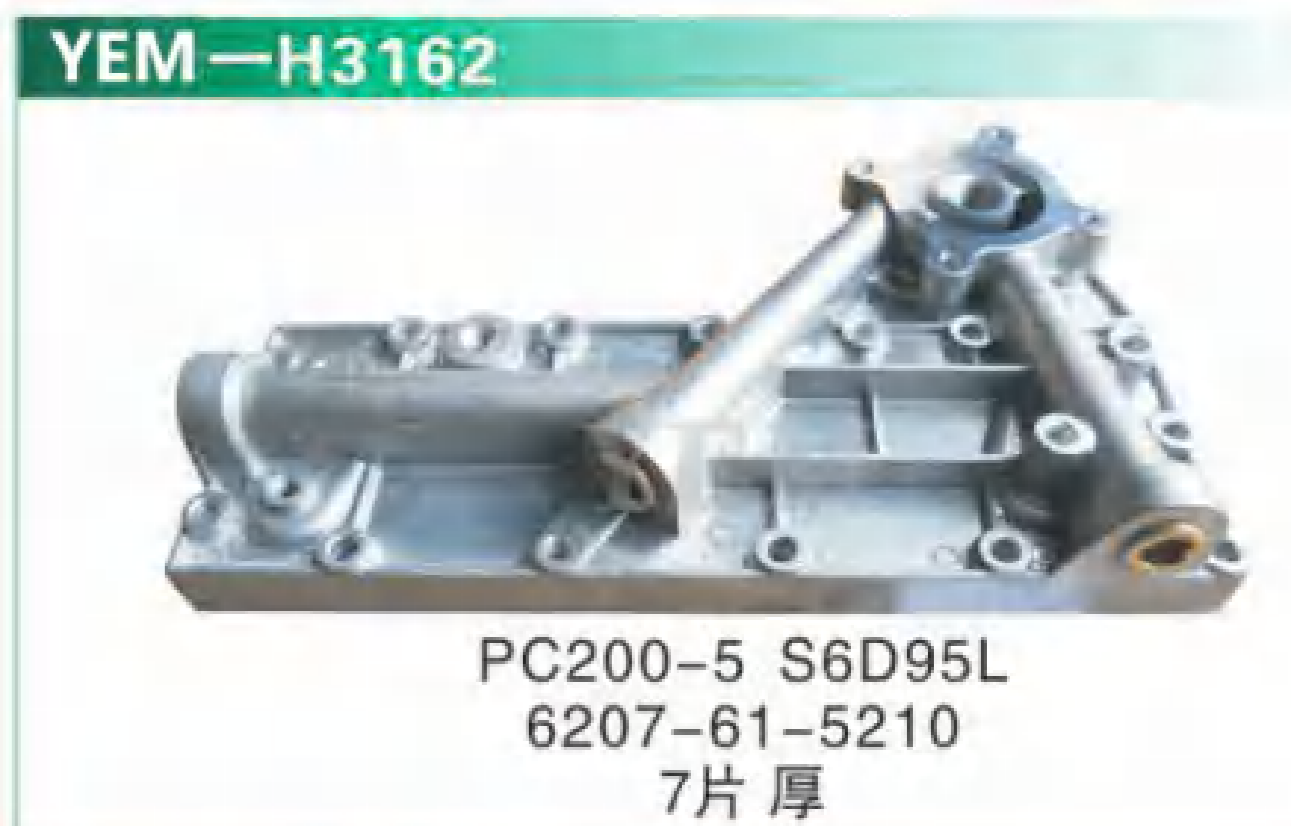
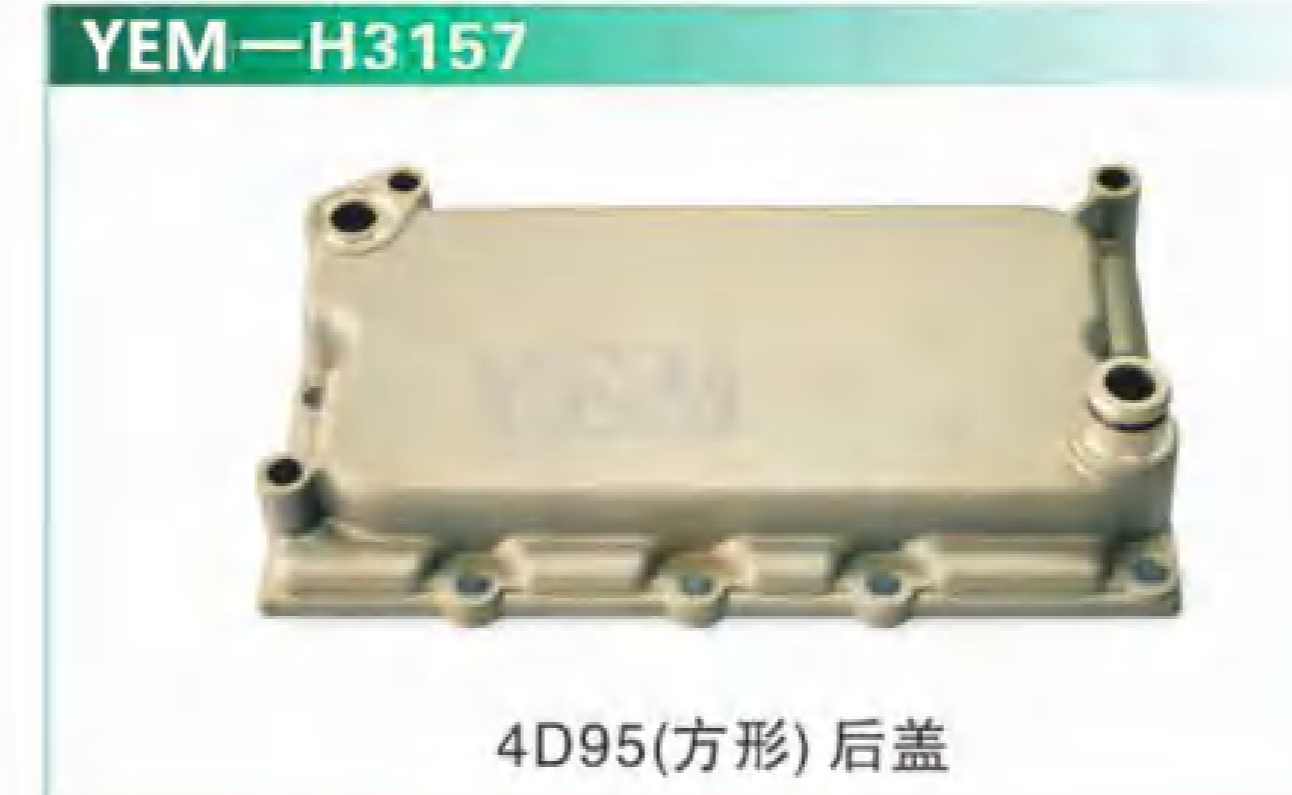

机油散热器盖 OIL COOLER COVER

气门室盖系列 COVER PLATE SERIES

<p>YEM-H3175</p>  <p>6CT PC300-7</p>	<p>YEM-H3176</p>  <p>VOLVO210</p>	<p>YEM-H3177</p>  <p>VOLVO 210 NEW</p>	<p>YEM-H3178</p>  <p>VOLVO290</p>
<p>YEM-H3179</p>  <p>6D24</p>	<p>YEM-H3180</p>  <p>4HF1</p>	<p>YEM-H3181</p>  <p>Oil Cooler Cover 6D114 3926044</p>	<p>YEM-H3182</p>  <p>EH700 EH100</p>
<p>YEM-H3183</p>  <p>EK100</p>	<p>YEM-H3184</p>  <p>J08C</p>	<p>YEM-H3185</p>  <p>S4K</p>	<p>YEM-H3186</p>  <p>S4K 4P</p>
<p>YEM-H3187</p>  <p>W04D</p>	<p>YEM-H3188</p>  <p>机油散热器总成 DH300-7 OIL COOLER COVER ASSY</p>	<p>YEM-H3189</p>  <p>4D31机油散热器总成</p>	<p>YEM-H3190</p>  <p>6HK1电喷</p>
<p>YEM-H3191</p>  <p>6HK1直喷</p>	<p>YEM-H3192</p>  <p>J08铝托架</p>	<p>YEM-H3193</p>  <p>卡特CP气门室盖</p>	<p>YEM-H3194</p>  <p>J05进气管</p>

<p>YEM-H3195</p>  <p>6D31 6D34气门室盖</p>	<p>YEM-H3196</p>  <p>6D102侧盖</p>	<p>YEM-H3197</p>  <p>DH220-5气门室盖</p>	<p>YEM-H3198</p>  <p>PC200-5(6D95)气门室盖 Cover Plate</p>
<p>YEM-H3199</p>  <p>6BD1 6BG1 气门室盖 OEM: 111170-9640</p>	<p>YEM-H3200</p>  <p>6D16/15/14气门室盖</p>	<p>YEM-H3201</p>  <p>4D95气门室盖 不带增压</p>	<p>YEM-H3202</p>  <p>S4K气门室盖</p>
<p>YEM-H3203</p>  <p>4BD1气门室盖</p>	<p>YEM-H3204</p>  <p>4BD1气门室盖</p>	<p>YEM-H3205</p>  <p>4D95气门室盖 带增压T</p>	<p>YEM-H3206</p>  <p>S6K气门室盖</p>
<p>YEM-H3207</p>  <p>4M40气门室盖Cover Plate</p>	<p>YEM-H3208</p>  <p>6HK1气门室盖</p>	<p>YEM-H3209</p>  <p>C9气门室盖</p>	<p>YEM-H3210</p>  <p>6D102气门室盖 6D34柴油泵连接盘</p>
<p>YEM-H3211</p>  <p>4JG1 4BG1 6BG1 4HK1 6HK1 2034607日立分油中底座</p>	<p>YEM-H3212</p>  <p>S6K连接盘</p>	<p>YEM-H3213</p>  <p>小松分油中盖</p>	<p>YEM-H3214</p>  <p>PC60-7油封盖</p>
<p>YEM-H3215</p>  <p>现代分油中盖</p>	<p>YEM-H3216</p>  <p>大字分油中盖</p>	<p>YEM-H3217</p>  <p>EX200300直喷液压力油箱铝盖</p>	<p>YEM-H3218</p>  <p>ZAX200330电喷液压力油箱铝盖</p>

机油散热器芯 OIL COOLER

YEM-H3219



PC60/4D95
600-651-1570 3P

YEM-H3220



PC60/4D95
600-651-1570 4P

YEM-H3221



PC120-6/4D102
6732-61-2110 3957543

YEM-H3222



PC200-2/3
6D105 S6K 200B
600-651-1411 3P

YEM-H3223



PC200-3/6D105/S6K/200B
5I-7563
600-651-1412/34399-02102 4P通用

YEM-H3224



S6K 6D108 E320B
125-2970 5P

YEM-H3225

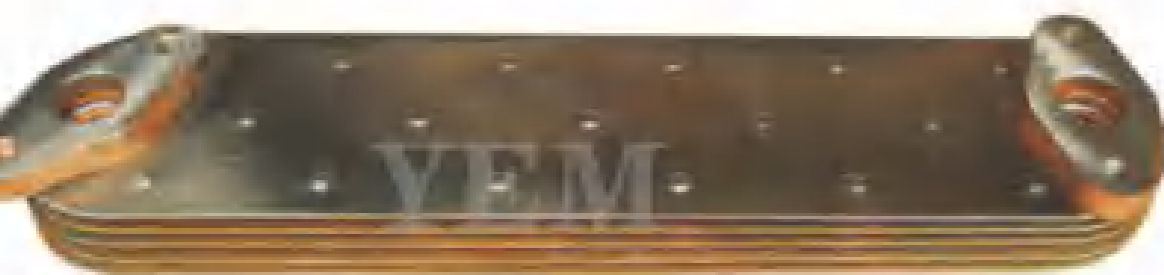

PC200-5/6D95
600-651-1520 5P

YEM-H3226



PC200-5/6D95
600-651-1550 7P

YEM-H3227



PC200-6/6D102 6BT5.9
6735-61-2110/3918176 7P

YEM-H3228



PC200-8 (6D107) 7片

YEM-H3229



PC200-8 (6D107) 8片

YEM-H3230



PC300-3 PC400-3/5/6 6D125
6150-61-2111 7P

YEM-H3231



6D125
6150-61-9320 10P

YEM-H3232



PC300-7 6CT 9P

YEM-H3233

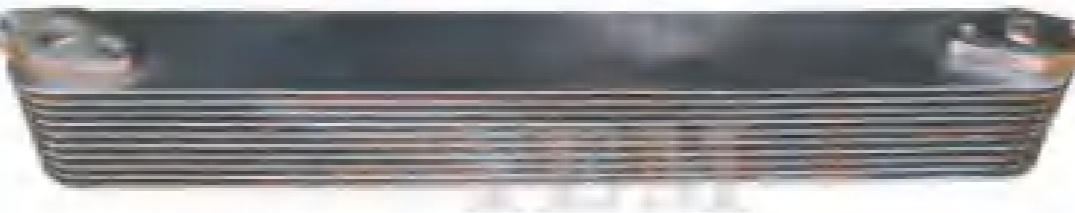

PC S6D155
600-651-1161 10P

YEM-H3234



4BD1 4P 八字型

YEM-H3235



4BD1 4P 两撇

YEM-H3236



EX300-3/5 6SD1 6P

YEM-H3237



EX200-1/2 6BD1
1-11282018-0 4P

YEM-H3238



ZAX 6BG1
1-11282027-0 5P

YEM-H3239



EX300-3/5 6SD1 7P

YEM-H3240



4HK1 4P

YEM-H3241



6HK1 1-21723066-0 5P

YEM-H3242



EX400-1 6RB1 7P

机油散热器芯 OIL COOLER

YEM-H3243



S4K 斜 4P

YEM-H3244



S4K 4P

YEM-H3245



HD800 6D14 4P

YEM-H3246



YEM-H3247



6D31/6D34 HD700-5 新款 5P

YEM-H3248



D1146 8P

YEM-H3250



VOLVO2240/290

YEM-H3251



VOLVO210

YEM-H3252



SH300 6D22/9P

YEM-H3254



J05 5P

YEM-H3255



SK350-8 J08 8P

YEM-H3253



D2366 9P

YEM-H3258



C9

YEM-H3259



C7

YEM-H3256



4M40

YEM-H3262



B3.3

YEM-H3263



PC130-7

YEM-H3257



EK100 (8P)

YEM-H3266



2P8797
7N0110M031

YEM-H3267



7N0128
9M8818

YEM-H3260



JCB

YEM-H3270



3306 芯子 Oil Cooler
OEM:7N0128

YEM-H3271



卡特油冷器
OEM:7N0165

YEM-H3261



4TNV9498

YEM-H3264



4W7190
4W7188

YEM-H3268



7N0165
7S6394

YEM-H3265



7N3505
7N3521M

YEM-H3272

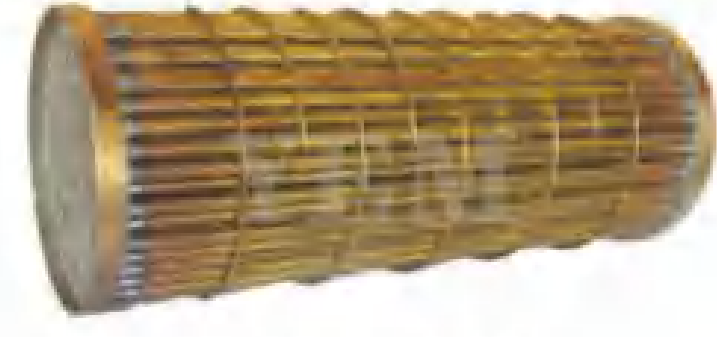

NT855 芯子
OEM:208149

YEM-H3273



卡特液压油格总成
158-9005
Oil cooler core

机油格座 OILFILTER HEAD

<p>YEM-H3274</p>  <p>CAT322-3154</p>	<p>YEM-H3275</p>  <p>E320B 1R-0739 8孔</p>	<p>YEM-H3276</p>  <p>E320C 1R-0739 4孔</p>	<p>YEM-H3277</p>  <p>E320C 4孔 机油座与机油散热器边盖连接体</p>
<p>YEM-H3278</p>  <p>CAT E320 KS196-6 517950</p>	<p>YEM-H3279</p>  <p>E329D IR-1807</p>	<p>YEM-H3280</p>  <p>CAT320C 41-3948</p>	<p>YEM-H3281</p>  <p>CAT320D IR-518670</p>
<p>YEM-H3282</p>  <p>E320D连体机油座</p>	<p>YEM-H3283</p>  <p>E200B KS192-6 短 SHORT</p>	<p>YEM-H3284</p>  <p>CAT330D机油格座 1R-0716/1R-1808</p>	<p>YEM-H3285</p>  <p>CAT200B 093-7521</p>
<p>YEM-H3286</p>  <p>CAT管路液压座 IR-8878</p>	<p>YEM-H3287</p>  <p>CAT330CD IR-0716/OR-1808</p>	<p>YEM-H3288</p>  <p>卡特330D机油座</p>	<p>YEM-H3289</p>  <p>E325B 1R-0751 旧款 OLD</p>
<p>YEM-H3290</p>  <p>PC200-6/6D95中间节</p>	<p>YEM-H3291</p>  <p>PC200-3/6D105 6134-51-5110</p>	<p>YEM-H3292</p>  <p>PC360-7机油连接座</p>	<p>YEM-H3293</p>  <p>PC400-6机油座</p>

机油格座 OILFILTER HEAD

<p>YEM-H3294</p>  <p>PC360-7机油格座 6742-01-4540</p>	<p>YEM-H3295</p>  <p>PC200-5 6D95</p>	<p>YEM-H3296</p>  <p>12101机油座</p>	<p>YEM-H3297</p>  <p>PC400-7 1340</p>
<p>YEM-H3298</p>  <p>PC200-6/6D95</p>	<p>YEM-H3299</p>  <p>PC130-7机油散热器座</p>	<p>YEM-H3300</p>  <p>PC160机油座 LF16011</p>	<p>YEM-H3301</p>  <p>PC200-5/6D95</p>
<p>YEM-H3302</p>  <p>PC220-7</p>	<p>YEM-H3303</p>  <p>EX200-1</p>	<p>YEM-H3304</p>  <p>日立200-3/5</p>	<p>YEM-H3305</p>  <p>日立电喷先导格座 4630525</p>
<p>YEM-H3306</p>  <p>日立电喷机油座 4484495</p>	<p>YEM-H3307</p>  <p>ZX70机油盘座</p>	<p>YEM-H3308</p>  <p>ZAX60管路座</p>	<p>YEM-H3309</p>  <p>ZAX60管路座</p>
<p>YEM-H3310</p>  <p>ZAX200-3机油格座</p>	<p>YEM-H3311</p>  <p>ZX230/6BG1T</p>	<p>YEM-H3312</p>  <p>SK-8机油格座</p>	<p>YEM-H3313</p>  <p>沃尔沃适配器两头一样大</p>

机油格座 OILFILTER HEAD

柴油格座 FUEL FILTER HEAD

<p>YEM-H3314</p>  <p>神钢-8机油座连接体</p>	<p>YEM-H3315</p>  <p>DH220-7</p>	<p>YEM-H3316</p>  <p>DH220-5</p>	<p>YEM-H3317</p>  <p>大字、斗山300机油格座</p>
<p>YEM-H3318</p>  <p>R225-7</p>	<p>YEM-H3319</p>  <p>现代管路座</p>	<p>YEM-H3320</p>  <p>4JG1</p>	<p>YEM-H3321</p>  <p>现代210-5 93000机油滤总成</p>
<p>YEM-H3322</p>  <p>DH500机油座</p>	<p>YEM-H3323</p>  <p>DH55机油座</p>	<p>YEM-H3324</p>  <p>住友200-5先导格座</p>	<p>YEM-H3325</p>  <p>住友液压回油座</p>
<p>YEM-H3326</p>  <p>4W6681 2P4004</p>	<p>YEM-H3327</p>  <p>徐工液压管路座</p>	<p>YEM-H3328</p>  <p>VOV360 机油格座</p>	<p>YEM-H3329</p>  <p>VOV480机油格座</p>
<p>YEM-H3330</p>  <p>沃尔沃210</p>	<p>YEM-H3331</p>  <p>沃尔沃机油座</p>	<p>YEM-H3332</p>  <p>三一-215-8机油座</p>	<p>YEM-H3333</p>  <p>4BD1</p>
<p>YEM-H3334</p>  <p>J08机油连接座</p>			

<p>YEM-H3335</p>  <p>卡特307柴油座</p>	<p>YEM-H3336</p>  <p>E325D</p>	<p>YEM-H3337</p>  <p>CAT柴油座带泵 127-02912</p>
<p>YEM-H3338</p>  <p>CAT330CD IR-0762</p>	<p>YEM-H3339</p>  <p>E200B KS568C</p>	<p>YEM-H3340</p>  <p>Ks568新款</p>
<p>YEM-H3341</p>  <p>卡特新款油水座 382-0664</p>	<p>YEM-H3342</p>  <p>卡特320C IR-0750 7N9519</p>	<p>YEM-H3343</p>  <p>E320C新款 IR0751 196-8220</p>
<p>YEM-H3344</p>  <p>卡特200B 145-8862/117-4089</p>	<p>YEM-H3345</p>  <p>卡特320C带泵座 117-4089</p>	<p>YEM-H3346</p>  <p>CAT325B(老款) IR-0751</p>
<p>YEM-H3347</p>  <p>CATD2 360-8958</p>	<p>YEM-H3348</p>  <p>卡特307 9856</p>	<p>YEM-H3349</p>  <p>卡特320C输油板座</p>

柴油格座 FUEL FILTER HEAD

柴油格座 FUEL FILTER HEAD

YEM-H3350



卡特油水分离器座
111-4089(座)

YEM-H3351



卡特0762

YEM-H3352



190-8745柴油泵
326-1644 IR-0770

YEM-H3365



PC360-7油水座

YEM-H3366



PC56-7

YEM-H3367



PC400-7柴油格座
3550

YEM-H3368



1242小

YEM-H3353



卡特1R-0755
422-7587

YEM-H3354



卡特320D输油板座

YEM-H3355



PC200-7 KS590-2

YEM-H3369



FF5052 旧款 OLD

YEM-H3370



FF5052 PC200-6
6D102 3930969新款 NEW

YEM-H3371



PC200-8(6140)

YEM-H3372



PC200-8(3750)

YEM-H3356



PC360-7 KS596-2

YEM-H3357



PC300-7 PC200-6

YEM-H3358



PC200-5
600-311-9640

YEM-H3373



SK460-8

YEM-H3374



SK260-8柴油格座

YEM-H3375



神钢柴油格座
1242 3孔

YEM-H3376



神钢柴油格座(带泵)

YEM-H3359



PC400-7
3550

YEM-H3360



PC200-3
KS101F

YEM-H3361



PC200-6
FF5052

YEM-H3377



SK60 MB220900

YEM-H3378



斗山柴油双座

YEM-H3379



DH215-9

YEM-H3380



DH220-5
FS1212

YEM-H3362



PC400-7
4510 柴油格座

YEM-H3363



FS1242

YEM-H3364



Fs1242 三孔

YEM-H3381



R90P
SK-8/VOLVO

YEM-H3382



0749柴油格座

YEM-H3383



R60P/R90P/R120P

YEM-H3384



现代215-7双座

柴油格座 FUEL FILTER HEAD

柴油格座 FUEL FILTER HEAD

<p>YEM-H3385</p>  <p>日立450/330</p>	<p>YEM-H3386</p>  <p>EX200-5/6BG1 KS569</p>	<p>YEM-H3387</p>  <p>Ex200 KS570C</p>	<p>YEM-H3388</p>  <p>新款沃尔沃210</p>	
<p>YEM-H3389</p>  <p>沃尔沃210(老款)</p>	<p>YEM-H3390</p>  <p>105双杯</p>	<p>YEM-H3391</p>  <p>3TNV84 129004-42040</p>	<p>YEM-H3392</p>  <p>洋马4TNV94/98</p>	
<p>YEM-H3393</p>  <p>三一-570</p>	<p>YEM-H3394</p>  <p>三一-465柴油座</p>	<p>YEM-H3395</p>  <p>三一新款柴油座</p>	<p>YEM-H3396</p>  <p>三一-215C-9柴油座</p>	
<p>YEM-H3397</p>  <p>三一/日立450柴油格座</p>	<p>YEM-H3398</p>  <p>加藤1430柴油座</p>	<p>YEM-H3399</p>  <p>FS1280/FF5052 3905491 连体</p>	<p>YEM-H3400</p>  <p>4JG1/ZX70</p>	
<p>YEM-H3401</p>  <p>568L新款柴油格座</p>	<p>YEM-H3402</p>  <p>371-3599电子燃油泵 326-1644 IR-0770</p>	<p>YEM-H3403</p>  <p>220900</p>	<p>YEM-H3404</p>  <p>19594</p>	<p>YEM-H3405</p>  <p>E320C输油铝板座</p>

<p>YEM-H3406</p>  <p>柳工926E FF63009</p>	<p>YEM-H3407</p>  <p>IR-0770</p>	<p>YEM-H3408</p>  <p>PC200-8手油泵 6754-71-7200</p>	<p>YEM-H3409</p>  <p>PC60-8 4120</p>
<p>YEM-H3410</p>  <p>Ff1098柴油手压泵</p>	<p>YEM-H3411</p>  <p>R90P手压泵</p>	<p>YEM-H3412</p>  <p>PC240-8手油泵 600-3195610</p>	<p>YEM-H3413</p>  <p>现代215-7手油泵 连接螺纹20X1.5</p>
<p>YEM-H3414</p>  <p>SK130-8 连接螺纹1-14牙</p>	<p>YEM-H3415</p>  <p>PC60-8 5910</p>	<p>YEM-H3416</p>  <p>PC400-7手油泵</p>	<p>YEM-H3417</p>  <p>1R-0749 1N-3789</p>
<p>YEM-H3418</p>  <p>DH225-9油水座</p>	<p>YEM-H3419</p>  <p>沃尔沃210手油泵带开关</p>	<p>YEM-H3420</p>  <p>沃尔沃210手油泵</p>	<p>YEM-H3421</p>  <p>沃尔沃460</p>
<p>YEM-H3422</p>  <p>沃尔沃360连体座</p>	<p>YEM-H3423</p>  <p>沃尔沃进水控制板</p>	<p>YEM-H3424</p>  <p>沃尔沃460</p>	<p>YEM-H3425</p>  <p>沃尔沃460</p>





















节温器座 SEAT THERMOSTAT

<p>YEM-H3426</p>  <p>PC200-5 6D95 节温器上座 6204-11-6430 Seat thermostat</p>	<p>YEM-H3427</p>  <p>PC200-3节温器上座 Seat thermostat</p>	<p>YEM-H3428</p>  <p>PC200-3节温器下座 6136-11-6411 Seat thermostat</p>	<p>YEM-H3429</p>  <p>PC100-5</p>	<p>YEM-H3430</p>  <p>新款 B 旧款 4BD1上座 Seat thermostat B:8-94401753-1</p>
<p>YEM-H3431</p>  <p>PC45-7/4D84节温器座 Seat thermostat</p>	<p>YEM-H3432</p>  <p>PC200-6/6D95节温器座 Seat thermostat</p>	<p>YEM-H3433</p>  <p>4BD1下座 8-94462553-0 Seat thermostat</p>	<p>YEM-H3434</p>  <p>E320 E200B节温器上下座 Seat thermostat</p>	<p>YEM-H3435</p>  <p>CAT直 CAT弯 上座</p>
<p>YEM-H3436</p>  <p>6BD1节温器上座 8-97138003-2 Seat thermostat</p>	<p>YEM-H3437</p>  <p>6BD1节温器下座 8-94310491-3 Seat thermostat</p>	<p>YEM-H3438</p>  <p>ZAX上座 Seat thermostat</p>	<p>YEM-H3439</p>  <p>ZAX下座 5-13716026-0 Seat thermostat</p>	<p>YEM-H3440</p>  <p>6HK1节温器座 8-94390520-1 Seat thermostat</p>
<p>YEM-H3441</p>  <p>SK200 SK200-2/3 6D31下座 Seat thermostat</p>	<p>YEM-H3442</p>  <p>Sk200 SK200-2/3 6D31上座 Seat thermostat</p>	<p>YEM-H3443</p>  <p>W120,6D110节温器座</p>	<p>YEM-H3444</p>  <p>洋马节温器座直 Seat thermostat</p>	<p>YEM-H3445</p>  <p>洋马节温器座弯 Seat thermostat</p>
<p>YEM-H3446</p>  <p>4JG1 节温器座</p>	<p>YEM-H3447</p>  <p>4D88直 4TNV94弯</p>	<p>YEM-H3448</p>  <p>HD450节温器座</p>	<p>YEM-H3449</p>  <p>DH220-3节温器 65.06401-6049 Seat thermostat</p>	<p>YEM-H3450</p>  <p>DH300-5节温器 65.06401-6040 Seat thermostat</p>

节温器 THERMASTAT

<p>YEM-H3451</p>  <p>PC200-3 6D105 600-421-6210</p>	<p>YEM-H3452</p>  <p>PC200-5 6D95 600-421-6120/600-421-6110</p>	<p>YEM-H3453</p>  <p>PC200-6 6D95 600-421-6360</p>	<p>YEM-H3454</p>  <p>PC200-6/7 6D102 6735-61-6471 6732-61-1620</p>	<p>YEM-H3455</p>  <p>6D107 PC200-8节温器</p>
<p>YEM-H3456</p>  <p>6D108 600-421-6410</p>	<p>YEM-H3457</p>  <p>4D102节温器</p>	<p>YEM-H3458</p>  <p>PC300-3 PC400-3/5/6 6D125 600-421-6310</p>	<p>YEM-H3459</p>  <p>PC360-7 6D114 3902526 6741-61-1610</p>	<p>YEM-H3460</p>  <p>PC400-7 600-421-6630</p>
<p>YEM-H3461</p>  <p>4BD1 8-94472331-1 8-13770-0301-1</p>	<p>YEM-H3462</p>  <p>6BD1 1-1370-070-0</p>	<p>YEM-H3463</p>  <p>4HK1 8-97300790-2 8-97300787-2</p>	<p>YEM-H3464</p>  <p>6HK1 8-97602393-1-2 8-97602048-2</p>	<p>YEM-H3465</p>  <p>H07CT</p>
<p>YEM-H3466</p>  <p>S6K 5I-8010</p>	<p>YEM-H3467</p>  <p>E330 248-5513</p>	<p>YEM-H3468</p>  <p>EC360 节温器</p>	<p>YEM-H3469</p>  <p>6D31 6D34 Me996365/ME999307</p>	<p>YEM-H3470</p>  <p>6D14 60小 ME994276</p>
<p>YEM-H3471</p>  <p>DH60/R60 节温器</p>	<p>YEM-H3472</p>  <p>DH300 节温器</p>	<p>YEM-H3473</p>  <p>DH220-5 节温器</p>	<p>YEM-H3474</p>  <p>4JG1 节温器</p>	<p>YEM-H3475</p>  <p>3928639 3940632 R300 6CT</p>
<p>YEM-H3476</p>  <p>4D84 4D88</p>	<p>YEM-H3477</p>  <p>4TNV94 4TNV88</p>	<p>YEM-H3478</p>  <p>VOLVO</p>	<p>YEM-H3479</p>  <p>J05 SK200-8 J08 SK350-8</p>	<p>YEM-H3480</p>  <p>EC480节温器</p>

<p>YEM-H3481</p>  <p>PC40 直径400/440</p>	<p>YEM-H3482</p>  <p>PC60/PC100 4D95</p>	<p>YEM-H3483</p>  <p>PC120-6 4D102</p>	<p>YEM-H3484</p>  <p>PC40 10叶</p>
<p>YEM-H3485</p>  <p>PC450-8</p>	<p>YEM-H3486</p>  <p>PC200-3 6D105</p>	<p>YEM-H3487</p>  <p>PC200-5 6D95</p>	<p>YEM-H3488</p>  <p>PC200-6 6D102</p>
<p>YEM-H3489</p>  <p>PC300-6 PC400-6 6D108正方向</p>	<p>YEM-H3490</p>  <p>PC300-7 PC400-7</p>	<p>YEM-H3491</p>  <p>PC WA380-3</p>	<p>YEM-H3492</p>  <p>PC120 4D95 8叶</p>
<p>YEM-H3493</p>  <p>PC300-6/PC400-6/6D125</p>	<p>YEM-H3494</p>  <p>PC-8 6D102 11叶</p>	<p>YEM-H3495</p>  <p>PC60/PC120 4D95 10叶</p>	<p>YEM-H3496</p>  <p>PC130</p>
<p>YEM-H3497</p>  <p>Pc60/PC120 4D95 8叶</p>	<p>YEM-H3498</p>  <p>Pc30 6叶</p>	<p>YEM-H3499</p>  <p>PC30 7叶</p>	<p>YEM-H3500</p>  <p>EX60-1 4JB1 4孔</p>

<p>YEM-H3501</p>  <p>EX120-5 4BG1 7叶</p>	<p>YEM-H3502</p>  <p>EX120 4BG1 8叶</p>	<p>YEM-H3503</p>  <p>EX120-6/ZAX120 4BG1 8叶</p>	<p>YEM-H3504</p>  <p>EX120/4BD1</p>
<p>YEM-H3505</p>  <p>EX/SK/SH 4BD1 8叶</p>	<p>YEM-H3506</p>  <p>EX200-2-3 6BD1</p>	<p>YEM-H3507</p>  <p>EX200 6BD1 10叶</p>	<p>YEM-H3508</p>  <p>EX200-5 6BG1</p>
<p>YEM-H3509</p>  <p>EX300-2 6SD1</p>	<p>YEM-H3510</p>  <p>EX H06CT</p>	<p>YEM-H3511</p>  <p>EX H07CT</p>	<p>YEM-H3512</p>  <p>EX350-3/6HK1</p>
<p>YEM-H3513</p>  <p>ZAX200-6/6BG1</p>	<p>YEM-H3514</p>  <p>ZAX230-3 240-3 4HK1</p>	<p>YEM-H3515</p>  <p>CAT320/CAT320B S6K 6叶</p>	<p>YEM-H3516</p>  <p>CAT200B/CAT320 S6K 7叶</p>
<p>YEM-H3517</p>  <p>CAT320C</p>	<p>YEM-H3518</p>  <p>CAT 320D 127</p>	<p>YEM-H3519</p>  <p>CAT 320D</p>	<p>YEM-H3520</p>  <p>CAT320/200B S6K 10叶</p>

风叶系列 FAN COOLING















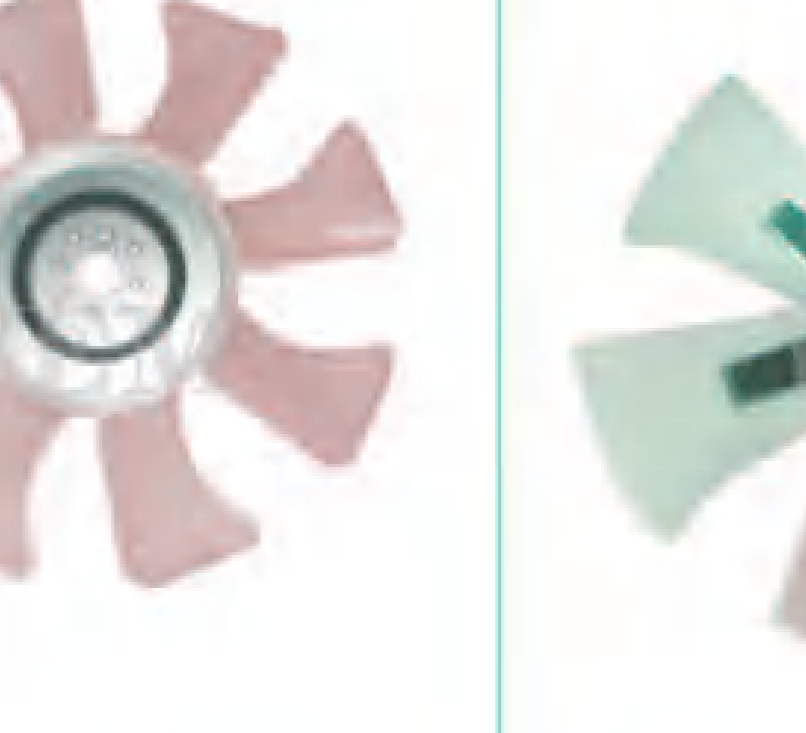
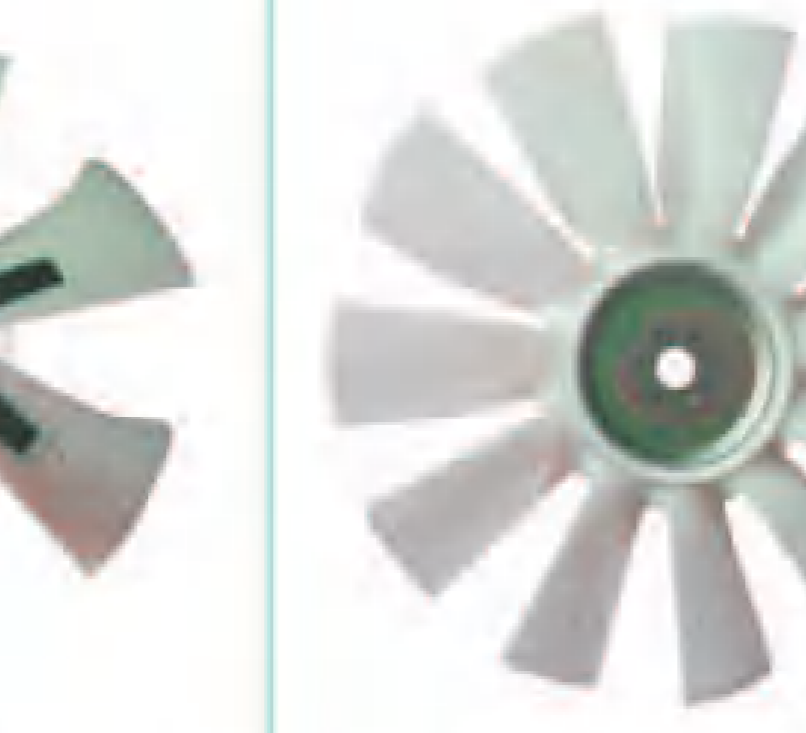



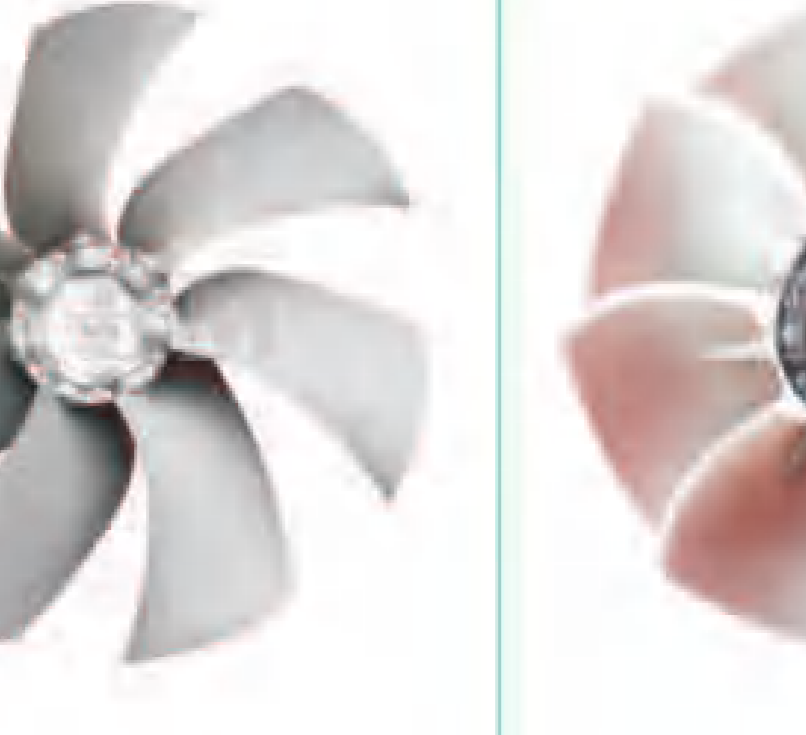
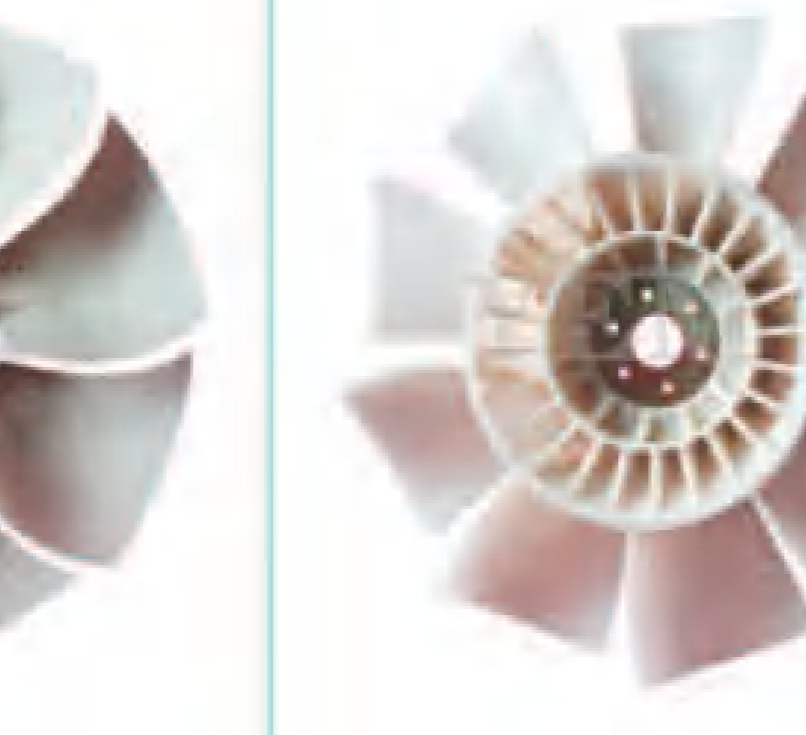

<p>YEM-H3521</p>  <p>CAT320 S6K 6叶</p>	<p>YEM-H3522</p>  <p>CAT307B 4M40</p>	<p>YEM-H3523</p>  <p>SK300 6D22</p>	<p>YEM-H3524</p>  <p>SK200-8/SK250-8 J05</p>
<p>YEM-H3525</p>  <p>SK/SH/HD 4JB1 10叶</p>	<p>YEM-H3526</p>  <p>SK/HD S6K-6D34-6</p>	<p>YEM-H3527</p>  <p>SK300 6D22-6D34-8</p>	<p>YEM-H3528</p>  <p>SK200-6 6D31-6D34-7</p>
<p>YEM-H3529</p>  <p>SK230-6 6D102-6D34-9</p>	<p>YEM-H3530</p>  <p>DH55 FD33 SK60/SK120 4JB1 8叶</p>	<p>YEM-H3531</p>  <p>DH100-5-7 6D31</p>	<p>YEM-H3532</p>  <p>DH220-3</p>
<p>YEM-H3533</p>  <p>DH220-5</p>	<p>YEM-H3534</p>  <p>DH280-3</p>	<p>YEM-H3535</p>  <p>HD S4F</p>	<p>YEM-H3536</p>  <p>HD400.450 510.512 4D31</p>
<p>YEM-H3537</p>  <p>HD700 6D31 10叶</p>	<p>YEM-H3538</p>  <p>HD800 6D14</p>	<p>YEM-H3539</p>  <p>HD1430 6D24 10叶</p>	<p>YEM-H3540</p>  <p>HD512 4D31 9叶</p>

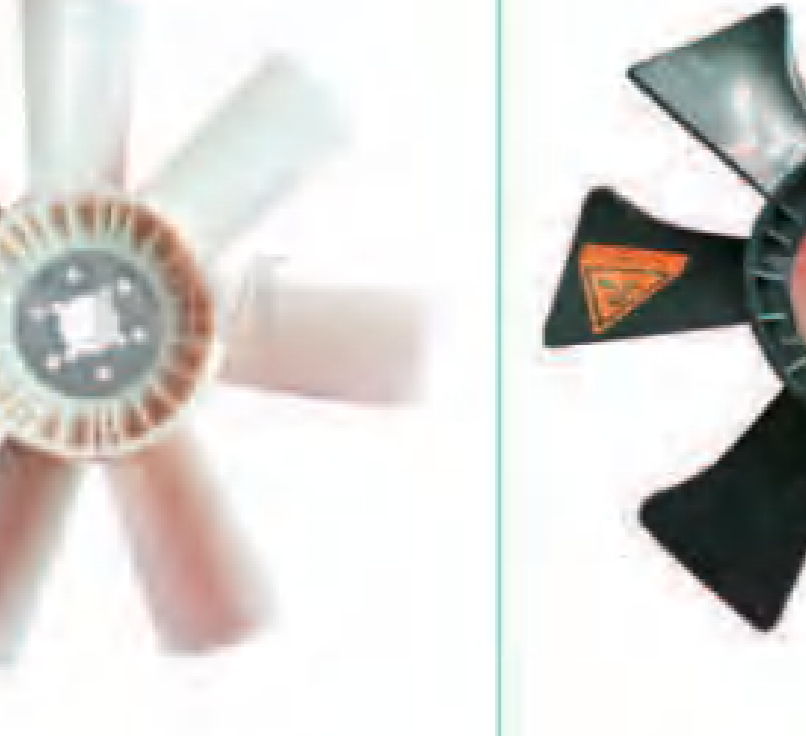
风叶系列 FAN COOLING

<p>YEM-H3541</p>  <p>HD1250 6D22 30948-80400</p>	<p>YEM-H3542</p>  <p>HD308 430-13.8-153-4T8</p>	<p>YEM-H3543</p>  <p>R80 4TNV94/98</p>	<p>YEM-H3544</p>  <p>R130</p>
<p>YEM-H3545</p>  <p>R200</p>	<p>YEM-H3546</p>  <p>R02005</p>	<p>YEM-H3547</p> 	<p>YEM-H3548</p>  <p>R210-5</p>
<p>YEM-H3549</p>  <p>R455</p>	<p>YEM-H3550</p>  <p>VOLVO210</p>	<p>YEM-H3551</p>  <p>VOLVO240</p>	<p>YEM-H3552</p>  <p>VOLVO360</p>
<p>YEM-H3553</p>  <p>铅 760-82-96-4T8 480-82-96-4T8 VOLVO</p>	<p>YEM-H3554</p>  <p>VOLVO 480</p>	<p>YEM-H3555</p>  <p>VOLVO 360 新款</p>	<p>YEM-H3556</p>  <p>VOLVO 750-76-134-6T8</p>
<p>YEM-H3557</p>  <p>VOLVO 930-76-134</p>	<p>YEM-H3558</p>  <p>SH280 580-4孔-6叶</p>	<p>YEM-H3559</p>  <p>SH240 4HK1</p>	<p>YEM-H3560</p>  <p>久保田 450-22-54-4T7</p>

风叶系列 FAN COOLING

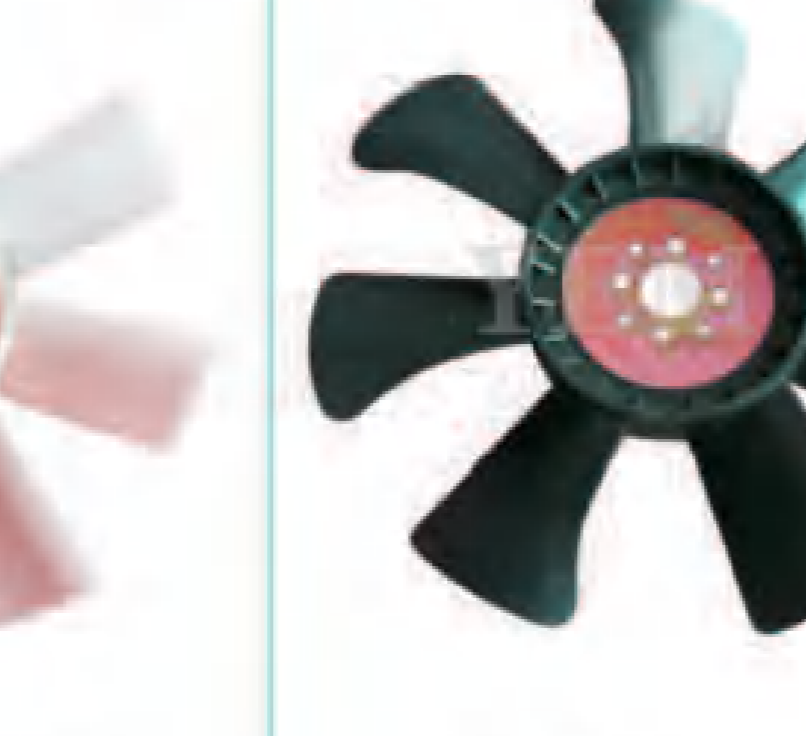
空滤总成 AIR FILTER ASS'Y
后盖 FITER COVER

<p>YEM-H3561</p>  <p>久保田 400-24-40-51-8T8</p>	<p>YEM-H3562</p>  <p>洋马 4TNV88-28</p>	<p>YEM-H3563</p>  <p>洋马 4TNV88-24</p>	<p>YEM-H3564</p>  <p>洋马 10叶</p>	
<p>YEM-H3565</p>  <p>6D16 正/反</p>	<p>YEM-H3566</p>  <p>4LE1</p>	<p>YEM-H3567</p>  <p>1150-108-128-4T6-6T6</p>	<p>YEM-H3568</p>  <p>790-51-89-6T11</p>	<p>YEM-H3569</p>  <p>徐工 60/80</p>
<p>YEM-H3570</p>  <p>560-75-96-4T12</p>	<p>YEM-H3571</p>  <p>柳工 正/反</p>	<p>YEM-H3572</p>  <p>JCM360</p>	<p>YEM-H3573</p>  <p>三一-215-8</p>	<p>YEM-H3574</p>  <p>三一重工 470-160-177-4T7</p>
<p>YEM-H3575</p>  <p>柳工 1040-25-60 正/反</p>	<p>YEM-H3576</p>  <p>590-51-89-6T7 反</p>	<p>YEM-H357</p>  <p>370-28-52-4T7 反</p>	<p>YEM-H3578</p>  <p>400-28-52-4T6 反</p>	<p>YEM-H3579</p>  <p>53.5-42-64-4T11 反</p>
<p>YEM-H3580</p>  <p>390-24-40-4T6 反</p>	<p>YEM-H3581</p>  <p>490-42-64-4T7 反</p>	<p>YEM-H3582</p>  <p>560-43-60-4T7 反</p>	<p>YEM-H3583</p>  <p>370-32-54-4T7 反</p>	<p>YEM-H3584</p>  <p>6D102风叶圈罩</p>

<p>YEM-H3585</p>  <p>CAT312D</p>	<p>YEM-H3586</p>  <p>CAT320C 162-6201</p>	<p>YEM-H3587</p>  <p>CAT320B/D</p>	<p>YEM-H3588</p>  <p>CAT330/330BC/325L 193-2714</p>
<p>YEM-H3589</p>  <p>CAT336D总成</p>	<p>YEM-H3590</p>  <p>PC200-7</p>	<p>YEM-H3591</p>  <p>PC220-7/PC200-8 6738-81-7200</p>	<p>YEM-H3592</p>  <p>PC300-6总成</p>
<p>YEM-H3593</p>  <p>PC450</p>	<p>YEM-H3594</p>  <p>EX230-6/EX200-5 EX240/EX250 443061</p>	<p>YEM-H3595</p>  <p>EX200-2/SH200-1</p>	<p>YEM-H3596</p>  <p>EX300-3总成</p>
<p>YEM-H3597</p>  <p>EX330</p>	<p>YEM-H3598</p>  <p>SK总成 EX200-5</p>	<p>YEM-H3599</p>  <p>SK350-8</p>	<p>YEM-H3600</p>  <p>SK60弯头</p>
<p>YEM-H3601</p>  <p>R215-7/R225-7</p>	<p>YEM-H3602</p>  <p>DH220-5</p>	<p>YEM-H3603</p>  <p>4TNV94</p>	<p>YEM-H3604</p>  <p>加藤820</p>

空滤总成 AIR FILTER ASS'Y
后盖 FITER COVER

柴油箱滤网 FUEL TANK STRAINER

<p>YEM-H3605</p>  <p>PC200-7后盖</p>	<p>YEM-H3606</p>  <p>EX200-5后盖</p>	<p>YEM-H3607</p>  <p>洋马后盖</p>	<p>YEM-H3608</p>  <p>EX200-1/2 SK200-5/6 SH200 空气滤清器盖</p>	<p>YEM-H3609</p>  <p>CAT320B/D/C EX230-6/240/250 R225-7/210-8 PC220-7/200-8 空气滤清器盖</p>
<p>YEM-H3610</p>  <p>PC450/EX450 PC360/EX330 VOLVO360/460 VOLVO240/SK350-8 CAT330/329空气滤清器盖</p>	<p>YEM-H3611</p>  <p>φ102mm 4" R55 预滤器</p>	<p>YEM-H3612</p>  <p>φ78mm 3" R210-7 预滤器</p>	<p>YEM-H3613</p>  <p>φ178mm 7" SK350-8 预热器</p>	<p>YEM-H3614</p>  <p>φ127mm 5" SK200-8 预滤器</p>
<p>YEM-H3615</p>  <p>5" SK200-8 预滤器(铝)</p>	<p>YEM-H3616</p>  <p>φ150mm 6" PC300-7 预热器</p>	<p>YEM-H3617</p>  <p>4" 预滤器透明罩</p>	<p>YEM-H3618</p>  <p>3" 预滤器透明罩</p>	<p>YEM-H3619</p>  <p>5" 预滤器透明罩</p>
<p>YEM-H3620</p>  <p>6" 预滤器透明罩</p>	<p>YEM-H3621</p>  <p>7" 预滤器透明罩</p>	<p>YEM-H3622</p>  <p>φ63 预滤器</p>	<p>YEM-H3623</p>  <p>φ57 预滤器</p>	<p>YEM-H3624</p>  <p>EX100/120 φ78 预滤器</p>
<p>YEM-H3625</p>  <p>EX200-1 φ105 预滤器</p>	<p>YEM-H3626</p>  <p>EX60-1 φ65 预滤器</p>	<p>YEM-H3627</p>  <p>1000芯</p>	<p>YEM-H3628</p>  <p>900芯</p>	<p>YEM-H3629</p>  <p>500芯</p>
<p>YEM-H3625</p>  <p>DX预滤器</p>	<p>YEM-H3626</p>  <p>1000芯</p>	<p>YEM-H3627</p>  <p>900芯</p>	<p>YEM-H3628</p>  <p>500芯</p>	<p>YEM-H3629</p>  <p>DX预滤器</p>

<p>YEM-H3630</p>  <p>SH住友/日立 沃尔沃 4121496</p>	<p>YEM-H3631</p>  <p>CAT320 18416/07056-18416</p>	<p>YEM-H3632</p>  <p>R胶</p>	<p>YEM-H3633</p>  <p>R胶</p>	<p>YEM-H3634</p>  <p>PC200-7</p>
<p>YEM-H3635</p>  <p>Dh300</p>	<p>YEM-H3636</p>  <p>A:ZAX B: HITACHI 日立 液压油滤网</p>	<p>YEM-H3637</p>  <p>PC不锈钢</p>	<p>YEM-H3638</p>  <p>PC30/40不锈钢滤网</p>	<p>YEM-H3639</p>  <p>PC-7不锈钢</p>
<p>YEM-H3640</p>  <p>PC-8不锈钢</p>	<p>YEM-H3641</p>  <p>ZAX不锈钢滤网</p>	<p>YEM-H3642</p>  <p>EX不锈钢滤网</p>	<p>YEM-H3643</p>  <p>SK-8不锈钢滤网</p>	<p>YEM-H3644</p>  <p>R不锈钢滤网</p>
<p>YEM-H3645</p>  <p>320C不锈钢滤网</p>	<p>YEM-H3646</p>  <p>DH不锈钢滤网</p>	<p>YEM-H3647</p>  <p>手油泵网 (A:胶 B: 铜)</p>	<p>YEM-H3648</p>  <p>A:防滑砂纸 B: 液压泵滤网 C:小铜网</p>	

油水分离器系列 OIL-WATER SERIES

油水分离器系列 OIL-WATER SERIES

YEM-H3649



MST-7020
1000FH

YEM-H3650



MST-7021
1000FG

YEM-H3651



MST-7022
900FG

YEM-H3652



MST-7027
500FG

YEM-H3653



Fs20019
MP8288总成

YEM-H3654



Fs19728
MP8149总成

YEM-H3655



MST-7023
900FG(铁)

YEM-H3656



130306380
帕金斯

YEM-H3657



MST-7013
141粗滤器

YEM-H3658



MST-7014
4676385总成

YEM-H3659



MST-7015
4679981总成

YEM-H3660



MST-7016
4642641总成

YEM-H3661



MST-7018
SK-6/6E油水总成

YEM-H3662



MST-7028
帕金斯, 4132A016
2656163

YEM-H3663



MST-7029
帕金斯, 4132A014
2650201

YEM-H3664



卡特新款电子油泵

YEM-H3665



FSC63-09总成
FF63009

YEM-H3666



PC56-7
久保田油水总成

YEM-H3667



MST-7030
TB1135油水分离器

YEM-H3668



MST-7031
洋马油水分离器

YEM-H3669



MST-7033
EX油水分离器

YEM-H3670



MST-7034
PC-7油水分离器

YEM-H3671



MST-7035
SY老款油水分离器

YEM-H3672



MST-7036
R215-7油水分离器

YEM-H3673



MST-7037
R油水分离器

YEM-H3674



MST-7038
PC油水分离器(铁芯)

YEM-H3675



新洋马油水分离器总成

YEM-H3676



洋马油水分离器(直管M8)

YEM-H3677



MP898-2总成

YEM-H3678



MP899油水总成(国产机专用)

YEM-H3679



三一新款油水分离器总成

YEM-H3680



DX55-9C专用油水分离器

YEM-H3681



卡特D2油水分离器
368-3976 360-8959

YEM-H3682



卡特柴油滤总成
360-8958

YEM-H3683



FS19925总成

YEM-H3684













油水分离器总成

油水分离器系列 OIL-WATER SERIES

油水分离器杯 Oil sep cup

<p>YEM-H3685</p>  <p>旋挖钻管路回油总成</p>	<p>YEM-H3686</p>  <p>三一215-10油水分离器总成</p>	<p>YEM-H3687</p>  <p>油水分离器总成</p>	<p>YEM-H3688</p>  <p>破碎锤液压滤总成 (含支架、管头、滤芯)</p>	
<p>YEM-H3689</p>  <p>360-8960总成</p>	<p>YEM-H3690</p>  <p>五十铃泵车新款油水分离器</p>	<p>YEM-H3691</p>  <p>MP8327总成</p>	<p>YEM-H3692</p>  <p>PC-8MO 油水分离器全套</p>	
<p>YEM-H3693</p>  <p>ZAX70先导格座</p>	<p>YEM-H3694</p>  <p>MST-7041 EX先导总成</p>	<p>YEM-H3695</p>  <p>EX(P807)新款</p>	<p>YEM-H3696</p>  <p>EX200-5(SP807) 先导格座</p>	
<p>YEM-H3697</p>  <p>MP8220总成 360-8960</p>	<p>YEM-H3698</p>  <p>MP8220外壳 360-8960</p>	<p>YEM-H3699</p>  <p>MST-7039 MP806先导总成</p>	<p>YEM-H3700</p>  <p>MST-7040 R/DH先导总成</p>	<p>YEM-H3701</p>  <p>现代</p>
<p>YEM-H3702</p>  <p>卡特(806)</p>	<p>YEM-H3703</p>  <p>大宇</p>	<p>YEM-H3704</p>  <p>SK200-6E先导格座</p>	<p>YEM-H3705</p>  <p>DH300先导格座</p>	<p>YEM-H3706</p>  <p>11172907总成</p>

<p>YEM-H3707</p>  <p>OEM:R60T/R90T/R120T</p>	<p>YEM-H3708</p>  <p>OEM:0770/0771</p>	<p>YEM-H3709</p>  <p>OEM:490 117-4089</p>	<p>YEM-H3710</p>  <p>OEM:PERKINS 117-4089</p>	
<p>YEM-H3711</p>  <p>OEM:SCANIA</p>	<p>YEM-H3712</p>  <p>OEM:612630080205背带加热</p>	<p>YEM-H3713</p>  <p>OEM:R20P R120P</p>	<p>YEM-H3714</p>  <p>OEM:BENZ</p>	
<p>YEM-H3715</p>  <p>OEM:R60P/R90P/R120P HEATER</p>	<p>YEM-H3716</p>  <p>OEM:PL420带线</p>	<p>YEM-H3717</p>  <p>FS1242带感应积水杯</p>	<p>YEM-H3718</p>  <p>OEM:R120P 1335673 129-0373</p>	
<p>YEM-H3719</p>  <p>OEM:PL420</p>	<p>YEM-H3720</p>  <p>OEM:500FG</p>	<p>YEM-H3721</p>  <p>OEM:900FG</p>	<p>YEM-H3722</p>  <p>OEM:1000FG</p>	
<p>YEM-H3723</p>  <p>OEM:600P ST386</p>	<p>YEM-H3724</p>  <p>OEM:PL420 HEATER</p>	<p>YEM-H3725</p>  <p>神钢 200-6E</p>	<p>YEM-H3726</p>  <p>OEM:神钢</p>	<p>YEM-H3727</p>  <p>OEM:FS1242</p>

YEM-H3728



电脑版CONTROLLER
PC200-5(小板)
7324-32-1100

YEM-H3729



电脑版(大板)
CONTROLLER
PC200-5

YEM-H3730



电脑版CONTROLLER
PC200-6/6D95(小板)
7834-32-3000

YEM-H3743



电脑版CONTROLLER
SK200-2
YN22E00015F3

YEM-H3744



显示屏电脑版
CONTROLLER
SK-2

YEM-H3745



电脑版CONTROLLER
SK230-6
YN22E00123F4

YEM-H3731



电脑版CONTROLLER
PC200-6/6D95(大板)
7834-10-2000

YEM-H3732



电脑版CONTROLLER
PC200-6/6D102
7834-21-6002

YEM-H3733



电脑版CONTROLLER
PC-6手拉油门电脑版
7834-27-2002

YEM-H3746



电脑版CONTROLLER
SK200-6E

YEM-H3747



电脑版CONTROLLER
E200-B

YEM-H3748



电脑版CONTROLLER
CAT 320
119-0609X-00

YEM-H3734



电脑版CONTROLLER
PC200-7
7835-26-1009

YEM-H3735



PC200-8电脑版

YEM-H3736



电脑版CONTROLLER
EX200-5(合肥板)
4372490

YEM-H3749



电脑版CONTROLLER
CAT 320D
211-8874-03

YEM-H3750



卡特C9电脑版

YEM-H3751



电脑版CONTROLLER
HD820-3(大板)
119-0609X-00

YEM-H3737



电脑版CONTROLLER
EX200-2(小板)
9104912

YEM-H3738



电脑版CONTROLLER
EX200-2(大板)

YEM-H3739



电脑版CONTROLLER
ZAXIS200-1(直喷)

YEM-H3752



电脑版(小板继电器)
CONTROLLER
KATO HD820-3

YEM-H3753



电脑版CONTROLLER
DH225-V/7 DH300-7
543-00055A

YEM-H3754



电脑版CONTROLLER
DH220-5

YEM-H3740



ZAX200-1小板(直喷)
9239568

YEM-H3741



电脑版(小板)
CONTROLLER
ZAX230-3

YEM-H3742



电脑版(电喷)
CONTROLLER (big)
ZAXIS

YEM-H3755



电脑版CONTROLLER
DH225-7(小板)
543-00074

YEM-H3756



油门驱动板
住友小板 SH A1/A2
KHR1347

YEM-H3757



电脑版
CONTROLLER
SH200A1/A2

YEM-H3758



电脑版
CONTROLLER
R220-5

YEM-H3759



电脑版
CONTROLLER
R225-7/R290-7电脑版

YEM-H3760



电脑版CONTROLLER
VOLVO 1459-4697

YEM-H3761



电脑版CONTROLLER
VOLVO 210/240/290/360

YEM-H3762



J05/J08检测仪
09993-E9070

YEM-H3763



电脑版CONTROLLER
317-7485

YEM-H3764



ZX-3 检测仪

YEM-H3765



ISUZU 检测仪

YEM-H3766



PC200-8发动机板
600-467-1100
4921776

YEM-H3767



ECU-2000控制器

YEM-H3768



EPEC控制器

YEM-H3769



GPS卫星定位跟踪器组件

YEM-H3770



保险盒控制单元

YEM-H3771



步进电机驱动器

YEM-H3772



川崎控制器

YEM-H3773



阀门控制器

YEM-H3774



发动机控制器

YEM-H3775



控制器

YEM-H3776



控制器

YEM-H3777



控制器

YEM-H3778



控制器

YEM-H3779



控制器

YEM-H3780



控制器

YEM-H3781



三一控制器

YEM-H3782



三一控制器

YEM-H3783



龙工控制器

YEM-H3784



油门控制器

YEM-H3785



直流电机控制器

YEM-H3786



直流电机控制器

YEM-H3787



柳工开关盒总成

显示器系列 MONITOR

显示器系列 MONITOR

<p>YEM-H3788</p>  <p>显示屏 MONITOR PC60-7</p>	<p>YEM-H3789</p>  <p>显示屏 MONITOR PC200-5</p>	<p>YEM-H3790</p>  <p>显示屏 MONITOR PC200-6/6D95 7834-70-6003/7834-77-3002</p>	<p>YEM-H3791</p>  <p>显示屏 MONITOR PC200-6/6D102 7834-70-3001/7834-72-4002</p>
<p>YEM-H3792</p>  <p>显示屏 MONITOR PC200-7 7835-12-3007/7835-12-3000</p>	<p>YEM-H3793</p>  <p>7835-102005 (三模式) 7835-10-5000 (回模式)</p> <p>显示屏 MONITOR PC130-7</p>	<p>YEM-H3794</p>  <p>显示屏 MONITOR CAT320B</p>	<p>YEM-H3795</p>  <p>显示屏 MONITOR CAT320C</p>
<p>YEM-H3796</p>  <p>卡特C9显示器</p>	<p>YEM-H3797</p>  <p>ZAX330-3</p>	<p>YEM-H3798</p>  <p>大字DH-60显示器</p>	<p>YEM-H3799</p>  <p>大字DH-80显示器</p>
<p>YEM-H3800</p>  <p>显示屏 MONITOR DH225-7</p>	<p>YEM-H3801</p>  <p>显示屏 MONITOR HD820</p>	<p>YEM-H3802</p>  <p>VOLVO</p>	<p>YEM-H3803</p>  <p>SK神钢显示器</p>
<p>YEM-H3804</p>  <p>显示屏 MONITOR SK200-3/5</p>	<p>YEM-H3805</p>  <p>SK200-6E显示器</p>	<p>YEM-H3806</p>  <p>显示屏 MONITOR SK-2</p>	

<p>YEM-H3807</p>  <p>显示屏 MONITOR 三一重工</p>	<p>YEM-H3808</p>  <p>三一显示屏</p>	<p>YEM-H3809</p>  <p>三一显示屏</p>
<p>YEM-H3810</p>  <p>柳工显示屏</p>	<p>YEM-H3811</p>  <p>柳工显示屏</p>	<p>YEM-H3812</p>  <p>柳工显示屏</p>
<p>YEM-H3813</p>  <p>柳工显示屏</p>	<p>YEM-H3814</p>  <p>徐工显示屏</p>	<p>YEM-H3815</p>  <p>柳工显示屏</p>
<p>YEM-H3816</p>  <p>柳工显示屏</p>	<p>YEM-H3817</p>  <p>柳工显示屏</p>	<p>YEM-H3818</p>  <p>徐工显示屏</p>
<p>YEM-H3819</p>  <p>徐工显示屏</p>	<p>YEM-H3820</p>  <p>徐工显示屏</p>	<p>YEM-H3821</p>  <p>徐工显示屏</p>

<p>YEM-H3822</p>  <p>DX260监视器</p>	<p>YEM-H3823</p>  <p>徐工显示屏</p>	<p>YEM-H3824</p>  <p>玉柴显示屏</p>	<p>YEM-H3825</p>  <p>玉柴显示屏</p>	
<p>YEM-H3826</p>  <p>玉柴显示屏</p>	<p>YEM-H3827</p>  <p>玉柴显示屏</p>	<p>YEM-H3828</p>  <p>中联显示屏</p>	<p>YEM-H3829</p>  <p>中联显示屏</p>	
<p>YEM-H3830</p>  <p>中联显示屏</p>	<p>YEM-H3831</p>  <p>中联显示屏</p>	<p>YEM-H3832</p>  <p>力士德显示屏</p>	<p>YEM-H3833</p>  <p>力士德显示屏</p>	
<p>YEM-H3834</p>  <p>厦工显示屏</p>	<p>YEM-H3835</p>  <p>龙工显示屏</p>	<p>YEM-H3836</p>  <p>福田雷沃显示屏</p>	<p>YEM-H3837</p>  <p>开元显示屏</p>	
<p>YEM-H3838</p>  <p>三栋临工显示屏</p>	<p>YEM-H3839</p>  <p>华力显示屏</p>	<p>YEM-H3840</p>  <p>柳工显示仪表</p>	<p>YEM-H3841</p>  <p>国机重工显示屏</p>	
		<p>YEM-H3842</p>  <p>PC200-8监视器</p>		

<p>YEM-H3843</p>  <p>液晶片 LCD PC200-6/6D95 双时间 Double Time</p>	<p>YEM-H3844</p>  <p>液晶片 LCD PC200-6/6D102</p>	<p>YEM-H3845</p>  <p>液晶片 LCD PC200-6/6D95 单时间 Single Time</p>	<p>YEM-H3846</p>  <p>油量水温显示液晶片 PC手拉油门显示屏</p>	
<p>YEM-H3847</p>  <p>液晶片 LCD SK200-6E</p>	<p>YEM-H3848</p>  <p>液晶片 LCD SK200-6</p>	<p>YEM-H3849</p>  <p>液晶片 LCD DH820</p>	<p>YEM-H3850</p>  <p>液晶片 LCD CAT320</p>	
<p>YEM-H3851</p>  <p>液晶片 LCD CAT320B</p>	<p>YEM-H3852</p>  <p>液晶片 LCD CAT320D</p>	<p>YEM-H3853</p>  <p>液晶片 LCD SH200A1</p>	<p>YEM-H3854</p>  <p>功率模块电子控制器 IC SS2B003 Function Module E-controller</p>	
<p>YEM-H3855</p>  <p>功率模块电子控制器 IC M5M27C512AK Function Module E-controller</p>	<p>YEM-H3856</p>  <p>功率模块电子控制器 IC DR-03 Function Module E-controller</p>	<p>YEM-H3857</p>  <p>A:PC-6显示屏按键灯板 B:SK200-3按键灯板</p>	<p>YEM-H3858</p>  <p>显示屏贴纸 Surface PC200-7</p>	
		<p>YEM-H3859</p>  <p>显示屏贴纸 Surface PC200-5/6D95</p>		
<p>YEM-H3860</p>  <p>显示屏贴纸 Surface HD 820</p>	<p>YEM-H3861</p>  <p>显示屏贴纸 Surface PC200-6/6D102</p>	<p>YEM-H3862</p>  <p>显示屏贴纸 Surface PC200-6/6D95</p>	<p>YEM-H3863</p>  <p>显示屏贴纸 Surface CAT 320</p>	
		<p>YEM-H3864</p>  <p>显示屏贴纸 Surface CAT 320C(上盖/下盖)</p>		

油门电机 THROTTLE MOTOR

油门电机 THROTTLE MOTOR

YEM-H3865



小松200-5油门电机(正厂定位器)
PC120/200/220-5
7824-30-1600

YEM-H3866



小松200-6油门电机(正厂定位器)
PC120/200/220-6
PC350/400/450-6
7834-40-2000/2001/2003

YEM-H3867



小松200-7油门电机(正厂定位器)
PC200/220-7
PC300/360-7
7834-41-2000/2001/2002

YEM-H3868



小松60-7油门电机
PC60-7/PC228UU
PC128UU(通用洋马)
22U-06-11790/11113
201-43-72122

YEM-H3869



卡特307油门电机(圆插)
E307

YEM-H3870



卡特307B油门电机(方插)
E307B/E308C/E305C
102-8007
132-7786

YEM-H3871



卡特312油门电机(双线)
E312V2
247-5227

YEM-H3872



卡特320油门电机(单线)
E320V1
E325/330-L
106-0092/0100
106-0097

YEM-H3873



卡特320油门电机(双线)
E320
7Y-3913
4I-5496

YEM-H3874



卡特320B油门电机(6线)
E320B/312B
119-0633
247-5231

YEM-H3875



卡特320C油门电机(7线)
E320C/312C
E320D(直嘴)
247-5212 227-7672
157-3177 171-2590

YEM-H3876



E320D油门电机

YEM-H3877



卡特325B油门电机(5线)
E325B
151-9354

YEM-H3878



卡特330B油门电机
E330B
132-7778
247-5232
106-0126
305-5954

YEM-H3879



卡特330C油门电机(7线/单线)
E330C/E307C/E307D/E322
106-0126
305-5954

YEM-H3880



日立200-2/3油门电机
EX200-2/3 EX300-2/3
ZAXIS330
4257163
4188762

YEM-H3881



日立200-5油门电机
EX200-5/6 EX300-5
ZAX210/240/330
4614911
4360509

YEM-H3882



神钢200-3/5油门电机
SK200-1/3/5
2406U197F4

YEM-H3883



神钢200-6油门电机
SK200-6
SK75-8
YN20S00002F3

YEM-H3884



神钢200-6E油门电机
SK200-6E SK230-6E
YN20S00002F1

YEM-H3885



大宇油门电机(方形)
DH225-7 DH300-5/7
DH258-5 DH360/420
DH150-7 DH370/500
523-00006

YEM-H3886



大宇油门电机(圆形)
DH220-5
DH280
2523-9014

YEM-H3887



大宇60油门电机(12V)
DH60 12V

YEM-H3888



现代油门电机(方形)
R110-7 R150LC-7
R215-7/9 R225-7
R150LC-9 R150W-9
21EN-32260

油门电机 THROTTLE MOTOR

油门电机 THROTTLE MOTOR

YEM-H3892



现代新款油门电机(长线)
R275LC-9T R335LC-7
R305LC-9T R335LC-9T 21EN-32360

YEM-H3893



加藤油门电机(短线)
HD450-7 HD700-5/7
HD512 HD820-1/II 709-4500006

YEM-H3894



加藤油门电机(长线)
HD800/900 HD1250
HD1023 HD1430 709-4510006

YEM-H3895



住友油门电机(9线)
SH100 SH120
SH200-A1/A2
KHR1713

YEM-H3896



住友油门电机(12线)
SH120-A1/A2
SH200-A1/A2
KHR1290 KHR1346

YEM-H3897



三一油门电机(老款)
SY135 SY210
SY215 SY230
LG6215 LG6225
SBW-YM-1

YEM-H3907



柳工915油门电机

YEM-H3908



力士德330油门电机

YEM-H3909



福田/中联 单插油门电机

YEM-H3898



三一油门电机(新款)
AC2/1000 AC2/1500 AC2/2000
SY205C-8 SY210C-8 SY215-8
SY365-8 SY75C-8 SY75C-9
B22050200001

YEM-H3899



福田雷沃油门电机
AC2/1500 AC2/2000
FR150
RJ04-61A12000A0

YEM-H3900



柳工油门电机
AC2/1500 AC2/2000
CLG915D CJG922D
CLG936D CLG225

YEM-H3913



山河智能油门电机

YEM-H3914



凯斯油门电机
CX75SR

YEM-H3915



山重油门电机

YEM-H3901



徐工油门电机
AC2/1000 AC2/1500
XE150B XE200
XE230 XE260

YEM-H3902



龙工油门电机
AC2/1500 AC2/2000
LG6210 LG6215 LG6225 LG6235
2002-1104-560

YEM-H3903



厦工油门电机AC2/1000
XG808/XG815/XG821
XG822/XG825/XG833
SERIAL NO.004036

YEM-H3916



久保田油门电机

YEM-H3917



山重油门电机

YEM-H3918



玉柴85-135油门电机

YEM-H3904



山河智能油门电机
AC2/1000 AC2/1500
SWE150/SWE210/SWE230
SWE330/SWE360

YEM-H3905



力士德油门电机

YEM-H3906



中联75

YEM-H3919



沃尔沃油门电机

YEM-H3920



国机重工油门电机
国机重工
福田雷沃
合肥振宇

YEM-H3921



油门小电机
E320B/C
ACCELERATOR

YEM-H3922



油门小电机
E320
KATO/HYUNDAI
ACCELERATOR

YEM-H3923



油门电机模块
E320B 6 LINES
MOTOR DRIVE MODULE

YEM-H3924



油门电机模块
E320C 7 LINES
MOTOR DRIVE MODULE

YEM-H3925



油门电机模块
E320
MOTOR DRIVE MODULE

YEM-H3926



油门电机模块
E325B/E330B 5 LINES
MOTOR DRIVE MODULE

YEM-H3927



油门电机模块
国产机型
MOTOR DRIVE MODULE

YEM-H3928



油门电机模块
国产机型
MOTOR DRIVE MODULE

YEM-H3929



油门马达齿
PC200-5/6
GEAR

油门马达齿
E320/HD
GEAR

YEM-H3930



油门马达橡胶齿
EX120 EX200-5/6
RUBBER GEAR

YEM-H3931



拉线座
E320C/DH/R
GEAR

YEM-H3932



拉线轮
GEAR

YEM-H3933



卡特CAT
CLUTCH

YEM-H3934



油门手柄 CLUTCH
PC60/PC120
PC200-3/5/6
203-42-61370

YEM-H3935



油门手柄 CLUTCH
CAT ERPILLAR
KATO

YEM-H3936



SK-3
油门马达摇臂和拉杆
SWING URM

YEM-H3937



日立油门推销

YEM-H3938



SK油门推销

YEM-H3939



SK油门推销

YEM-H3940



油门推杆
SPRING ASSY
PC120-5/PC100-5

YEM-H3941



油门推杆
SPRING ASSY
PC100-5/6 6D95
PC60 4D95

YEM-H3942



油门推杆
SPRING ASSY
PC60

YEM-H3943



油门推杆
SPRING ASSY
PC300 6D125
PC200-6 6D102

YEM-H3944



SK 油门推杆
SPRING ASSY

YEM-H3945



油门推杆
SPRING ASSY
E

YEM-H3946



油门推钩 LEVER
PC120
20Y-43-12143

YEM-H3947



油门推钩 LEVER
PC200-5
20Y-43-12141

YEM-H3948



SH住友液压先导锁

YEM-H3949



R-9

YEM-H3950



R-7老款

YEM-H3951



R-7老款

YEM-H3952



E320B

YEM-H3953



E320D

YEM-H3954



VOLVO210B

YEM-H3955



PC-7

YEM-H3956



DX260

油门旋钮 DIAL FUEL

<p>YEM-H3957</p>  <p>卡特320B/C 油门旋钮 E320B/E320C/320D 163-6710 DIAL FUEL</p>	<p>YEM-H3958</p>  <p>卡特320 油门旋钮 E320/E312 DIAL FUEL</p>	<p>YEM-H3959</p>  <p>卡特329D 油门旋钮 E329D DIAL FUEL</p>	<p>YEM-H3960</p>  <p>三一油门旋钮 SANY DIAL FUEL</p>
<p>YEM-H3961</p>  <p>徐工 XG60/80/85/135 150/215/235(十档)</p>	<p>YEM-H3962</p>  <p>徐工 608085/135/150/215 10921015</p>	<p>YEM-H3963</p>  <p>柳工 925D/936/908/922D</p>	<p>YEM-H3964</p>  <p>柳工 908D 37B1019</p>
<p>YEM-H3965</p>  <p>柳工 920E/922E/925E 936E/948E 34B0760</p>	<p>YEM-H3966</p>  <p>柳工 906C/908C/D/915D/920D 37B115B</p>	<p>YEM-H3967</p>  <p>小松 PC200-7/PC210/220-7</p>	<p>YEM-H3968</p>  <p>小松 PC200-7/PC210/220-7 22U-06-22420 DIAL FUEL</p>
<p>YEM-H3969</p>  <p>小松200-6 油门旋钮 PC200-3/5/6 7825-30-1301 DIAL FUEL</p>	<p>YEM-H3970</p>  <p>PC-8旋钮开关 DIAL FUEL</p>	<p>YEM-H3971</p>  <p>神钢200-3油门旋钮 SK200-3/5 DIAL FUEL</p>	<p>YEM-H3972</p>  <p>神钢 Sk75 75-8</p>
<p>YEM-H3973</p>  <p>神钢200-6油门旋钮 SK200-6 YN52S00009P1/P2/P3 DIAL FUEL</p>	<p>YEM-H3974</p>  <p>ZAX油门旋钮 ZAX200-3 4631128 DIAL FUEL</p>	<p>YEM-H3975</p>  <p>日立 ZAX200/240/250 330-3/360-3 总成</p>	<p>YEM-H3976</p>  <p>日立 ZAX60/70/200 240/330-6-3G 总成</p>
<p>YEM-H3977</p>  <p>日立 ZAX60/70/200 240/330-6-3G</p>	<p>YEM-H3978</p>  <p>日立 ZAX200/240/250 330-3/360-3</p>	<p>YEM-H3979</p>  <p>日立油门旋钮 EX200-5/EX120-5 4341545</p>	<p>YEM-H3980</p>  <p>加藤 HD510/700/820 707-77519001</p>

油门旋钮 DIAL FUEL

<p>YEM-H3981</p>  <p>现代 R80-7 21N1-10082 13D18-004</p>	<p>YEM-H3982</p>  <p>现代 215-9/225-9/385-9 305-9/485-9/465-9</p>	<p>YEM-H3983</p>  <p>现代R225-7/215-7/305-7(新款) 265-7/455-7 21NB-20506/17A04006</p>	<p>YEM-H3984</p>  <p>现代R215-7 225-7(老款) 21NB-20501 15A22-011</p>
<p>YEM-H3985</p>  <p>现代油门旋钮 R220-5/R225-7 21NB-20902</p>	<p>YEM-H3986</p>  <p>大宇 130/150/220/225 258/300-5-7-9 300661-00004</p>	<p>YEM-H3987</p>  <p>住友油门旋钮 SH200A3/A5 DIAL FUEL COVER</p>	<p>YEM-H3988</p>  <p>住友A1/A2</p>
<p>YEM-H3989</p>  <p>力士德 SC150/210 220/260/360</p>	<p>YEM-H3990</p>  <p>沃尔沃210油门旋钮 VOLVO210/240/290 VOE14542152 DIAL FUEL</p>	<p>YEM-H3991</p>  <p>沃尔沃460油门旋钮 VOLVO460/480 DIAL FUEL</p>	<p>YEM-H3992</p>  <p>沃尔沃 EC250D EC350D EC380D EC480D</p>
<p>YEM-H3993</p>  <p>彭浦230旋钮开关 DIAL FUEL</p>	<p>YEM-H3994</p>  <p>临工油门旋钮 SDLG DIAL FUEL</p>	<p>YEM-H3995</p>  <p>厦工 XG815 XG822 XG823 XG825 XG836(方插)</p>	<p>YEM-H3996</p>  <p>厦工 XG815 XG822 XG823 XG825 XG836(扁插)</p>
<p>YEM-H3997</p>  <p>厦工 XG806 XG820 XG821 XG822 XG823 833</p>	<p>YEM-H3998</p>  <p>龙工LG6150 LG6360 01874</p>	<p>YEM-H3999</p>  <p>玉柴 YC55/60/65/85/135/230</p>	<p>YEM-H4000</p>  <p>福田 雷沃 150/170/230</p>

油门马达定位器 FITTING SENSOR

电磁阀 SOLENOID

YEM-H4001



PC200-5油门马达定位器
7861-92-4130
FITTING SENSOR

YEM-H4002



PC200-6油门马达定位器
7861-93-4130
FITTING SENSOR

YEM-H4003



PC200-7油门马达定位器
7861-93-4131
FITTING SENSOR

YEM-H4004



PC200-5/6定位器 (进口)
7861-92-4130
FITTING SENSOR

YEM-H4005



PC200-7定位器 (进口)
7861-93-4131
FITTING SENSOR

YEM-H4006



EX200-2/3油门马达定位器
EX200-2/3
4257164
FITTING SENSOR

YEM-H4007



EX200-5/6 ZAX油门马达定位器
EX200-5/6 ZAX210/240/330
4614912
FITTING SENSOR

YEM-H4008



卡特320油门马达定位器
E320
FITTING SENSOR

YEM-H4009



卡特320B/C油门马达定位器
E320B/C DH220-5(方形)
247-5230 227-7658
FITTING SENSOR

YEM-H4010



神钢200-3油门马达定位器
SK200-3/5
FITTING SENSOR

YEM-H4011



神钢200-6油门马达定位器
SK200-6
FITTING SENSOR

YEM-H4012



神钢200-6E油门马达定位器
SK200-6E
FITTING SENSOR

YEM-H4013



大宇油门马达定位器 (圆形)
DH220-5(圆形)
FITTING SENSOR

YEM-H4014



现代油门马达定位器
R220-5/7
FITTING SENSOR

YEM-H4015



小松128UU定位器
PC128UU
FITTING SENSOR

YEM-H4016



三一定位器

YEM-H4017



定位器齿轮
PC200-5/6
PC20-7
GEAR

YEM-H4018



神钢电磁阀组

YEM-H4019



三一电磁阀组

YEM-H4020



小松电磁阀组

YEM-H4021



PC55电磁阀组

YEM-H4022



PC200-8电磁阀组

YEM-H4023



PC400-8电磁阀组

YEM-H4024



PC300-7电磁阀组

YEM-H4025



PC200-7电磁阀组

YEM-H4026



PC130-7电磁阀组

YEM-H4027



VOLVO电磁阀组

YEM-H4028



HITACHI
4414761
9218271

YEM-H4029



310004
9258047

YEM-H4030



011017
9258048

YEM-H4031



309620
9254306

YEM-H4032



BOSCH
02113830
0241754022004500

YEM-H4033



J05 EGR阀总成

YEM-H4034



SH200电磁阀

YEM-H4035



J08 EGR阀总成

YEM-H4036



4HK1

YEM-H4037



6HK1

电磁阀 SOLENOID

电磁阀 SOLENOID

<p>YEM-H4038</p>  <p>260-4444</p>	<p>YEM-H4039</p>  <p>电磁阀组</p>	<p>YEM-H4040</p>  <p>电磁阀组</p>	<p>YEM-H4041</p>  <p>电磁阀组</p>
<p>YEM-H4042</p>  <p>溢流阀</p>	<p>YEM-H4043</p>  <p>VOLVO电磁阀 14616530</p>	<p>YEM-H4044</p>  <p>VOLVO电磁阀 14616529</p>	<p>YEM-H4045</p>  <p>SK-8 EGR 电磁阀</p>
<p>YEM-H4046</p>  <p>SCV短阀</p>	<p>YEM-H4047</p>  <p>SCV阀 (长款) 8-98043687-0</p>	<p>YEM-H4048</p>  <p>PC450</p>	<p>YEM-H4049</p>  <p>PC450</p>
<p>YEM-H4050</p>  <p>PC200-8燃油计量单元</p>	<p>YEM-H4051</p>  <p>SK130/140-8</p>	<p>YEM-H4052</p>  <p>卡特电磁阀</p>	<p>YEM-H4053</p>  <p>JCB</p>
<p>YEM-H4054</p>  <p>12VDC 600092</p>	<p>YEM-H4055</p>  <p>卡特装载机电磁阀 CAT 121-4036</p>	<p>YEM-H4056</p>  <p>PC300-7</p>	<p>YEM-H4057</p> 

<p>YEM-H4058</p>  <p>力士乐电磁阀 R901155051</p>  <p>力士乐电磁阀 R900727801</p>	<p>YEM-H4059</p>  <p>ZAX200电磁阀 ZAX200 9218234 SOLENOID VALVE</p>	<p>YEM-H4060</p>  <p>ZAX200-3 反比例电磁阀</p>	<p>YEM-H4061</p>  <p>EX200-5电磁阀 方插 EX200-5 9218229 SOLENOID VALVE</p>	<p>YEM-H4062</p>  <p>ZAX电喷 反比例电磁阀</p>
<p>YEM-H4063</p>  <p>ZAX200-3 正比例电磁阀</p>	<p>YEM-H4064</p>  <p>SK60带孔</p>	<p>YEM-H4065</p>  <p>SK60 无孔</p>	<p>YEM-H4066</p>  <p>SK60 绿插</p>	<p>YEM-H4067</p>  <p>SH200A5电磁阀</p>
<p>YEM-H4068</p>  <p>雷沃电磁阀 Solenoid Valve</p>	<p>YEM-H4069</p>  <p>E307电磁阀</p>	<p>YEM-H4070</p>  <p>日立转移传感器</p>	<p>YEM-H4071</p>  <p>PC40/EX55电磁阀</p>	<p>YEM-H4072</p>  <p>SAA3电磁阀</p>
<p>YEM-H4073</p>  <p>E200B 主泵电磁阀</p>	<p>YEM-H4074</p>  <p>E320B 139-3990 主泵电磁阀 (带座)</p>	<p>YEM-H4075</p>  <p>K3V112电磁阀 白插</p>	<p>YEM-H4076</p>  <p>E345D电磁阀</p>	<p>YEM-H4077</p>  <p>SH200A1 电磁阀</p>
<p>YEM-H4078</p>  <p>液压泵电磁阀 Solenoid Valve K3V112</p>	<p>YEM-H4079</p>  <p>液压泵电磁阀 Solenoid Valve E200B</p>	<p>YEM-H4080</p>  <p>液压泵电磁阀 Solenoid Valve E320C</p>	<p>YEM-H4081</p>  <p>日立高速电磁阀</p>	<p>YEM-H4082</p>  <p>压差传感器 D.P.SENSOR EX200-3/5 4339559/91</p>

电磁阀 SOLENOID

<p>YEM-H4083</p>  <p>DP传感器 4339559</p>	<p>YEM-H4084</p>  <p>PC200-6主泵电磁阀 702-21-07010 Main pump solenoid</p>	<p>YEM-H4085</p>  <p>PC200-7 702-21-57400/57500 主泵电磁阀 Main pump solenoid</p>	<p>YEM-H4086</p>  <p>PC60-5电磁阀 Solenoid valve</p>
<p>YEM-H4087</p>  <p>小松电磁阀 PC Solenoid 561-15-47210</p>	<p>YEM-H4088</p>  <p>PC120-5/6 203-60-56180 旋转电磁阀 Solenoid valve</p>	<p>YEM-H4089</p>  <p>PC200-6/6D95 旋转电磁阀 20Y-60-22121 Solenoid valve</p>	<p>YEM-H4090</p>  <p>PC200-5/6D95 旋转电磁阀 20Y-60-11713 Solenoid valve</p>
<p>YEM-H4091</p>  <p>PC200-3/5 708-2H-25240/708-23-18272 主泵电磁阀 Solenoid Valve</p>	<p>YEM-H4092</p>  <p>PC200-6/6D102 旋转电磁阀 206-60-51130 206-60-51131</p>	<p>YEM-H4093</p>  <p>PC200-7 旋转电磁阀 20Y-60-32120 Solenoid valve</p>	<p>YEM-H4094</p>  <p>PC400-8主泵电磁阀</p>
<p>YEM-H4095</p>  <p>EX回转电磁阀</p>	<p>YEM-H4096</p>  <p>液压泵电磁阀 Solenoid Valve SK200-6 K3V112 MC609-7421120</p>	<p>YEM-H4097</p>  <p>VOLVO长线</p>	<p>YEM-H4098</p>  <p>沃尔沃电磁阀 VOLVO210N5-7LPM W3BI007ANGSB4Y SOLENOID VALVE</p>
<p>YEM-H4099</p>  <p>HD820安全锁定电磁阀 HD820 KDRDE5K-20/G24D05 SOLENOID VALVE</p>	<p>YEM-H4100</p>  <p>SK200-2行走直径电磁阀 SK120/200-2 YN35V00004F2 KDRDE5K-20/30C12-101 SOLENOID VALVE</p>	<p>YEM-H4101</p>  <p>朱仔泵电子阀/带线 SK200-2 YN35V00004F1 KDRDE5K-20/30C12A-111 SKX5P-17-212A SOLENOID VALVE</p>	<p>YEM-H4102</p>  <p>安全锁定电磁阀 SK200-2 YN35V00005F1 KWE5K-20/G24D12A</p>

电磁阀 SOLENOID

<p>YEM-H4103</p>  <p>SK200-2旋转刹车电磁阀 SK120/200-2 YN35V00005F2 KWE5K-20/G24Y12A SOLENOID VALVE</p>	<p>YEM-H4104</p>  <p>K3V112 正比例电磁阀</p>	<p>YEM-H4105</p>  <p>K3V112 反比例电磁阀</p>	<p>YEM-H4106</p>  <p>SK200-8 YN35V00050F1 KWE5K-31 G24DB50 安全锁定电磁阀</p>
<p>YEM-H4107</p>  <p>SK200-6E YN35V00041F1 KDRDE5K-31 30C50-102 珠子泵电磁阀电磁阀</p>	<p>YEM-H4108</p>  <p>SK200-3 YN35V00019F1 KDRDE5K-31 30C40-101 行走(直行)电磁阀</p>	<p>YEM-H4109</p>  <p>SK200-8 YN35V00052F1 KWE5K-31 30C50-123 珠子泵电磁阀</p>	<p>YEM-H4110</p>  <p>SK200-8 YN35V00048F1 KDRDE5K-31 30C50-122 行走直行电磁阀</p>
<p>YEM-H4111</p>  <p>SK200-8 YN35V00051F1 KWE5K-31 G24YB50 回转电磁阀</p>	<p>YEM-H4112</p>  <p>SK200-8 YN35V00049F1 KWE5K-31 30C50-213 小臂电磁阀</p>	<p>YEM-H4113</p>  <p>SK200-6 YN35V00021F1 KWE5K-31 G24YA40 回转刹车电磁阀</p>	<p>YEM-H4114</p>  <p>SK200-6 YN35V00018F2 KDRDE5K-31 30C40-111</p>
<p>YEM-H4115</p>  <p>SK230-6E YB35V00005F1 KDRDE5K-31 30C50-107 行走直行电磁阀</p>	<p>YEM-H4116</p>  <p>SK200-6电磁阀 SK200-6 KWE5K-31/G24DB40 SOLENOID VALVE</p>	<p>YEM-H4117</p>  <p>SK200-6 YN35V00020F1 KWE5K-31 GD24DA40</p>	<p>YEM-H4118</p>  <p>SK200-6E旋转刹车电磁阀 SK200-6E SK230-6E YN35V00006F1 KWE5K-31/G24YA50 SOLENOID VALVE</p>
<p>YEM-H4119</p>  <p>E320回转电磁阀 121-1490</p>	<p>YEM-H4120</p>  <p>E320B 121-1491 卡特回转电磁阀</p>	<p>YEM-H4121</p>  <p>E320C液压泵电磁阀 111-9916</p>	<p>YEM-H4122</p>  <p>E320B 121-1491 回转安全锁定电磁阀</p>

电磁阀线圈 SOLENOID VALVE COIL

<p>YEM-H4123</p>  <p>H: 38.5mm Φ: 13mm</p> <p>大宇55电磁阀线圈(小插) DH55 12V SOLENOID COIL</p>	<p>YEM-H4124</p>  <p>H: 59mm Φ: 20/21mm</p> <p>VOLVO电磁阀线圈 (24V) EC210B/240B/290B 24V 1452-7267 SOLENOID COIL</p>	<p>YEM-H4125</p>  <p>H: 59mm Φ: 20/21mm</p> <p>VOLVO电磁阀线圈(12V) EC55B 12V SOLENOID COIL</p>	<p>YEM-H4126</p>  <p>H: 59mm Φ: 20/21mm</p> <p>VOLVO电磁阀线圈(新款) VOLVO 电喷 SOLENOID COIL</p>
<p>YEM-H4127</p>  <p>H: 41.5mm Φ: 18mm</p> <p>玉柴电磁阀线圈(24V) YC 24V SOLENOID COIL</p>	<p>YEM-H4128</p>  <p>H: 41.5mm Φ: 18mm</p> <p>玉柴电磁阀线圈(12V) YC 12V SOLENOID COIL</p>	<p>YEM-H4129</p>  <p>H: 42mm Φ: 16mm</p> <p>沃德电磁阀线圈(24V) 沃德 24V SOLENOID COIL</p>	<p>YEM-H4130</p>  <p>H: 42mm Φ: 16mm</p> <p>沃德电磁阀线圈(12V) 沃德 12V SOLENOID COIL</p>
<p>YEM-H4131</p>  <p>H: 42mm Φ: 16mm</p> <p>三一电磁阀线圈(24V) SANY 24V SOLENOID COIL</p>	<p>YEM-H4132</p>  <p>H: 42mm Φ: 16mm</p> <p>三一电磁阀线圈(12V) SANY 12V SOLENOID COIL</p>	<p>YEM-H4133</p>  <p>H: 51mm Φ: 23mm</p> <p>三一电磁阀线圈(带继电器) SANY 24V SOLENOID COIL</p>	<p>YEM-H4134</p>  <p>H: 51mm Φ: 23mm</p> <p>三一电磁阀线圈 SANY 24V SOLENOID COIL</p>
<p>YEM-H4135</p>  <p>H: 46mm Φ: 13mm</p> <p>三一电磁阀线圈(圆) SANY 12V SOLENOID COIL</p>	<p>YEM-H4136</p>  <p>H: 39mm Φ: 12mm</p> <p>日立电磁阀线圈(24V) EX 0640202 24V SOLENOID COIL</p>	<p>YEM-H4137</p>  <p>H: 39mm Φ: 12mm</p> <p>日立电磁阀线圈(12V) EX 0640202 12V SOLENOID COIL</p>	<p>YEM-H4138</p>  <p>H: 37.5mm Φ: 13mm</p> <p>山河智能电磁阀线圈(24V) 24V SOLENOID COIL</p>
<p>YEM-H4139</p>  <p>H: 37.5mm Φ: 13mm</p> <p>山河智能电磁阀线圈(12V) 12V SOLENOID COIL</p>	<p>YEM-H4140</p>  <p>H: 55mm Φ: 20mm</p> <p>SKM6电磁阀线圈 SKM6 24V SOLENOID COIL</p>	<p>YEM-H4141</p>  <p>三一/中联泵车 电磁阀线圈 SOLENOID COIL</p>	<p>YEM-H4142</p>  <p>三一泵车 电磁阀线圈 SOLENOID COIL</p>

电磁阀线圈 SOLENOID VALVE COIL

<p>YEM-H4143</p>  <p>三一/中联泵车 电磁阀线圈 SOLENOID COIL</p>	<p>YEM-H4144</p>  <p>H: 42mm Φ: 16mm</p> <p>电磁阀线圈(两插) 国产机型 SOLENOID COIL</p>	<p>YEM-H4145</p>  <p>H: 40.5mm Φ: 18mm</p> <p>龙工电磁阀线圈(24V) 龙工/贺德克 24V SOLENOID COIL</p>	<p>YEM-H4146</p>  <p>H: 40.5mm Φ: 18mm</p> <p>龙工电磁阀线圈(12V) 龙工/贺德克 12V SOLENOID COIL</p>
<p>YEM-H4147</p>  <p>H: 37mm Φ: 13mm</p> <p>厦工电磁阀线圈(24V) 厦工822 24V SOLENOID COIL</p>	<p>YEM-H4148</p>  <p>H: 37mm Φ: 13mm</p> <p>厦工电磁阀线圈(12V) 厦工 12V SOLENOID COIL</p>	<p>YEM-H4149</p>  <p>H: 36.5mm Φ: 13mm</p> <p>厦工电磁阀线圈(28V) 厦工 24V SOLENOID COIL</p>	<p>YEM-H4150</p>  <p>H: 36.5mm Φ: 13mm</p> <p>厦工电磁阀线圈(14V) 厦工 12V SOLENOID COIL</p>
<p>YEM-H4151</p>  <p>H: 39mm Φ: 13mm</p> <p>福田电磁阀线圈 12V/24V SOLENOID COIL</p>	<p>YEM-H4152</p>  <p>H: 40mm Φ: 18mm</p> <p>福田电磁阀线圈 24V SOLENOID COIL</p>	<p>YEM-H4153</p>  <p>H: 48.5mm Φ: 22mm</p> <p>川崎电磁阀线圈 12V/24V SOLENOID COIL</p>	<p>YEM-H4154</p>  <p>H: 49.5mm Φ: 19mm</p> <p>徐工电磁阀线圈 徐工 24V SOLENOID COIL</p>
<p>YEM-H4155</p>  <p>H: 39.5mm Φ: 16mm</p> <p>电磁阀线圈 12V/24V SOLENOID COIL</p>	<p>YEM-H4156</p>  <p>H: 51mm Φ: 23mm</p> <p>电磁阀线圈 12V/24V SOLENOID COIL</p>	<p>YEM-H4157</p>  <p>H: 54mm Φ: 23mm</p> <p>电磁阀线圈 12V/24V SOLENOID COIL</p>	<p>YEM-H4158</p>  <p>H: 58mm Φ: 19mm</p> <p>电磁阀线圈 12V/24V SOLENOID COIL</p>
<p>YEM-H4159</p>  <p>H: 49mm Φ: 13/18mm</p> <p>电磁阀线圈 12V/24V SOLENOID COIL</p>	<p>YEM-H4160</p>  <p>H: 50mm Φ: 19mm</p> <p>电磁阀线圈 12V/24V SOLENOID COIL</p>	<p>YEM-H4161</p>  <p>H: 52mm Φ: 20mm</p> <p>电磁阀线圈 12V/24V SOLENOID COIL</p>	<p>YEM-H4162</p>  <p>H: 39mm Φ: 13mm</p> <p>力士乐电磁阀线圈(26V) 力士乐 26V SOLENOID COIL</p>

电磁阀线圈 SOLENOID VALVE COIL

<p>YEM-H4163</p>  <p>H: 39mm Φ: 13mm</p> <p>力士乐电磁阀线圈(14V) 力士乐 14V SOLENOID COIL</p>	<p>YEM-H4164</p>  <p>H: 37.5mm Φ: 13mm</p> <p>卡特325电磁阀线圈 E325 SOLENOID COIL</p>	<p>YEM-H4165</p>  <p>H: 51mm Φ: 14mm</p> <p>住友A5电磁阀线圈 SH200A5 SOLENOID COIL</p>	<p>YEM-H4166</p>  <p>H: 52.5mm Φ: 14mm</p> <p>住友A3电磁阀线圈 SH200A3 SOLENOID COIL</p>
<p>YEM-H4167</p>  <p>H: 40mm Φ: 13mm</p> <p>小松旋转电磁阀线圈 PC200-5 PC200-6/6D95</p>	<p>YEM-H4168</p>  <p>H: 47mm Φ: 14mm</p> <p>小松旋转电磁阀线圈 PC200/220-7 PC200-8 SOLENOID COIL</p>	<p>YEM-H4169</p>  <p>H: 47mm Φ: 14mm</p> <p>小松旋转电磁阀线圈 PC200-6/6D102 SOLENOID COIL</p>	<p>YEM-H4170</p>  <p>H: 48mm Φ: 16mm</p> <p>小松120电磁阀线圈 PC120-6/PC60-7 PC60-6(新款) SOLENOID COIL</p>
<p>YEM-H4171</p>  <p>H: 31mm Φ: 16mm</p> <p>小松60电磁阀线圈 PC60-5/PC120-5 PC60-6(老款) SOLENOID COIL</p>	<p>YEM-H4172</p>  <p>H: 38.5mm Φ: 12mm</p> <p>小松40电磁阀线圈(12V) PC35/PC40 12V SOLENOID COIL</p>	<p>YEM-H4173</p>  <p>H: 38.5mm Φ: 12mm</p> <p>小松40电磁阀线圈(24V) PC35/PC40 24V SOLENOID COIL</p>	<p>YEM-H4174</p>  <p>H: 40mm Φ: 18mm</p> <p>现代电磁阀线圈 R225-7 24V SOLENOID COIL</p>
<p>YEM-H4175</p>  <p>H: 39mm Φ: 13mm</p> <p>现代电磁阀线圈 R210-9(新款) XKAL-00050 SOLENOID COIL</p>	<p>YEM-H4176</p>  <p>H: 52mm Φ: 13mm</p> <p>现代电磁阀线圈 R215-7 24V XKBL-00004 SOLENOID COIL</p>	<p>YEM-H4177</p>  <p>H: 52mm Φ: 13mm</p> <p>现代电磁阀线圈 R60-5/7 12V SOLENOID COIL</p>	<p>YEM-H4178</p>  <p>H: 50mm Φ: 16mm</p> <p>现代电磁阀线圈 R210/220-5(圆) 24V SOLENOID COIL</p>
<p>YEM-H4179</p>  <p>H: 39mm Φ: 13mm</p> <p>现代电磁阀线圈 R210/220-5(方) 24V SOLENOID COIL</p>	<p>YEM-H4180</p>  <p>H: 39mm Φ: 13mm</p> <p>现代电磁阀线圈 R55 12V SOLENOID COIL</p>	<p>YEM-H4181</p>  <p>H: 52mm Φ: 16mm</p> <p>大字电磁阀线圈 (24V) DH 24V SOLENOID COIL</p>	<p>YEM-H4182</p>  <p>H: 52mm Φ: 16mm</p> <p>大字电磁阀线圈 (12V) DH 12V SOLENOID COIL</p>

电磁阀线圈 SOLENOID VALVE COIL

<p>YEM-H4183</p>  <p>H: 63mm Φ: 20mm</p> <p>大字300电磁阀线圈 DH300 24V SOLENOID COIL</p>	<p>YEM-H4184</p>  <p>H: 52.5mm Φ: 14mm</p> <p>大字60电磁阀线圈(大插) DH60 12V SOLENOID COIL</p>	<p>YEM-H4185</p>  <p>H: 52.5mm Φ: 14mm</p> <p>大字60电磁阀线圈(小插) DH60 12V SOLENOID COIL</p>	<p>YEM-H4186</p>  <p>H: 38.5mm Φ: 13mm</p> <p>大字55电磁阀线圈(大插) DH55 12V SOLENOID COIL</p>
<p>YEM-H4187</p>  <p>H: 47mm Φ: 14mm</p> <p>日立旋转电磁阀线圈 EX SOLENOID COIL</p>	<p>YEM-H4188</p>  <p>JCB电磁阀线圈 SOLENOID COIL</p>	<p>YEM-H4189</p>  <p>福田雷沃电磁阀线圈 SOLENOID COIL</p>	<p>YEM-H4190</p>  <p>E307电磁阀线圈 SOLENOID COIL</p>
<p>YEM-H4191</p>  <p>JCB(三线)电磁阀线圈 SOLENOID COIL</p>	<p>YEM-H4192</p>  <p>徐工电磁阀线圈 SOLENOID COIL</p>	<p>YEM-H4193</p>  <p>H: 73mm Φ: 17mm</p> <p>卡特比例电磁阀线圈 E320B/C SOLENOID COIL</p>	<p>YEM-H4194</p>  <p>H: 73mm Φ: 17mm</p> <p>卡特旋转电磁阀线圈 E320B/C SOLENOID COIL</p>
<p>YEM-H4195</p>  <p>H: 73mm Φ: 17mm</p> <p>卡特安全锁定电磁阀线圈 E320B/C SOLENOID COIL</p>	<p>YEM-H4196</p>  <p>H: 73mm Φ: 17mm</p> <p>SK200-5/6比例电磁阀线圈 SK200-5/6 SOLENOID COIL</p>	<p>YEM-H4197</p>  <p>H: 73mm Φ: 17mm</p> <p>SK200-5/6行走电磁阀线圈 SK200-5/6 SOLENOID COIL</p>	<p>YEM-H4198</p>  <p>H: 73mm Φ: 17mm</p> <p>SK200-5/6旋转刹车电磁阀线圈 SK200-5/6 SOLENOID COIL</p>
<p>YEM-H4199</p>  <p>H: 73mm Φ: 17mm</p> <p>SK200-5/6安全锁定电磁阀线圈 SK200-5/6 SOLENOID COIL</p>	<p>YEM-H4200</p>  <p>H: 73mm Φ: 17mm</p> <p>SK200-6E/8比例电磁阀线圈 SK200-6E/8 SOLENOID COIL</p>	<p>YEM-H4201</p>  <p>E320D 柴油泵电磁阀(大头)</p>	<p>YEM-H4202</p>  <p>卡特D型机 C7高压油泵电磁阀(小头)</p>

电磁阀阀芯 SOLENOID VALVE CORE

<p>YEM-H4203</p>  <p>大宇电磁阀阀芯</p>	<p>YEM-H4204</p>  <p>DH-5电磁阀阀芯</p>	<p>YEM-H4205</p>  <p>DH-7电磁阀阀芯</p>	<p>YEM-H4206</p>  <p>DH-9电磁阀阀芯</p>
<p>YEM-H4207</p>  <p>DH05阀芯</p>	<p>YEM-H4208</p>  <p>DH-7阀芯</p>	<p>YEM-H4209</p>  <p>三一-75阀芯</p>	<p>YEM-H4210</p>  <p>三一/沃德电磁阀阀芯</p>
<p>YEM-H4211</p>  <p>三一新款阀芯</p>	<p>YEM-H4212</p>  <p>三一阀芯凸</p>	<p>YEM-H4213</p>  <p>三一阀芯凹</p>	<p>YEM-H4214</p>  <p>三一阀芯凸</p>
<p>YEM-H4215</p>  <p>新款三一阀芯凹</p>	<p>YEM-H4216</p>  <p>小松阀芯</p>	<p>YEM-H4217</p>  <p>小松阀芯</p>	<p>YEM-H4218</p>  <p>小松阀芯</p>
<p>YEM-H4219</p>  <p>现代电磁阀阀芯</p>	<p>YEM-H4220</p>  <p>日立阀芯</p>	<p>YEM-H4221</p>  <p>卡特307阀芯 1SV208-31 凹</p>	<p>YEM-H4222</p>  <p>卡特307阀芯凸</p>

电磁阀阀芯 SOLENOID VALVE CORE

<p>YEM-H4223</p>  <p>国产通用挖机</p>	<p>YEM-H4224</p>  <p>国产通用挖机 0D15021</p>	<p>YEM-H4225</p>  <p>国产通用挖机472881</p>	<p>YEM-H4226</p>  <p>国产通用挖机</p>
<p>YEM-H4227</p>  <p>柳工阀芯</p>	<p>YEM-H4228</p>  <p>现代阀芯</p>	<p>YEM-H4229</p>  <p>中联阀芯</p>	<p>YEM-H4230</p>  <p>中联小挖阀芯</p>
<p>YEM-H4231</p>  <p>徐工阀芯</p>	<p>YEM-H4232</p>  <p>厦工阀芯 DSV2-080</p>	<p>YEM-H4233</p>  <p>电磁阀阀芯 WK07L-01-C-V</p>	<p>YEM-H4234</p>  <p>电磁阀阀芯 EMDV-08-N-3K-0-00</p>
<p>YEM-H4235</p>  <p>电磁阀阀芯 EMDV-08-N-3M-0-00</p>	<p>YEM-H4236</p>  <p>电磁阀阀芯 SV08-30</p>	<p>YEM-H4237</p>  <p>电磁阀阀芯 DSV2-080-3-N</p>	<p>YEM-H4238</p>  <p>力士乐回转电磁阀</p>
<p>YEM-H4239</p>  <p>力士乐电磁阀阀芯 0D13105</p>	<p>YEM-H4240</p>  <p>溢流阀 PR10-32H-08-M30</p>	<p>YEM-H4241</p>  <p>电磁阀阀芯 04023-00000</p>	<p>YEM-H4242</p>  <p>电磁阀阀芯 WKM08130C-01-C-N</p>
<p>YEM-H4243</p>  <p>电磁阀SV98-T39</p>			

压力传感器 PRESSURE SWITCH

压力传感器 PRESSURE SWITCH

<p>YEM-H4244</p>  <p>燃油压力传感器 320-3064</p>	<p>YEM-H4245</p>  <p>燃油压力传感器 559907-02</p>	<p>YEM-H4246</p>  <p>燃油压力传感器 349-1178</p>	<p>YEM-H4247</p>  <p>C6.4/4.2共轨压力传感器 238-0118</p>
<p>YEM-H4248</p>  <p>燃油压力传感器 261-0420</p>	<p>YEM-H4249</p>  <p>燃油压力传感器 298-6488</p>	<p>YEM-H4250</p>  <p>3512B 进气温度传感器 194-6722</p>	<p>YEM-H4251</p>  <p>燃油压力传感器 320-3065</p>
<p>YEM-H4252</p>  <p>燃油压力传感器 451-2625</p>	<p>YEM-H4253</p>  <p>燃油传感器 375-6126</p>	<p>YEM-H4254</p>  <p>燃油压力传感器 296-5270</p>	<p>YEM-H4255</p>  <p>燃油压力传感器 284-2728</p>
<p>YEM-H4256</p>  <p>燃油压力传感器 344-7392</p>	<p>YEM-H4257</p>  <p>C9燃油共轨 压力传感器 224-4535</p>	<p>YEM-H4258</p>  <p>C9喷油自动 压力传感器 224-4536</p>	<p>YEM-H4259</p>  <p>C7.1燃油压力传感器 320-3062</p>
<p>YEM-H4260</p>  <p>3126B 机油压力传感器 194-6725</p>	<p>YEM-H4261</p>  <p>C9喷射压力传感器 248-2169-C02</p>	<p>YEM-H4262</p>  <p>燃油压力传感器 237-0957</p>	<p>YEM-H4263</p>  <p>燃油压力传感器 248-2169-C02</p>

<p>YEM-H4264</p>  <p>C15涡轮增压 压力传感器 274-6718</p>	<p>YEM-H4265</p>  <p>C7/C9 机油压力传感器 161-1705</p>	<p>YEM-H4266</p>  <p>C9 大气压力传感器 161-1703</p>	<p>YEM-H4267</p>  <p>C9 增压进气 压力传感器 161-1704</p>
<p>YEM-H4268</p>  <p>C9 增压进气 压力传感器 276-6793</p>	<p>YEM-H4269</p>  <p>C6.4 机油压力传感器 274-6721</p>	<p>YEM-H4270</p>  <p>C6.4 /4.2 发动机进气 压力传感器 274-6720</p>	<p>YEM-H4271</p>  <p>C9 喷油自动 压力传感器 274-6719</p>
<p>YEM-H4272</p>  <p>296-8060 010335B</p>	<p>YEM-H4273</p>  <p>C15 大气压力传感器 274-6717</p>	<p>YEM-H4274</p>  <p>HD压力开关 22F-06-33430</p>	<p>YEM-H4275</p>  <p>C7.1燃油压力传感器 320-3060</p>
<p>YEM-H4276</p>  <p>燃油自动压力传感器 344-7389</p>	<p>YEM-H4277</p>  <p>燃油传感器 344-7390</p>	<p>YEM-H4278</p>  <p>燃油压力传感器 344-7391</p>	<p>YEM-H4279</p>  <p>燃油压力传感器 419-5574</p>
<p>YEM-H4280</p>  <p>燃油压力传感器 237-0957</p>	<p>YEM-H4281</p>  <p>燃油压力传感器 344-7391-C01</p>	<p>YEM-H4282</p>  <p>SK-10低压 YN52S00102P1</p>	<p>YEM-H4283</p>  <p>燃油压力传感器 335-5321</p>

压力传感器 PRESSURE SWITCH

压力传感器 PRESSURE SWITCH

<p>YEM-H4284</p>  <p>燃油压力传感器 355-2701</p>	<p>YEM-H4285</p>  <p>EC350D/380/480 VOLVO低压传感器 17252661</p>	<p>YEM-H4286</p>  <p>VOLVO 17252660</p>	<p>YEM-H4287</p>  <p>VOLVO高压油泵传感器 17253748</p>	<p>YEM-H4288</p>  <p>卡特336D高压传感器 260-2180</p>
<p>YEM-H4289</p>  <p>E320B/C高压传感器 KM16-5YC</p>	<p>YEM-H4290</p>  <p>SK低压压力传感器 CP19-2</p>	<p>YEM-H4291</p>  <p>SK130-8/140-8 压力传感器</p>	<p>YEM-H4292</p>  <p>VOLVO360燃油传感器</p>	<p>YEM-H4293</p>  <p>VOLVO传感器 PN 923131 SN616B50197883</p>
<p>YEM-H4294</p>  <p>PC200-8高压传感器 7861-93-1812</p>	<p>YEM-H4295</p>  <p>PC200-7高压传感器 7861-93-1651</p>	<p>YEM-H4296</p>  <p>EX压力传感器(低压) 4436536</p>	<p>YEM-H4297</p>  <p>EX压力传感器(低压) 4436535</p>	<p>YEM-H4298</p>  <p>EX压力传感器(低压) 4332040</p>
<p>YEM-H4299</p>  <p>EX200-2/3/5 主泵压力传感器(高压) 4436271</p>	<p>YEM-H4300</p>  <p>大字压力开关(高压) 8211800-500K 9045-2547</p>	<p>YEM-H4301</p>  <p>Sh低压 KM15-P02 压力传感器</p>	<p>YEM-H4302</p>  <p>三一高压压力开关</p>  <p>三一低压压力开关</p>	<p>YEM-H4303</p>  <p>499000-4441 PC共轨传感器</p>
<p>YEM-H4304</p>  <p>SK200-6压力传感器(高压) LS52S00012P1</p>	<p>YEM-H4305</p>  <p>SK200-6E(高压) YN52S00027 P1</p>	<p>YEM-H4306</p>  <p>SK-低压 压力传感器(低压) LC52S00019P1</p>	<p>YEM-H4307</p>  <p>SK200压力传感器(付压) YN52S00016P3</p>	<p>YEM-H4308</p>  <p>SK200-8压力传感器(高压) LS52S00015P1</p>

<p>YEM-H4309</p>  <p>EX200-2/3 压力开关(优质) 20PS586-8V62 4254563</p>	<p>YEM-H4310</p>  <p>PC200-7 压力开关(优质) 20Y-06-21710</p>	<p>YEM-H4311</p>  <p>EX200-5 压力开关(优质) 20PS586-23 4380677</p>	<p>YEM-H4312</p>  <p>PC200-6 压力开关 20Y-06-21710</p>
<p>YEM-H4313</p>  <p>R225-7/9 高压 100Bar 液压泵传感器 31Q4-40820</p>	<p>YEM-H4314</p>  <p>R225-7/9 低压 50Bar 液压泵传感器 31Q4-40830</p>	<p>YEM-H4315</p>  <p>R225-7/9 高压 200Bar 液压泵传感器 31Q4-40810</p>	<p>YEM-H4316</p>  <p>R225-7/9 高压 500Bar 液压泵传感器 31Q4-40800</p>
<p>YEM-H4317</p>  <p>DH220-5 压力开关 20PS982-1 2549-9112</p>	<p>YEM-H4318</p>  <p>SH200A2/3/5 压力传感器(高压) KM16-P03</p>	<p>YEM-H4319</p>  <p>SK/EX, 4HK, 6HK1 共轨传感器(高压) 499000-6160</p>	<p>YEM-H4320</p>  <p>SK 低压压力传感器(优质) LC52S00019P1</p>
<p>YEM-H4321</p>  <p>Sk200 压力付压传感器(优质) YN52S00016P3</p>	<p>YEM-H4322</p>  <p>Sk200 压力付压传感器(优质) YN52800016P3</p>	<p>YEM-H4323</p>  <p>SK200-8 高压压力传感器(优质) LS52S00015P1</p>	<p>YEM-H4324</p>  <p>SK200-6 高压压力传感器(优质) YN52S00027P1</p>
<p>YEM-H4325</p>  <p>EX200-2/3 高压压力传感器(优质) 4436271</p>	<p>YEM-H4326</p>  <p>DH220-5/7 高压压力传感器(优质) 8111800-500L</p>	<p>YEM-H4327</p>  <p>SK200-6E 高压压力传感器(优质) LC52S00012P1</p>	<p>YEM-H4328</p>  <p>SH200A3/5 低压 压力传感器(优质) KM10-P02</p>

压力传感器 PRESSURE SWITCH

<p>YEM-H4329</p>  <p>SH200A2/3/5 高压压力传感器(优质) KM16-P03</p>	<p>YEM-H4330</p>  <p>HD820-3R 高压压力传感器(优质) KM10-P16</p>	<p>YEM-H4331</p>  <p>三一高压圆插(短)</p>	<p>YEM-H4332</p>  <p>三一高压扁插(短)</p>
<p>YEM-H4333</p>  <p>三一低压圆插(短)</p>	<p>YEM-H4334</p>  <p>三一低压扁插(短)</p>	<p>YEM-H4335</p>  <p>力士乐低压 (R9026038711)</p>	<p>YEM-H4336</p>  <p>J05共轨压力传感器</p>
<p>YEM-H4337</p>  <p>PC-8共轨压力传感器</p>	<p>YEM-H4338</p>  <p>力士乐高压 (R902603031)</p>	<p>YEM-H4339</p>  <p>三一新款低压</p>	<p>YEM-H4340</p>  <p>三一新款高压</p>
<p>YEM-H4341</p>  <p>压力开关</p>	<p>YEM-H4342</p>  <p>2746718</p>	<p>YEM-H4343</p>  <p>383-7548</p>	<p>YEM-H4344</p>  <p>VOLVO360机油压力传感器</p>
<p>YEM-H4345</p>  <p>康明斯</p>	<p>YEM-H4346</p>  <p>4921475</p>	<p>YEM-H4347</p>  <p>4921473</p>	<p>YEM-H4348</p>  <p>4HK1/6HK1 温度传感器</p>

压力传感器 PRESSURE SWITCH

<p>YEM-H4349</p>  <p>高压油泵传感器</p>	<p>YEM-H4350</p>  <p>SY215-8 高压压力传感器(优质)</p>	<p>YEM-H4351</p>  <p>SY215-8 低压压力传感器(优质)</p>	<p>YEM-H4352</p>  <p>SH200A2/3 细牙压力开关(优质) 20PS597-7C</p>
<p>YEM-H4353</p>  <p>R225-7 压力开关(优质) 20PS981-2 31E5-40500</p>	<p>YEM-H4354</p>  <p>R225-7 压力开关(优质) 20PS981-5 31E5-40560</p>	<p>YEM-H4355</p>  <p>EX200-5 压力开关 4353686</p>	<p>YEM-H4356</p>  <p>SH200A5 粗牙压力开关(优质) 20PS597-5A</p>
<p>YEM-H4357</p>  <p>SK-10 低压 52S00103P1</p>	<p>YEM-H4358</p>  <p>卡特D型 (方插)</p>	<p>YEM-H4359</p>  <p>液压油传感器</p>	<p>YEM-H4360</p>  <p>三一共轨压力传感器 0281006322</p>
<p>YEM-H4361</p>  <p>龙工高压(方插)</p>	<p>YEM-H4362</p>  <p>龙工低压(方插)</p>	<p>YEM-H4363</p>  <p>龙工高压(扁插)</p>	<p>YEM-H4364</p>  <p>龙工低压(扁插)</p>
<p>YEM-H4365</p>  <p>PC200-6 高压压力传感器(优质) 7861-92-1610</p>	<p>YEM-H4366</p>  <p>住友倒车灯开关</p>	<p>YEM-H4367</p>  <p>332/J0671 332/J0670 332/J0869</p>	<p>YEM-H4368</p>  <p>压力发讯器</p>

压力传感器 PRESSURE SWITCH

转速感应器 REVOLUTION SENSOR

<p>YEM-H4369</p>  <p>E320D 高压压力传感器(优质) 221-8859</p>	<p>YEM-H4370</p>  <p>HD512、820 高压压力传感器(优质) PT-W-8Z</p>	<p>YEM-H4371</p>  <p>E320C/B 高压压力传感器(优质) 221-8859</p>	<p>YEM-H4372</p>  <p>CAT-D型 压力开关 309-5795</p>
<p>YEM-H4373</p>  <p>E320A/312B 大圆压力开关(优质) 126-2938X03</p>	<p>YEM-H4374</p>  <p>SK 国产机压力开关</p>	<p>YEM-H4375</p>  <p>龙工、徐工、厦工 国产机型压力开关(优质)</p>	<p>YEM-H4376</p>  <p>CAT-D型 压力开关 309-5769</p>
<p>YEM-H4377</p>  <p>PC200-5 压力开关(优质) 20Y-06-15190</p>	<p>YEM-H4378</p>  <p>E330B/C 小方压力开关(优质) 106-0179X03</p>	<p>YEM-H4379</p>  <p>E320 小圆压力开关(优质) 119-9985X01</p>	<p>YEM-H4380</p>  <p>E320B/C 大方压力开关(优质) 106-0180X02</p>
<p>YEM-H4381</p>  <p>燃油压力传感器 237-0957</p>	<p>YEM-H4382</p>  <p>PC-8油杯传感器 OEM 600-311-3721</p>	<p>YEM-H4383</p>  <p>C9 喷油自动压力传感器 224-4536</p>	<p>YEM-H4384</p>  <p>E325 机油压力传感器 OEM:194-6725</p>
<p>YEM-H4385</p>  <p>C9 燃油共轨压力传感器 224-4535</p>	<p>YEM-H4386</p>  <p>液压传感器</p>	<p>YEM-H4387</p>  <p>小松行走开关</p>	<p>YEM-H4388</p>  <p>EX200-2/3 液压传感器 4259333</p>
<p>YEM-H4389</p>  <p>徐工(大)液压油传感器</p>	<p>YEM-H4390</p>  <p>徐工(小)液压油传感器</p>	<p>YEM-H4391</p>  <p>传感器 600bar</p>	<p>YEM-H4392</p>  <p>Sk 液压油传感器 SENSOR</p>

<p>YEM-H4393</p>  <p>E320D 正时转速传感器 238-0120</p>	<p>YEM-H4394</p>  <p>4JJ1 偏心轴转速传感器 8-97312108-1</p>	<p>YEM-H4395</p>  <p>凸轮轴传感器 CAMSHAFT SENSOR J05E/J08E 029600-057</p>	<p>YEM-H4396</p>  <p>ISUZU 6BD1 转速传感器 REVOLUTION SENSOR</p>	
<p>YEM-H4397</p>  <p>转速传感器 VOLVO480 REVOLUTION SENSOR</p>	<p>YEM-H4398</p>  <p>转速传感器 VOE20482772 VOLVO210/240/290 REVOLUTION SENSOR</p>	<p>YEM-H4399</p>  <p>转速传感器 VOE20450707 VOLVO210/240/290 REVOLUTION SENSOR</p>	<p>YEM-H4400</p>  <p>VOLVO210 老款进气压力传感器 20450693 REVOLUTION SENSOR</p>	
<p>YEM-H4401</p>  <p>VOLVO140 转速传感器(短)</p>	<p>YEM-H4402</p>  <p>VOLVO140 转速传感器(长)</p>	<p>YEM-H4403</p>  <p>VOLVO380 转速传感器</p>	<p>YEM-H4404</p>  <p>6HK1/4HK1 98014831-0 凸轮轴传感器</p>	
<p>YEM-H4405</p>  <p>6HK1/4HK1 8-97306113-1 转速传感器 REVOLUTION SENSOR</p>	<p>YEM-H4406</p>  <p>VOLVO210/240/290 进气压力传感器</p>	<p>YEM-H4407</p>  <p>J05 S8941-01570 副转速传感器 REVOLUTION SENSOR</p>	<p>YEM-H4408</p>  <p>PC200-8 凸轮轴传感器</p>	<p>YEM-H4409</p>  <p>PC130-8 凸轮轴传感器</p>
<p>YEM-H4410</p>  <p>SK350-8/PC450-8 凸轮轴传感器</p>	<p>YEM-H4411</p>  <p>C7/C9 传感器</p>	<p>YEM-H4412</p>  <p>PC200-8 6261-81-1900 报警压力传感器</p>	<p>YEM-H4413</p>  <p>PC-8 进气压力传感器</p>	<p>YEM-H4414</p>  <p>6HK1、J05/J08 大气压力传感器 079800-5590</p>

转速感应器 REVOLUTION SENSOR

转速感应器 REVOLUTION SENSOR

<p>YEM-H4415</p>  <p>R220-5 21E3-0042 转速传感器 Revolution sensor</p>	<p>YEM-H4416</p>  <p>DH220-5 转速传感器 2547-1015 Revolution sensor</p>	<p>YEM-H4417</p>  <p>Sh住友转速传感器 Revolution sensor</p>	<p>YEM-H4418</p>  <p>R225-7 转速传感器 Revolution sensor</p>	
<p>YEM-H4419</p>  <p>转速传感器 Revolution Sensor EX200-1/2/3/5 Ex120 4265372</p>	<p>YEM-H4420</p>  <p>玉柴转速传感器 Pressure Switch</p>	<p>YEM-H4421</p>  <p>转速传感器</p>	<p>YEM-H4422</p>  <p>转速传感器</p>	
<p>YEM-H4423</p>  <p>转速传感器</p>	<p>YEM-H4424</p>  <p>传感器</p>	<p>YEM-H4425</p>  <p>发讯器 VM5C.0</p>	<p>YEM-H4426</p>  <p>制动灯开关总成</p>	
<p>YEM-H4427</p>  <p>VOLVO真空开关</p>	<p>YEM-H4428</p>  <p>D6E VOE2139 1697</p>	<p>YEM-H4429</p>  <p>VOLVO360 146013801480 VOE11423761</p>	<p>YEM-H4430</p>  <p>D7E VOE21391695</p>	
<p>YEM-H4431</p>  <p>VOLVO360 凸轮轴传感器</p>	<p>YEM-H4432</p>  <p>VOLVO210 备用开关 (VOE14616040)</p>	<p>YEM-H4433</p>  <p>沃尔沃4线备用开关 VOE14626841 VOE14671313 VOE14578492</p>	<p>YEM-H4434</p>  <p>沃尔沃2线备用开关 VOE14502170</p>	<p>YEM-H4435</p>  <p>VOE11170071</p>

<p>YEM-H4436</p>  <p>VOE21042447</p>	<p>YEM-H4437</p>  <p>VOLVO 传感器 11170090 PRESSURE SWITCH</p>	<p>YEM-H4438</p>  <p>柳工 转速传感器</p>	<p>YEM-H4439</p>  <p>住友液压油传感器 Sensor</p>
<p>YEM-H4440</p>  <p>转速传感器 Revolution sensor</p>	<p>YEM-H4441</p>  <p>PC200-7 空滤传感器 Pressure Switch</p>	<p>YEM-H4442</p>  <p>PC200-3/5/6 PC220-6 6D102 7861-92-2310 转速传感器 Revolution Sensor</p>	<p>YEM-H4443</p>  <p>PC200-7 转速传感器 7861-93-2310</p>
<p>YEM-H4444</p>  <p>E200B E320 196-7973/125-2966 转速传感器 Revolution Sensor</p>	<p>YEM-H4445</p>  <p>E330C 转速传感器 4P 5820</p>	<p>YEM-H4446</p>  <p>E330D 转速传感器</p>	<p>YEM-H4447</p>  <p>E320BC 转速传感器 125-2966</p>
<p>YEM-H4448</p>  <p>SK200-8 转速传感器 Revolution sensor</p>	<p>YEM-H4449</p>  <p>SK200-3/5 ME 845235 转速传感器 Revolution sensor</p>	<p>YEM-H4450</p>  <p>SK200-6E 转速传感器 MC849577</p>	<p>YEM-H4451</p>  <p>三一 转速传感器 7240-A-015 SK200-8 转速传感器 VHS894101290</p>
<p>YEM-H4452</p>  <p>凯斯/住友 A3 液压安全锁开关</p>	<p>YEM-H4453</p>  <p>凯斯/住友 A5 液压安全锁开关</p>	<p>YEM-H4454</p>  <p>SK200-8 转速传感器 VHS894101290</p>	<p>YEM-H4455</p>  <p>EC360 转速传感器</p>

水温感应器 WATER TEMP SENSOR

<p>YEM-H4456</p>  <p>SK350-8水温感应器 SK350-8 J08E S8346-01510 WATER TEMP SENSOR</p>	<p>YEM-H4457</p>  <p>SK200-3/5水温感应器 SK200-3/5 SW2489V268F1 WATER TEMP SENSOR</p>	<p>YEM-H4458</p>  <p>SK200-6E水温感应器 SK200-6/6E YT52S00001P1 WATER TEMP SENSOR</p>	<p>YEM-H4459</p>  <p>SK200-8水温感应器 SK200-8 S8342-01250 WATER TEMP SENSOR</p>
<p>YEM-H4460</p>  <p>水温报警器(双插) SK200-6 HD700-7 6D31/6D34 ME049 265 WATER TEMP SENSOR</p>	<p>YEM-H4461</p>  <p>水温报警器(单插) SK200-6 HD700-7 6D31/6D34 ME049 265 WATER TEMP SENSOR</p>	<p>YEM-H4462</p>  <p>卡特320D水温感应器 E320D WATER TEMP SENSOR</p>	<p>YEM-H4463</p>  <p>卡特330C水温感应器 E325/E330C 264-4297 WATER TEMP SENSOR</p>
<p>YEM-H4464</p>  <p>卡特320B水温感应器(优) E320/E320B/E320C 51-7578 34390-00800 2979315 WATER TEMP SENSOR</p>	<p>YEM-H4465</p>  <p>卡特320B水温感应器 E320B 51-7578 34390-00800 2644297 WATER TEMP SENSOR</p>	<p>YEM-H4466</p>  <p>卡特330B水温感应器 E330B WATER TEMP SENSOR 卡特320C油温传感器 E320C HYD DIL TEMP SENSOR</p>	<p>YEM-H4467</p>  <p>ZAX330水温感应器 ZAX330 8-97217444-1 WATER TEMP SENSOR</p>
<p>YEM-H4468</p>  <p>SH350A5水温感应器 SH350A5 8-98023717-0 WATER TEMP SENSOR</p>	<p>YEM-H4469</p>  <p>SH200A3水温感应器 SH200A3 179730-0040 WATER TEMP SENSOR</p>	<p>YEM-H4470</p>  <p>ZAX55 水温感应器 WATER TEMP SENSOR</p>	<p>YEM-H4471</p>  <p>PC400-6水温感应器 PC400-6 3915329 WATER TEMP SENSOR</p>
<p>YEM-H4472</p>  <p>PC200-8水温感应器 PC200-8 WATER TEMP SENSOR</p>	<p>YEM-H4473</p>  <p>JCB水温传感器 701/80389 WATER TEMP SENSOR</p>	<p>YEM-H4474</p>  <p>JCB水温传感器 701/80324 WATER TEMP SENSOR</p>	<p>YEM-H4475</p>  <p>JCB水温传感器 716/30126 WATER TEMP SENSOR</p>

水温感应器 WATER TEMP SENSOR

<p>YEM-H4476</p>  <p>JCB水温传感器 701/80627 WATER TEMP SENSOR</p>	<p>YEM-H4477</p>  <p>JCB水温传感器 701/80317 WATER TEMP SENSOR</p>	<p>YEM-H4478</p>  <p>JCB水温传感器 WATER TEMP SENSOR</p>	<p>YEM-H4479</p>  <p>JCB水温传感器 WATER TEMP SENSOR</p>
<p>YEM-H4480</p>  <p>CAT水温传感器 2566453 WATER TEMP SENSOR</p>	<p>YEM-H4481</p>  <p>日立200-5水温报警器 EX200-5 8-97125601-1 WATER TEMP SENSOR</p>	<p>YEM-H4482</p>  <p>日立水温感应器 EX200-2/5 4257129 WATER TEMP SENSOR</p>	<p>YEM-H4483</p>  <p>ZAX电喷水温报警器 ZAX电喷 8-97170327-0 WATER TEMP SENSOR</p>
<p>YEM-H4484</p>  <p>现代200水温感应器 R220-5/7 21EN-40100 WATER TEMP SENSOR</p>	<p>YEM-H4485</p>  <p>大宇水温传感器 DH220-5 2547-9038 WATER TEMP SENSOR</p>	<p>YEM-H4486</p>  <p>现代60-7水温感应器 R60-7 WATER TEMP SENSOR</p>	<p>YEM-H4487</p>  <p>通用水温感应器(单插) ISUZU TOYOTA 4BD1 WATER TEMP SENSOR</p>
<p>YEM-H4488</p>  <p>通用水温感应器(双插) MITSUBISHI ISUZU WATER TEMP SENSOR</p>	<p>YEM-H4489</p>  <p>厦工水温感应器 3015238 WATER TEMP SENSOR</p>	<p>YEM-H4490</p>  <p>洋马水温感应器 YANMAR 121250-44901 WATER TEMP SENSOR</p>	<p>YEM-H4491</p>  <p>洋马水温感应器(小) YANMAR WATER TEMP SENSOR</p>
<p>YEM-H4492</p>  <p>VOLVO水温感应器 VOLVO VOE20513340 VOE21531072 WATER TEMP SENSOR</p>	<p>YEM-H4493</p>  <p>油温度报警开关</p>	<p>YEM-H4494</p>  <p>PC360-7水温感应器 PC360-7 PC450-7/8 7861-93-3520 WATER TEMP SENSOR</p>	<p>YEM-H4495</p>  <p>PC200-5水温感应器 PC200-5 7861-92-3320 WATER TEMP SENSOR</p>

水温感应器 WATER TEMP SENSOR

<p>YEM-H4496</p>  <p>VOLVO210副水箱传感器</p>	<p>YEM-H4497</p>  <p>PC200-7水温感应器 PC200-7 7861-93-3320 WATER TEMP SENSOR</p>	<p>YEM-H4498</p>  <p>水温传感器</p>	<p>YEM-H4499</p>  <p>PC200-6水温感应器(优) PC200-6/6D102 PC220-6 7861-92-3380 WATER TEMP SENSOR</p>
<p>YEM-H4500</p>  <p>VOLVO480油温传感器</p>	<p>YEM-H4501</p>  <p>卡特320C水温传感器 E320C 135-2336 34390-02200 WATER TEMP SENSOR</p>	<p>YEM-H4502</p>  <p>SHA5水温感应器(带线) SHA5 WATER TEMP SENSOR</p>	<p>YEM-H4503</p>  <p>住友水温感应器 SH200-3 KHR1017 WATER TEMP SENSOR</p>
<p>YEM-H4504</p>  <p>VOLVO水温感应器 EC210B/290B 螺牙16mm WATER TEMP SENSOR</p>	<p>YEM-H4505</p>  <p>VOLVO水温感应器 EC210B/290B 螺牙18mm WATER TEMP SENSOR</p>	<p>YEM-H4506</p>  <p>ZAX200水温报警器 ZAX200 4371318 1-83161033-0 WATER TEMP SENSOR</p>	<p>YEM-H4507</p>  <p>日立200-2/3水温感应器 EX200-2/3 1-83161019-1 WATER TEMP SENSOR</p>
<p>YEM-H4508</p>  <p>6HK1水温传感器 6HK1 WATER TEMP SENSOR</p>	<p>YEM-H4509</p>  <p>水温感应器 WATER TEMP SENSOR</p>	<p>YEM-H4510</p>  <p>水温感应器 WATER TEMP SENSOR</p>	<p>YEM-H4511</p>  <p>水温感应器 WATER TEMP SENSOR</p>
<p>YEM-H4512</p>  <p>水温感应器 WATER TEMP SENSOR</p>	<p>YEM-H4513</p>  <p>VOLVO360副水箱传感器</p>	<p>YEM-H4514</p>  <p>VOLVO210新款副水箱传感器</p>	<p>YEM-H4515</p>  <p>水位报警开关</p>

机油感应器 OIL PRESSURE SWITCH

<p>YEM-H4516</p>  <p>VOLVO17202022机油感应器 OIL PRESSURE SWITCH</p>	<p>YEM-H4517</p>  <p>卡特机油感应器 E320C 51-8005 34390-40200 OIL PRESSURE SWITCH</p>	<p>YEM-H4518</p>  <p>洋马机油感应器 YANNAR OIL PRESSURE SWITCH</p>	<p>YEM-H4519</p>  <p>通用机油感应器 OIL PRESSURE SWITCH</p>
<p>YEM-H4520</p>  <p>通用单脚机油感应器 EX200-5 PC HD 6732-81-3140 08073-10505 OIL PRESSURE SWITCH</p>	<p>YEM-H4521</p>  <p>通用双脚机油感应器 EX200-5 6732-81-3140 08073-10505 OIL PRESSURE SWITCH</p>	<p>YEM-H4522</p>  <p>通用单脚机油感应器(进口) EX200-5 PC HD 6732-81-3140 08073-10505 OIL PRESSURE SWITCH</p>	<p>YEM-H4523</p>  <p>大宇300机油感应器 DH300-5 65127441-7007</p>
<p>YEM-H4524</p>  <p>4JG1机油感应器 OIL PRESSURE SWITCH</p>	<p>YEM-H4525</p>  <p>6BD1机油感应器 EX200-2/3/5 1-82410160-1 OIL PRESSURE SWITCH</p>	<p>YEM-H4526</p>  <p>6BG1机油感应器 6BG1 OIL PRESSURE SWITCH</p>	<p>YEM-H4527</p>  <p>柳工(铜)机油压力开关</p>
<p>YEM-H4528</p>  <p>SK200-8机油感应器 SK200-8 83530-E0220 OIL PRESSURE SWITCH</p>	<p>YEM-H4529</p>  <p>日立电喷机油感应器 ZAX电喷</p>	<p>YEM-H4530</p>  <p>VOLVO210新款机油感应器 EC210/EC240 20291011 04215774 OIL PRESSURE SWITCH</p>	<p>YEM-H4531</p>  <p>VOLVO210老款机油感应器</p>
<p>YEM-H4532</p>  <p>VOLVO460机油感应器 EC360/EC460 1077574 OIL PRESSURE SWITCH</p>	<p>YEM-H4533</p>  <p>ZAX电喷 机油压力传感器 499000-7341</p>	<p>YEM-H4534</p>  <p>PC200-8机油感应器 PC200-8 6744-81-4010 OIL PRESSURE SWITCH</p>	<p>YEM-H4535</p>  <p>VOLVO17202021机油感应器 OIL PRESSURE SWITCH</p>
<p>YEM-H4536</p>  <p>康明斯、福田 机油压力传感器 4921487</p>	<p>YEM-H4537</p>  <p>PC400-8 机油压力传感器 4921517</p>	<p>YEM-H4538</p>  <p>康明斯机油压力传感器(优) CUMMINS OIL PRESSURE SWITCH</p>	<p>YEM-H4539</p>  <p>康明斯机油压力传感器 CUMMINS OIL PRESSURE SWITCH</p>

机油感应器 OIL PRESSURE SWITCH

熄火开关 FLAMEOUT SOLENOID

<p>YEM-H4540</p>  <p>三一机油压力传感器 SANY 660804 OIL PRESSURE SWITCH</p>	<p>YEM-H4541</p>  <p>三一机油压力传感器 SANY 661204 OIL PRESSURE SWITCH</p>	<p>YEM-H4542</p>  <p>三一机油压力传感器 SANY 660404 OIL PRESSURE SWITCH</p>	<p>YEM-H4543</p>  <p>柳工机油压力传感器 CLG 30B0488 OIL PRESSURE SWITCH</p>
<p>YEM-H4544</p>  <p>柳工回转压力传感器 CLG 30B0272/661203 OIL PRESSURE SWITCH</p>	<p>YEM-H4545</p>  <p>VOLVO15193875</p>	<p>YEM-H4546</p>  <p>柳工32316-398021 (1.6BAR)</p>	<p>YEM-H4547</p>  <p>631003</p>
<p>YEM-H4548</p>  <p>661003</p>	<p>YEM-H4549</p>  <p>凯斯240 (4921497)</p>	<p>YEM-H4550</p>  <p>卡特320C机油油位传感器 OILPRESSURE SWITCH</p>	<p>YEM-H4551</p>  <p>卡特330C传感器 SENSOR</p>
<p>YEM-H4552</p>  <p>卡特330B机油感应器 3E-6455 OIL PRESSURE SWITCH</p>	<p>YEM-H4553</p>  <p>机油感应器 170530(20BAR)</p>	<p>YEM-H4554</p>  <p>机油感应器 170530(15BAR)</p>	<p>YEM-H4555</p>  <p>柳工机油感应器</p>
<p>YEM-H4556</p>  <p>机油感应器 OIL PRESSURE SWITCH</p>	<p>YEM-H4557</p>  <p>PC60-7 PC200-6 PC300-6 先导液压开关</p>	<p>YEM-H4558</p>  <p>ZAX30/E305/E306/E307/PC56 先导液压开关</p>	<p>YEM-H4559</p>  <p>小松PC-5/-6 油底壳油位传感器 OIL PRESSURE SWITCH</p>
<p>YEM-H4560</p>  <p>小松PC200-7 油底壳油位传感器 OIL PRESSURE SWITCH</p>	<p>YEM-H4561</p>  <p>小松PC200-8 油底壳油位传感器 OIL PRESSURE SWITCH</p>	<p>YEM-H4562</p>  <p>日立EX 油底壳油位传感器 OIL PRESSURE SWITCH</p>	<p>YEM-H4563</p>  <p>神钢SK 油底壳油位传感器 OIL PRESSURE SWITCH</p>

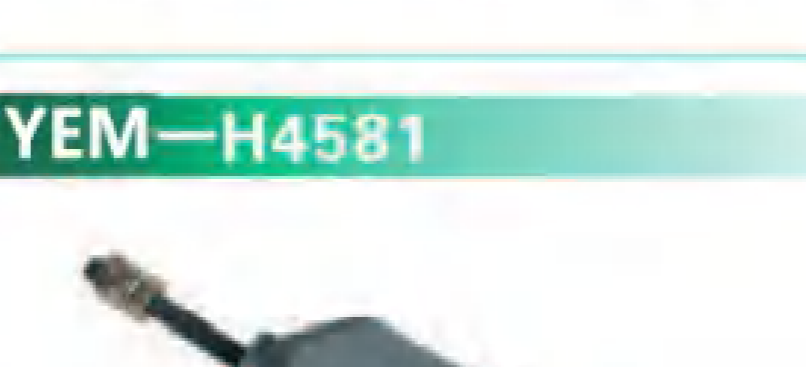
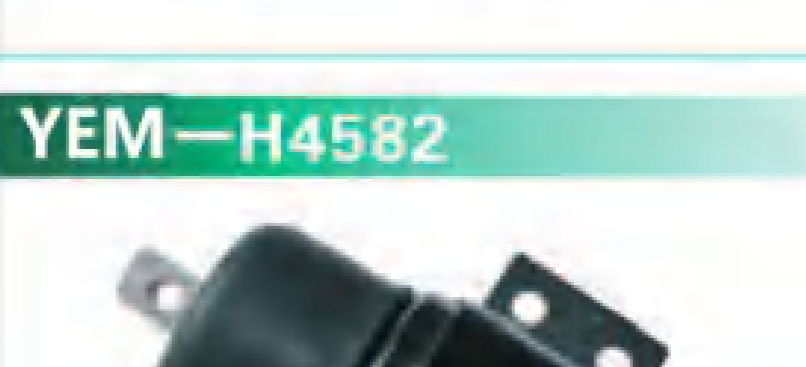
<p>YEM-H4564</p>  <p>PC360-7 4063712 6734-81-9141</p>	<p>YEM-H4565</p>  <p>PC300-6 3930234 6742-01-2310</p>	<p>YEM-H4566</p>  <p>大洋马 1751ES-12A3UC12BIS</p>	<p>YEM-H4567</p>  <p>3932530 24V 3932529 12V</p>
<p>YEM-H4568</p>  <p>R130 3991168 24V 3991167 12V</p>	<p>YEM-H4569</p>  <p>6CT 3935650 24V 3935649 12V</p>	<p>YEM-H4570</p>  <p>3932545 12V 3932546 24V</p>	<p>YEM-H4571</p>  <p>37236-56010 24V</p>
<p>YEM-H4572</p>  <p>RSV1751 SA3765-24 24V</p>	<p>YEM-H4573</p>  <p>3415706 24V</p>	<p>YEM-H4574</p>  <p>3939019 24V</p>	<p>YEM-H4575</p>  <p>3928161 24V 3928160 12V</p>
<p>YEM-H4576</p>  <p>3921980 24V</p>	<p>YEM-H4577</p>  <p>B4002-1115030 24V</p>	<p>YEM-H4578</p>  <p>DH220-5 11N6-66030 24V</p>	<p>YEM-H4579</p>  <p>R210 11E1-60100 24V</p>
<p>YEM-H4580</p>  <p>A036-3175 12V</p>	<p>YEM-H4581</p>  <p>R215-7/R225-7 3864274 24V</p>	<p>YEM-H4582</p>  <p>HD800/900 HD250/450 ME040145 053400-73500</p>	<p>YEM-H4583</p>  <p>D59-105-05 24V</p>

熄火开关 FLAMEOUT SOLENOID

<p>YEM-H4584</p>  <p>SA-4752-12</p>	<p>YEM-H4585</p>  <p>25-38109-05Z(12V)</p>	<p>YEM-H4586</p>  <p>42-100(12V)</p>	<p>YEM-H4587</p>  <p>1G925-60011 (12V)</p>
<p>YEM-H4588</p>  <p>U85206452 (12V)</p>	<p>YEM-H4589</p>  <p>EHB4813-1 (12V)</p>	<p>YEM-H4590</p>  <p>D59-105-01 SD-223(12V)</p>	<p>YEM-H4591</p>  <p>ZSF-3C</p>
<p>YEM-H4592</p>  <p>1502-12C3U1B1SA(12V)</p>	<p>YEM-H4593</p>  <p>1502-12C3U1B1S1(12V)</p>	<p>YEM-H4594</p>  <p>1502-12C2U1B2S1A(12V)</p>	<p>YEM-H4595</p>  <p>1502-12D6U1B1S1A(12V)</p>
<p>YEM-H4596</p>  <p>1504-12C2U1B1S1(12V)</p>	<p>YEM-H4597</p>  <p>1502ES-12C7U1B2S1(12V)</p>	<p>YEM-H4598</p>  <p>129953-77811 1751ES-12A3UC1281S(12V)</p>	<p>YEM-H4599</p>  <p>1752ES-24E7UC3B1S7(24V)</p>
<p>YEM-H4600</p>  <p>1753-12E2U1BS1(12V)</p>	<p>YEM-H4601</p>  <p>2001-126U1B2S1A(12V)</p>	<p>YEM-H4602</p>  <p>2001-12E2U1B1S1(12V)</p>	<p>YEM-H4603</p>  <p>232C-1115030A 24V</p>





















熄火开关 FLAMEOUT SOLENOID

<p>YEM-H4604</p>  <p>F3400-1115100B 玉柴4F90</p>	<p>YEM-H4605</p>  <p>8905200031 B3.3(12V) B3.3(24V) Oil Inlet Valve</p>	<p>YEM-H4606</p>  <p>37B34-56010 CUMMINS(24V)</p>	<p>YEM-H4607</p>  <p>37Z36-56010 CUMMINS(24V)</p>
<p>YEM-H4608</p>  <p>3935649(12V) 3935650(24V) CUMMINS 6CT(12V/24V)</p>	<p>YEM-H4609</p>  <p>3991625 CUMMINS 6BT 5.9L(24V) SA-4959-24</p>	<p>YEM-H4610</p>  <p>CUMMINS (24V) SA-4813-24 AUMAN</p>	<p>YEM-H4611</p>  <p>CUMMINS (24V) SD-008A2-24</p>
<p>YEM-H4612</p>  <p>CUMMINS (24V) RSV 1752ES SA-4014-24</p>	<p>YEM-H4613</p>  <p>3629411(12V) 3629412(24V) CUMMINS</p>	<p>YEM-H4614</p>  <p>3990773 CUMMINS</p>	<p>YEM-H4615</p>  <p>3977620</p>
<p>YEM-H4616</p>  <p>2003-24E2U1B1S1A(12V)</p>	<p>YEM-H4617</p>  <p>2003-24E2U1B1S1A(24V)</p>	<p>YEM-H4618</p>  <p>SA-2606-A(12V)</p>	<p>YEM-H4619</p>  <p>SA-2696-A(24V)</p>
<p>YEM-H4620</p>  <p>3906398 CUMMINS 12V</p>	<p>YEM-H4621</p>  <p>3906776 CUMMINS 24V</p>	<p>YEM-H4622</p>  <p>G20A1115030</p>	<p>YEM-H4623</p>  <p>1503ES-12A5SUC9SCC28</p>

熄火开关 FLAMEOUT SOLENOID

熄火开关 FLAMEOUT SOLENOID





<p>YEM-H4624</p>  <p>EX55 897329-5680 12V SK75 897209-1152 24V</p>	<p>YEM-H4625</p>  <p>SA-4735-24 24V</p>	<p>YEM-H4626</p>  <p>3932329</p>	<p>YEM-H4627</p>  <p>洋马熄火开关 R55/60 DH55/60 PC40/50 1503ES-12S5SUC12S 12V 1503ES-24S5SUC12S 24V 119233-77932</p>
<p>YEM-H4628</p>  <p>洋马熄火开关(白插) 1503ES-12S5SUC5S 12V</p>	<p>YEM-H4629</p>  <p>通用熄火开关 S6K E200B E320 HD700-5/7 6D31/6D34 SPA90902NI 1751-2467UIBIS5A 24V</p>	<p>YEM-H4630</p>  <p>通用熄火开关(优) S6K E200B E320 HD700-5/7 6D31/6D34 SPA90902NI 1751-2467UIBIS5A 24V</p>	<p>YEM-H4631</p>  <p>E330/E330B/E330C 155-4653 3E-9785</p>
<p>YEM-H4632</p>  <p>E325 155-4652</p>	<p>YEM-H4633</p>  <p>CAT 110-6465</p>	<p>YEM-H4634</p>  <p>CAT 155-5774 24V 155-5773 12V</p>	<p>YEM-H4635</p>  <p>大宇熄火电机 DH220/225 2523-9016 24V DH55/60 2523-9017 12V</p>
<p>YEM-H4636</p>  <p>住友/大宇 通用熄火开关 SH/DH</p>	<p>YEM-H4637</p>  <p>三一235/徐工熄火电机 SY235</p>	<p>YEM-H4638</p>  <p>三一215-8熄火电机 SY215-8</p>	<p>YEM-H4639</p>  <p>福田 12V E048331000093</p>
<p>YEM-H4640</p>  <p>1503ES-12A5UC5S 12V SA-4569-T</p>	<p>YEM-H4641</p>  <p>1503ES-12S5SUC11S 12V SA-4820</p>	<p>YEM-H4642</p>  <p>1503ES SA-4310-T 12V</p>	<p>YEM-H4643</p>  <p>3935430 24V SA-4755-24</p>

<p>YEM-H4644</p>  <p>久保田熄火开关 PC56 1A021-60010</p>	<p>YEM-H4645</p>  <p>久保田熄火开关 1G772-60012</p>	<p>YEM-H4646</p>  <p>久保田熄火开关 1C010-60015</p>	<p>YEM-H4647</p>  <p>久保田熄火开关 17208-60016</p>
<p>YEM-H4648</p>  <p>玉柴 6108-1115030 24V</p>	<p>YEM-H4649</p>  <p>3054611</p>	<p>YEM-H4650</p>  <p>3054608</p>	<p>YEM-H4651</p>  <p>3035334</p>
<p>YEM-H4652</p>  <p>2848A278 12V</p>	<p>YEM-H4653</p>  <p>3921978 12V</p>	<p>YEM-H4654</p>  <p>1751ES SA-3725 12V</p>	<p>YEM-H4655</p>  <p>1503ES-12A5SUC9S 12V SA-5019</p>
<p>YEM-H4656</p>  <p>DT 118 24V 612600080681</p>	<p>YEM-H4657</p>  <p>2848A275 12V SA-4934-12</p>	<p>YEM-H4658</p>  <p>SA4981-12</p>	<p>YEM-H4659</p>  <p>4942879</p>
<p>YEM-H4660</p>  <p>山猫 15471-60010 12V</p>	<p>YEM-H4661</p>  <p>16851-60014</p>	<p>YEM-H4662</p>  <p>16271-60012</p>	<p>YEM-H4663</p>  <p>37V78-56010 P612-B5V24 24V</p>

点火开关 VARIOUS LGNITION SWITCH

点火开关 VARIOUS LGNITION SWITCH

<p>YEM-H4664</p>  <p>山河智能</p>	<p>YEM-H4665</p>  <p>中联重科</p>	<p>YEM-H4666</p>  <p>柳工922D</p>	<p>YEM-H4667</p>  <p>ISC-8</p>
<p>YEM-H4668</p>  <p>ISC-8套筒式</p>	<p>YEM-H4669</p>  <p>夏工</p>	<p>YEM-H4670</p>  <p>玉柴</p>	<p>YEM-H4671</p>  <p>斗山电源开关</p>
<p>YEM-H4672</p>  <p>雷沃</p>	<p>YEM-H4673</p>  <p>龙工</p>	<p>YEM-H4674</p>  <p>临工</p>	<p>YEM-H4675</p>  <p>山猫</p>
<p>YEM-H4676</p>  <p>斗山带线</p>	<p>YEM-H4677</p>  <p>洋马</p>	<p>YEM-H4678</p>  <p>久保田短</p>	<p>YEM-H4679</p>  <p>久保田长</p>
<p>YEM-H4680</p>  <p>力士德</p>	<p>YEM-H4681</p>  <p>久保田</p>	<p>YEM-H4682</p>  <p>久保田688</p>	<p>YEM-H4683</p>  <p>VOLVO</p>

<p>YEM-H4684</p>  <p>卡特 二线电源开关</p>	<p>YEM-H4685</p>  <p>VOLVO 2线带手柄</p>	<p>YEM-H4686</p>  <p>VOLVO 2线带钥匙</p>
<p>YEM-H4687</p>  <p>现代 4线带手柄</p>	<p>YEM-H4688</p>  <p>现代 4线带钥匙</p>	<p>YEM-H4689</p>  <p>320BC 2线点火开关 7N0718</p>
<p>YEM-H4690</p>  <p>CAT 3线 点火开关2S2342</p>	<p>YEM-H4691</p>  <p>3线长 点火开关 7N4160 9W1077</p>	<p>YEM-H4692</p>  <p>E320C 4线 点火开关 9G7641</p>
<p>YEM-H4693</p>  <p>E200B 5线 点火开关 3E-0156</p>	<p>YEM-H4694</p>  <p>E320B 6线 点火开关 7Y3918</p>	<p>YEM-H4695</p>  <p>PC 点火开关 08086-10000</p>
<p>YEM-H4696</p>  <p>PC200-7 点火开关</p>	<p>YEM-H4697</p>  <p>EX200-1 点火开关 4186745</p>	<p>YEM-H4698</p>  <p>EX200-2/3/5 点火开关 4250350 14448303</p>

点火开关 VARIOUS LGNITION SWITCH

雨刮器总成 WIPER ASSY

YEM-H4699



ZAX电喷点火开关
4448303/4360297

YEM-H4700



SK点火开关
YN5000029F1

YEM-H4701



SK-8点火开关
YN50S00026F1

YEM-H4702



SH点火开关

YEM-H4703



SH电喷点火开关

YEM-H4704



DH55点火开关

YEM-H4705



DH 点火开关
2549-1153B
301419-00106

YEM-H4706



HD 点火开关
719-10305001

YEM-H4707



HD电喷点火开关

YEM-H4708



R 点火开关 21E610430

YEM-H4709



VOLVO 点火开关
14526158

YEM-H4710



三一 点火开关

YEM-H4711



烟斗 点火开关
007SS-54-3

YEM-H4712



JCB 点火开关
701/45500
701/80184

YEM-H4713



叉车

YEM-H4714



ZAX200-3 103° 24V

YEM-H4715



ZAX200-5
4369540 75° 24V

YEM-H4716



ZAX200-6
4453690 24V

YEM-H4717



ZAX-70 107° 24V

YEM-H4718



日立-450 110°

YEM-H4719



日立-70
WM-3310-IS 110° 24V

YEM-H4720



DAEWOO-7 24V
538-00009 2538-9013A 95°

YEM-H4721



DAEWOO-7 12V
538-00009 95°

YEM-H4722



DAEWOO 55 12V 95°
538-00005A F 00S 2B2 044

YEM-H4723



DAEWOO-60 70° 12V

YEM-H4724



DAEWOO-60 70° 12V

YEM-H4725



Dx380 90°

YEM-H4726



DX225-7 90°

YEM-H4727



柳工E系列 80°

YEM-H4728



柳工920D/922D/923D/925D
936D 80°

YEM-H4729



柳工904/905 12V 105°

YEM-H4730



柳工906/907/908 12V 105°

YEM-H4731



柳工LG906C/三一-200 80°

YEM-H4732



三一-55 24V 65°

YEM-H4733



三一-215 85°

雨刮器总成 WIPER ASSY













<p>YEM-H4734</p>  <p>山河挖机 12V 85°</p>	<p>YEM-H4735</p>  <p>山河230 24V 83°</p>	<p>YEM-H4736</p>  <p>VOLVO 480 24V 65°</p>	<p>YEM-H4737</p>  <p>VOLVO 210-360 24V 65°</p>
<p>YEM-H4738</p>  <p>VOLVO 55 12V</p>	<p>YEM-H4739</p>  <p>玉柴 12V 24V 90°</p>	<p>YEM-H4740</p>  <p>849100-0834 24V 105°</p>	<p>YEM-H4741</p>  <p>住友135 175° 24V</p>
<p>YEM-H4742</p>  <p>CATERPILLA 306 12V 105° 159200-5243</p>	<p>YEM-H4743</p>  <p>CATERPILLA 307 105° 259600-0441 CW 110 3J 24V</p>	<p>YEM-H4744</p>  <p>CATERPILLA 312 105° 159100-8152 24V 2R</p>	<p>YEM-H4745</p>  <p>CATERPILLA E320C 325 329 82° 24V</p>
<p>YEM-H4746</p>  <p>R220-7 现代 HYUNDAI 24V 90°</p>	<p>YEM-H4747</p>  <p>HYUNDAI 现代55 12V 95° 现代60-5</p>	<p>YEM-H4748</p>  <p>HYUNDAI 60-7 70° 12V</p>	<p>YEM-H4749</p>  <p>HYUNDAI 60-7 70° 12V</p>
<p>YEM-H4750</p>  <p>R220-5 现代 HYUNDAI 110° 24V</p>	<p>YEM-H4751</p>  <p>R220-7 现代 HYUNDAI 24V</p>	<p>YEM-H4752</p>  <p>KOMASTU-60-7 105° 24V</p>	<p>YEM-H4753</p>  <p>HD700-7 HD900-7 709-42501000 105° 24V</p>

雨刮器总成 WIPER ASSY

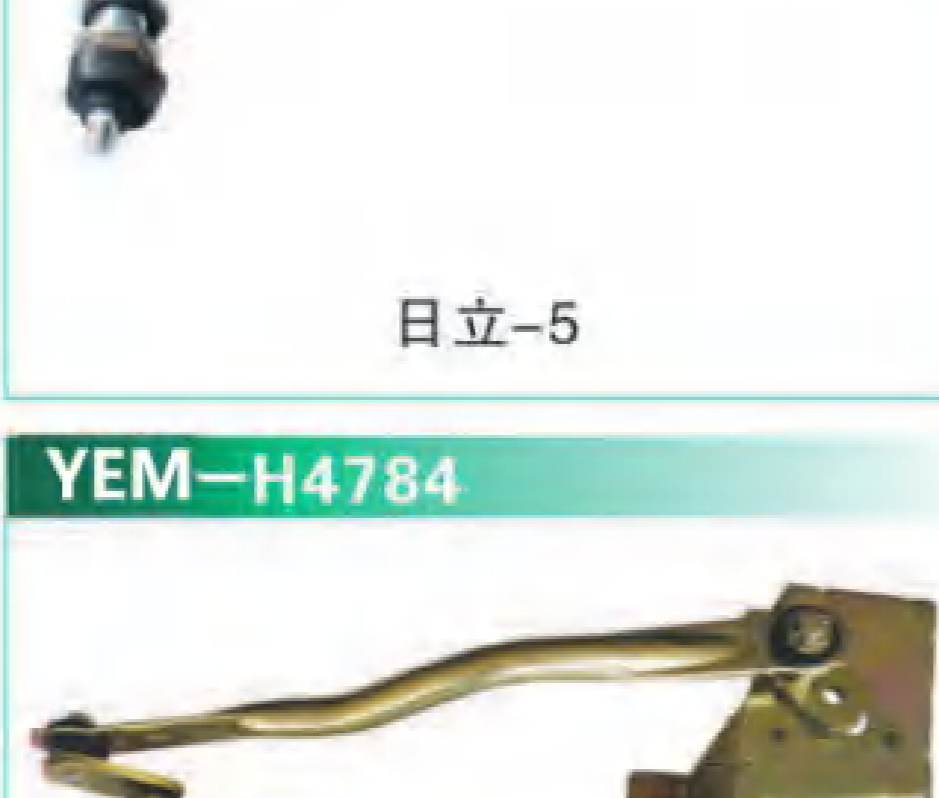
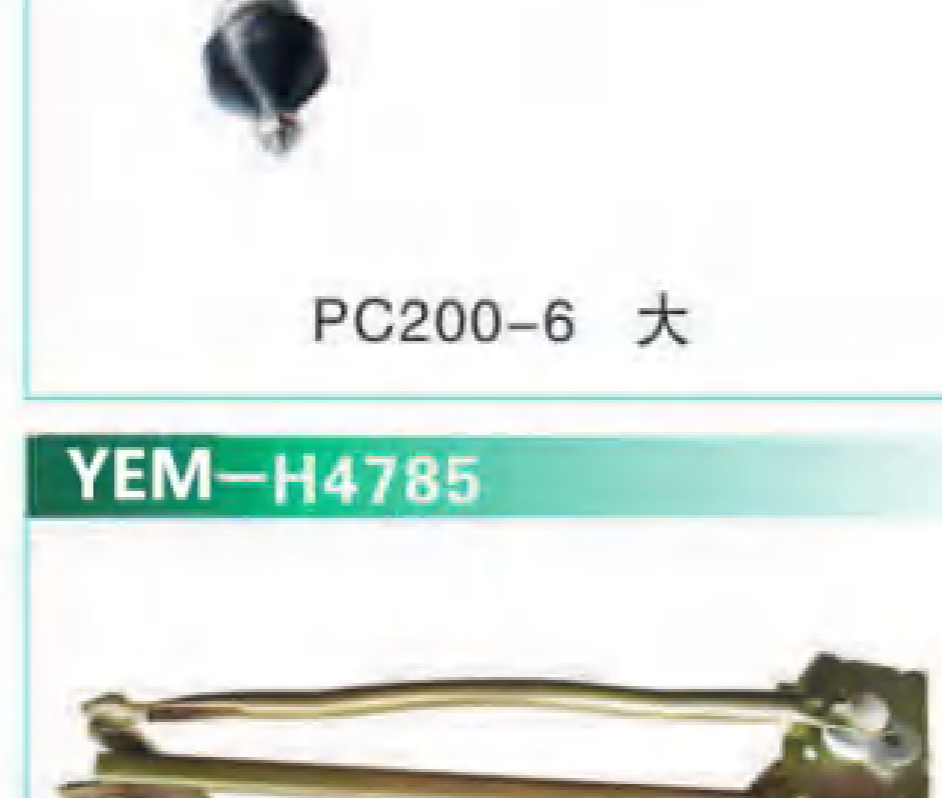
<p>YEM-H4754</p>  <p>HD820-1,709-47102001 24V HD820-3,709-48302001 105°</p>	<p>YEM-H4755</p>  <p>SH200-3 85° 24V</p>	<p>YEM-H4756</p>  <p>SHA1A2 105° 24V</p>	<p>YEM-H4757</p>  <p>PC200-3 105° 24V</p>
<p>YEM-H4758</p>  <p>PC200-5 105° 24V</p>	<p>YEM-H4759</p>  <p>PC200-6/6D102(大) 20Y-54-39402 85° 24V</p>	<p>YEM-H4760</p>  <p>PC200-7 20Y-54-52211 78° 24V</p>	<p>YEM-H4761</p>  <p>PC200-8 20Y-54-52211 78° 24V</p>
<p>YEM-H4762</p>  <p>PC200-6/6D95(小) 78° 24V</p>	<p>YEM-H4763</p>  <p>SK200-8 神钢 82° 24V</p>	<p>YEM-H4764</p>  <p>徐工 75° 24V</p>	<p>YEM-H4765</p>  <p>同力 95° 24V</p>
<p>YEM-H4766</p>  <p>吊机DC-24V 80W</p>	<p>YEM-H4767</p>  <p>单刮 12V 30W 85°</p>	<p>YEM-H4768</p>  <p>85° 24V</p>	<p>YEM-H4769</p>  <p>日立-6 24V</p>
<p>YEM-H4770</p>  <p>日立-5 24V</p>	<p>YEM-H4771</p>  <p>三一重工 24V</p>	<p>YEM-H4772</p>  <p>PC200-7 78° 24V</p>	<p>YEM-H4773</p>  <p>三一-55</p>

雨刮器总成 WIPER ASSY























雨刮器总成 WIPER ASSY

<p>YEM-H4774</p>  <p>沃尔沃480</p>	<p>YEM-H4775</p>  <p>沃尔沃480</p>	<p>YEM-H4776</p>  <p>沃尔沃</p>	<p>YEM-H4777</p>  <p>卡特E320C</p>
<p>YEM-H4778</p>  <p>神钢</p>	<p>YEM-H4779</p>  <p>PC200-7</p>	<p>YEM-H4780</p>  <p>日立-5</p>	<p>YEM-H4781</p>  <p>PC200-6 大</p>
<p>YEM-H4782</p>  <p>日立-6</p>	<p>YEM-H4783</p>  <p>连杆杆 三一215</p>	<p>YEM-H4784</p>  <p>连杆杆 山河挖机</p>	<p>YEM-H4785</p>  <p>连杆杆 徐工</p>
<p>YEM-H4786</p>  <p>连杆杆 现代-7</p>	<p>YEM-H4787</p>  <p>连杆杆 DX380</p>	<p>YEM-H4788</p>  <p>连杆杆 山河230</p>	<p>YEM-H4789</p>  <p>连杆杆 柳工E系列</p>
<p>YEM-H4790</p>  <p>柳工855-856 58°</p>	<p>YEM-H4791</p>  <p>柳工855 50C 58°</p>	<p>YEM-H4792</p>  <p>柳工(2530-3) 50CN 58°</p>	<p>YEM-H4793</p>  <p>柳工855 65°</p>

<p>YEM-H4794</p>  <p>龙工856(855B) 65°</p>	<p>YEM-H4795</p>  <p>成工30</p>	<p>YEM-H4796</p>  <p>临工 65°</p>	<p>YEM-H4797</p>  <p>厦工953-3</p>
<p>YEM-H4798</p>  <p>厦工951-3 92°</p>	<p>YEM-H4799</p>  <p>临工956(新款) 56°</p>	<p>YEM-H4800</p>  <p>临工953 56°</p>	<p>YEM-H4801</p>  <p>临工953(老款)</p>
<p>YEM-H4802</p>  <p>徐工500F 58°</p>	<p>YEM-H4803</p>  <p>徐工500K</p>	<p>YEM-H4804</p>  <p>柳工</p>	<p>YEM-H4805</p>  <p>龙工 95°</p>
<p>YEM-H4806</p>  <p>龙工长轴 95°</p>	<p>YEM-H4807</p>  <p>龙工 65°</p>	<p>YEM-H4808</p>  <p>厦工 65°</p>	<p>YEM-H4809</p>  <p>厦工 95°</p>
<p>YEM-H4810</p>  <p>厦工长轴 95°</p>	<p>YEM-H4811</p>  <p>日立200-6杆子 EX200-6</p>	<p>YEM-H4812</p>  <p>ZAX240-3雨刮电机齿轮 WIPER MOTOR GEAR</p>	<p>YEM-H4813</p>  <p>住友A5雨刮电机齿轮 WIPER MOTOR GEAR</p>

雨刮片 WIPER BLADE

电器件 ELECTRIC PARTS

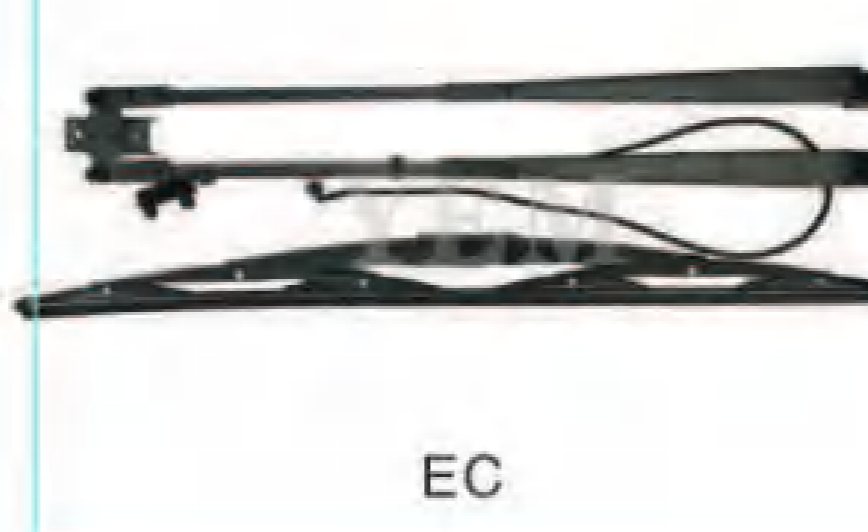
<p>YEM-H4814</p>  <p>PC200-6 6D95雨刮臂片</p>	<p>YEM-H4815</p>  <p>PC200-3/5</p>	<p>YEM-H4816</p>  <p>PC60-7</p>	
<p>YEM-H4817</p>  <p>PC200-6/7/8</p>	<p>YEM-H4818</p>  <p>EX200-1/2/3</p>	<p>YEM-H4819</p>  <p>EX200-5 ZAX电喷</p>	<p>YEM-H4820</p>  <p>EX200-6 ZAX直喷</p>
<p>YEM-H4821</p>  <p>EX70</p>	<p>YEM-H4822</p>  <p>E200B</p>	<p>YEM-H4823</p>  <p>E320/E312</p>	<p>YEM-H4824</p>  <p>E320C</p>
<p>YEM-H4825</p>  <p>DH55</p>	<p>YEM-H4826</p>  <p>DH60</p>	<p>YEM-H4827</p>  <p>DH220-5</p>	<p>YEM-H4828</p>  <p>SK200-3</p>
<p>YEM-H4829</p>  <p>SK200-5</p>	<p>YEM-H4830</p>  <p>SK200-6/8</p>	<p>YEM-H4831</p>  <p>HD700</p>	<p>YEM-H4832</p>  <p>HD820</p>
<p>YEM-H4833</p>  <p>SH200A3</p>	<p>YEM-H4834</p>  <p>SH200A1A2</p>	<p>YEM-H4835</p>  <p>R215-7</p>	<p>YEM-H4836</p>  <p>EC</p>

<p>YEM-H4837</p>  <p>备用开关 2线</p>	<p>YEM-H4838</p>  <p>备用开关 3线</p>	<p>YEM-H4839</p>  <p>备用开关 4线</p>	<p>YEM-H4840</p>  <p>备用开关 6线</p>	<p>YEM-H4841</p>  <p>备用开关 12线</p>
<p>YEM-H4842</p>  <p>PC二极管</p>	<p>YEM-H4843</p>  <p>大二极管</p>	<p>YEM-H4844</p>  <p>小二极管</p>	<p>YEM-H4845</p>  <p>DH断路器</p>	
<p>YEM-H4846</p>  <p>PC200-8保险丝盒子</p>	<p>YEM-H4847</p>  <p>PC200-7保险丝盒子</p>	<p>YEM-H4848</p>  <p>PC200-6保险丝盒子</p>	<p>YEM-H4849</p>  <p>PC200-5保险丝盒子</p>	
<p>YEM-H4850</p>  <p>大宇DH225-7保险丝盒子</p>	<p>YEM-H4851</p>  <p>大宇DH60-7 (四插) 保险丝盒子</p>	<p>YEM-H4852</p>  <p>神钢SK-2/3保险丝盒子</p>	<p>YEM-H4853</p>  <p>SK-8保险盒</p>	
<p>YEM-H4854</p>  <p>DH-7微动开关</p>	<p>YEM-H4855</p>  <p>SK微动开关</p>	<p>YEM-H4856</p>  <p>DH新款微动开关</p>	<p>YEM-H4857</p>  <p>DH-5微动开关</p>	
<p>YEM-H4858</p>  <p>DH60/R60微动开关</p>	<p>YEM-H4859</p>  <p>VOLVO微动开关</p>	<p>YEM-H4860</p>  <p>PC微动开关</p>	<p>YEM-H4861</p>  <p>VOLVO微动开关</p>	

电器件 ELECTRIC PARTS

 <p>现代微动开关</p>	 <p>三一微动开关</p>	 <p>E320B时间继电器 Starter Relay</p>	 <p>320C时间继电器 Starter Relay</p>
 <p>大字雨刮继电器 2537-9008 RELAY</p>	 <p>大字直流电转换器 2531-1003 RELAY</p>	 <p>大字雨刮计时器 2543-9015 RELAY</p>	 <p>三菱继电器 MITSUBISHI ME077148 RELAY</p>
 <p>继电器(100A) MZJ-100A RELAY</p>	 <p>继电器(200A) MZJ-200A RELAY</p>	 <p>继电器(400A) MZJ-400A RELAY</p>	 <p>继电器(600A) MZJ-600A RELAY</p>
 <p>洋马继电器 YANMAR HC0119 RELAY</p>	 <p>洋马继电器 YANMAR HC0108 RELAY</p>	 <p>康明斯启动继电器 CUMMINS 3916302 RELAY</p>	 <p>柳工徐工玉柴龙工厦工 12V继电器</p>
 <p>预热继电器(4插) 12V RELAY</p>	 <p>VOLVO继电器 VOLVO RELAY</p>	 <p>V0V继电器</p>	 <p>日立继电器 EX200-2/3/5 4251588 RELAY</p>
 <p>继电器(6插) 12V/24V RELAY</p>	 <p>小松空调继电器 PC200-8 7861-74-5100 RELAY</p>	 <p>继电器(小5插) 12V/24V RELAY</p>	 <p>继电器(小4插) 12V/24V RELAY</p>
 <p>绿色继电器 RELAY</p>			

电器件 ELECTRIC PARTS

 <p>R-7时间继电器 RELAY</p>	 <p>R-7雨刮继电器 RELAY</p>	 <p>洋马继电器 RELAY</p>	 <p>洋马继电器 RELAY</p>	 <p>五十铃继电器 RELAY</p>
 <p>沃尔沃 EC210/240/290/360 预热继电器</p>	 <p>6D108/6D125 SOL专用</p>	 <p>小松马达新款继电器</p>	 <p>PC200/EX200 600-815-8941 方继电器 Relay</p>	 <p>4JJ1/4HK1/6BG1 /6SD1/6WG1 马达继电器 Relay 1-82553039-1</p>
 <p>PC200-7马达继电器 Relay 600-815-2170/600-815-8940</p>	 <p>启动马达继电器 Relay</p>	 <p>三菱/神钢/卡特 安全启动继电器</p>	 <p>4HK1/6HK1安全启动继电器</p>	 <p>神钢-8电源开关 SK200-8 RELAY</p>
 <p>单脚电源开关 RELAY</p>	 <p>双脚电源开关 RELAY</p>	 <p>电源开关(带胶正极) BR263 08088-30000 RELAY</p>	 <p>电源开关(负极) BR266 RELAY</p>	 <p>ZAX通用电源总开关</p>
 <p>柳工电源开关</p>	 <p>卡特预热继电器</p>	 <p>CAT398-0940 卡特预热发电机</p>	 <p>卡特D型继电器</p>	 <p>神钢J05/J08 安全启动继电器</p>
 <p>JO5/J08预热继电器</p>	 <p>沃尔沃210-360预热继电器</p>	 <p>卡特继电器黑线</p>	 <p>卡特继电器黄线</p>	 <p>A:小松HT20-2 D60 B:PC200-3/5 发电机调节器 GENERATOR ADJUSTER</p>

全车线束 WHOLE CAR WIRING HARNESS

全车线束 WHOLE CAR WIRING HARNESS

YEM-H4917



PC200-6 外线速
20Y-06-22713

YEM-H4918



PC200-7外线
20Y-06-31611

YEM-H4919



PC200-6 6D102内线

YEM-H4920



PC200-7老款内线
20Y-06-31110

YEM-H4921



PC200-7老款外线
20Y-06-31611

YEM-H4922



PC200-7新款外线
20Y-06-31614 31612

YEM-H4923



PC200-8主线
20Y-06-42411

YEM-H4924



PC300-6内线

YEM-H4925



PC300-7新款内线
207-06-71562

YEM-H4926



PC300-7新款外线
207-06-71114

YEM-H4927



小松PC-8发动机线
6754-81-9440

YEM-H4928



小松线207-06-71170

YEM-H4929



PC200-7显示屏线束

YEM-H4930



PC400-7发动机线

YEM-H4931



EX200-3全车线

YEM-H4932



日立6HK1发动机线
1-82641375-7

YEM-H4933



日立4HK1发动机线
8-98002897-7

YEM-H4934



EX200-5
pump harness液压泵线

YEM-H4935



ZAX-1
液压泵线束4449447

YEM-H4936



ZAX-3
内线0007745

YEM-H4937



ZAX-3内线0006003

YEM-H4938



ZAX-3液压泵线束

YEM-H4939



液压泵线束
CAT320D2

YEM-H4940



液压泵线束
CAT320D

YEM-H4941



液压泵线束
CAT320C

YEM-H4942



ZAX200-1内线

YEM-H4943



ZAX200-1
外线0003323

YEM-H4944



ZAX470-3
外线 0005997H

YEM-H4945



DH225-7发动机线束

YEM-H4946



发动机线束J08

YEM-H4947



卡特C9发动机线束

YEM-H4948



DH225-7主线束

YEM-H4949



大宇225-7线束

YEM-H4950



大宇225-7线束



YEM-H4951



大宇225-7线束







全车线束 WHOLE CAR WIRING HARNESS

全车线束 WHOLE CAR WIRING HARNESS































<p>YEM-H4952</p>  <p>卡特C7油嘴线束</p>	<p>YEM-H4953</p>  <p>卡特C9油嘴线束</p>	<p>YEM-H4954</p>  <p>大字225-7线束</p>	<p>YEM-H4955</p>  <p>大字225-7线束</p>
<p>YEM-H4956</p>  <p>大字225-7线束</p>	<p>YEM-H4957</p>  <p>大字225-7线束</p>	<p>YEM-H4958</p>  <p>大字225-7线束</p>	<p>YEM-H4959</p>  <p>大字225-7全车线</p>
<p>YEM-H4960</p>  <p>2530-1608 大字220-5发动机线束</p>	<p>YEM-H4961</p>  <p>DH225-7显示屏线束</p>	<p>YEM-H4962</p>  <p>VOLVO380线</p>	<p>YEM-H4963</p>  <p>VOLVO 14631808</p>
<p>YEM-H4964</p>  <p>320D发动机线296-4617</p>	<p>YEM-H4965</p>  <p>卡特发动机线</p>	<p>YEM-H4966</p>  <p>卡特E320D显示屏线束</p>	<p>YEM-H4967</p>  <p>PC200-8 喷油嘴线束</p>
<p>YEM-H4968</p>  <p>PC400-7喷油嘴线束</p>	<p>YEM-H4969</p>  <p>住友4HK1发动机线 8-97362843-7</p>	<p>YEM-H4970</p>  <p>三菱6D34发动机线</p>	<p>YEM-H4971</p>  <p>J05E发动机线</p>

<p>YEM-H4972</p>  <p>J08E发动机线</p>	<p>YEM-H4973</p>  <p>SK-8保险丝盒电线 LC13E01186P1</p>	<p>YEM-H4974</p>  <p>SK-8发动机线 YN13E01533P2</p>	<p>YEM-H4975</p>  <p>SK200-2-5外线</p>
<p>YEM-H4976</p>  <p>SK200-2内线</p>	<p>YEM-H4977</p>  <p>SK200-5内线</p>	<p>YEM-H4978</p>  <p>SK200-6外线</p>	<p>YEM-H4979</p>  <p>SK230-6E外线</p>
<p>YEM-H4980</p>  <p>sk330-6E main harness</p>	<p>YEM-H4981</p>  <p>VH82121E0G60 发动机线 SK-8</p>	<p>YEM-H4982</p>  <p>YN13E01446P9 SK200-8发动机线速</p>	<p>YEM-H4983</p>  <p>YN13E01525P3 P4 SK-8电线</p>
<p>YEM-H4984</p>  <p>YN14E01111P2 SK-8显示屏线接电脑</p>	<p>YEM-H4985</p>  <p>神钢-8电线(低压传感器) YN13E01531P3</p>	<p>YEM-H4986</p>  <p>VH820649530A 1</p>	<p>YEM-H4987</p>  <p>VH820649530A</p>
<p>YEM-H4988</p>  <p>VH820649540A.1</p>	<p>YEM-H4989</p>  <p>VH820649540A</p>	<p>YEM-H4990</p>  <p>YN13E01444P2</p>	<p>YEM-H4991</p>  <p>VH820306412A</p>

插头系列 HARNESS SERIES

 YEM-H4992 PC二极管 22U-06-22420 DIODE	 YEM-H4993 大宇二极管	 YEM-H4994 PC200-7电脑板插头	 YEM-H4995 PC200-7显示屏插头	 YEM-H4996 PC200-8电脑板插头
 YEM-H4997 PC200-8显示屏插头	 YEM-H4998 E320D电脑板插头	 YEM-H4999 E320C油门马达插头	 YEM-H5000 卡特传感器灰色二线插头	 YEM-H5001 卡特传感器灰色三线插头
 YEM-H5002 卡特喷嘴插头	 YEM-H5003 卡特传感器黄色二线插头	 YEM-H5004 卡特传感器红色三线插头	 YEM-H5005 卡特机油传感器接头	 YEM-H5006 沃尔沃显示屏插头
 YEM-H5007 沃尔沃显示屏母插	 YEM-H5008 沃尔沃显示屏公插	 YEM-H5009 VOLVO电脑板插头	 YEM-H5010 大宇油门小板插头	 YEM-H5011 DH225-7显示屏插头
 YEM-H5012 三菱柴油泵 6D16插头	 YEM-H5013 SK-6转SK-8转换插头	 YEM-H5014 三一油门旋钮插头	 YEM-H5015 住友油门马达插头	 YEM-H5016 神钢曲轴传感器插头
 YEM-H5017 SK200-6E高压插头	 YEM-H5018 PC200-8高压共轨传感器插头	 YEM-H5019 小松/卡特传感器插头(小方插)	 YEM-H5020 ZAX电喷水温传感器	 YEM-H5021 ZAX电喷机油传感器插头

插头系列 HARNESS SERIES

 YEM-H5022 三一传感器插头	 YEM-H5023 三一 高低压传感器	 YEM-H5024 神钢电磁阀插头	 YEM-H5025 神钢电磁阀插头	 YEM-H5026 日立电磁阀插头
 YEM-H5027 日立 电磁阀	 YEM-H5028 小松压力开关插头	 YEM-H5029 小松压力开关插头	 YEM-H5030 4436535/536压力开关插头	 YEM-H5031 日立/大宇压力开关插头
 YEM-H5032 日立定位器插头	 YEM-H5033 PC200-7/卡特大方插	 YEM-H5034 日立 SCU阀	 YEM-H5035 小松油门马达三线插头	 YEM-H5036 小松油门马达四线插头
 YEM-H5037 小松PC200-7 油门马达三线插头	 YEM-H5038 小松PC200-7 油门马达四线插头	 YEM-H5039 日立油门马达三线插头	 YEM-H5040 日立油门马达四线插头	 YEM-H5041 卡特油门马达六线插头
 YEM-H5042 神钢油门马达三线插头	 YEM-H5043 神钢油门马达四线插头	 YEM-H5044 加藤油门马达六线插头	 YEM-H5045 SK200-8转SK200-6E 传感器插头	 YEM-H5046 神钢 住友 传感器插头
 YEM-H5047 神钢 住友 传感器插头	 YEM-H5048 SK200-8转SK200-6 传感器插头	 YEM-H5049 SK200-8高压传感器插头 4436271	 YEM-H5050 SK200-8凸轮轴传感器插头	 YEM-H5051 SK200-6E转SK200-6 传感器插头

驾驶室 CAB

YEM-H5052



驾驶室 Cab
E200B DSC01855

YEM-H5053



驾驶室 Cab
E320B

YEM-H5054



驾驶室 Cab
E320C

YEM-H5055



驾驶室 Cab
E320D 4567858

YEM-H5056



驾驶室 Cab
E320D 驾

YEM-H5057



驾驶室 Cab
E320D 高仿驾

驾驶室 CAB

YEM-H5058



驾驶室 Cab
PC60-7E330D

YEM-H5059



驾驶室 Cab
EX200-2

YEM-H5060



驾驶室 Cab
EX-5

YEM-H5061



驾驶室 Cab
EX200-5

YEM-H5062



驾驶室 Cab
PC200-5

YEM-H5063



驾驶室 Cab
PC60-7

YEM-H5064



驾驶室 Cab
山推PC200-7驾

YEM-H5065



驾驶室 Cab
SH120-3

YEM-H5066



驾驶室 Cab
SK120-5驾(飞机头)

YEM-H5073



驾驶室 Cab
ZX200-3(电)新锁驾

YEM-H5074



驾驶室 Cab
ZAX200-3电喷 DSC01529

YEM-H5075



驾驶室 Cab
ZAXIS110

YEM-H5067



驾驶室 Cab
SK135RS驾

YEM-H5068



驾驶室 Cab
SK200-6E驾

YEM-H5069



驾驶室 Cab
SK200-8驾驶室

YEM-H5076



驾驶室 Cab
三一215-8

YEM-H5077



驾驶室 Cab
三一215-8

YEM-H5078



驾驶室 Cab
HD820-3

YEM-H5070



驾驶室 Cab
SH200A2 驾

YEM-H5071



驾驶室 Cab
SH200A3 驾(5)

YEM-H5072



驾驶室 Cab
SH430驾(12)

YEM-H5079



驾驶室 Cab
DH220-5

YEM-H5080



驾驶室 Cab
沃尔沃210B

YEM-H5081



座椅

外罩系列 COVER SERIES

<p>YEM-H5082</p>  <p>ZX200-6驾驶室</p>	<p>YEM-H5083</p>  <p>VOLVO210驾驶室</p>	<p>YEM-H5084</p>  <p>CAT336D驾驶室</p>	<p>YEM-H5085</p>  <p>PC200-7驾驶室</p>	
<p>YEM-H5086</p>  <p>E320C驾驶门</p>	<p>YEM-H5087</p>  <p>PC200-7驾驶门</p>	<p>YEM-H5088</p>  <p>SK250-8驾驶门</p>	<p>YEM-H5089</p>  <p>ZA-6驾驶门</p>	
<p>YEM-H5090</p>  <p>保险杠</p>	<p>YEM-H5091</p>  <p>SK350-8水箱门</p>	<p>YEM-H5092</p>  <p>E323D水箱边门</p>	<p>YEM-H5093</p>  <p>ZX330-3G水箱边门</p>	<p>YEM-H5094</p>  <p>PC400-6护罩</p>
<p>YEM-H5095</p>  <p>PC200-8工具箱</p>	<p>YEM-H5096</p>  <p>E330D工具箱</p>	<p>YEM-H5097</p>  <p>CAT卡特D型老款座椅</p>	<p>YEM-H5098</p>  <p>PC200-7座椅</p>	<p>YEM-H5099</p>  <p>国产通用型护网</p>
<p>YEM-H5100</p>  <p>徐工60机罩</p>	<p>YEM-H5101</p>  <p>PC60-7机罩</p>	<p>YEM-H5102</p>  <p>柳工906C机罩</p>	<p>YEM-H5103</p>  <p>柳工907/908后盖</p>	

外罩系列 COVER SERIES

<p>YEM-H5104</p>  <p>沃尔沃55机罩</p>	<p>YEM-H5105</p>  <p>临工60机罩</p>	<p>YEM-H5106</p>  <p>现代80-7</p>	<p>YEM-H5107</p>  <p>沃尔沃55D</p>
<p>YEM-H5108</p>  <p>雷沃65-7</p>	<p>YEM-H5109</p>  <p>SK60C后盖</p>	<p>YEM-H5110</p>  <p>DX80后盖</p>	<p>YEM-H5111</p>  <p>E308新</p>
<p>YEM-H5112</p>  <p>PC60-7油箱罩</p>	<p>YEM-H5113</p>  <p>柳工907/908油箱罩</p>	<p>YEM-H5114</p>  <p>E320BU柴油箱外罩</p>	<p>YEM-H5115</p>  <p>PC75柴油箱外罩</p>
<p>YEM-H5116</p>  <p>SK120-5柴油箱罩</p>	<p>YEM-H5117</p>  <p>现代80-7工具箱</p>	<p>YEM-H5118</p>  <p>VOLVO210工具箱</p>	<p>YEM-H5119</p>  <p>神钢135油箱罩</p>
<p>YEM-H5120</p>  <p>沃尔沃240新款</p>	<p>YEM-H5121</p>  <p>沃尔沃350D</p>	<p>YEM-H5122</p>  <p>沃尔沃D系列新款/挖机驾驶室顶盖</p>	<p>YEM-H5123</p>  <p>PC40-1顶棚</p>

玻璃/天窗 GLASS,SKYLIGHTS

玻璃门框 EXCAVATOR GLASS

YEM-H5124



玻璃 Glass
PC-8

YEM-H5125



玻璃 Glass
EX-8

YEM-H5126



玻璃 Glass
EX-5 新

YEM-H5127



玻璃 Glass
EX-6

YEM-H5128



玻璃 Glass
CAT320C

YEM-H5129



玻璃 Glass
CAT305

YEM-H5130



玻璃 Glass
VOLOV210

YEM-H5131



玻璃 Glass
SK-7

YEM-H5132



玻璃 Glass
DH-7

YEM-H5133



玻璃 Glass
R-7

YEM-H5134



玻璃 Glass
HD820

YEM-H5135



玻璃 Glass
其它

YEM-H5136



SK-1天窗玻璃

YEM-H5137



SK-3天窗玻璃

YEM-H5138



SK-5天窗玻璃

YEM-H5139



SK-6天窗玻璃

YEM-H5140



PC200-6前档

YEM-H5141



PC200-5前档

YEM-H5142



PC200-6左门框

YEM-H5143



PC200-5左门框

YEM-H5144



PC200-7左门框

YEM-H5145



E320左门框

YEM-H5146



SH280

YEM-H5147



EX200-2下档

YEM-H5148



EX200-2/3左门框

YEM-H5149



EX200-2/3右门框

YEM-H5150



EX200-6左门框

YEM-H5151



E200-5左门框

YEM-H5152



PC200-5下档

YEM-H5153



PC200-5右门框

YEM-H5154



PC200-6右门框



卡特312B扶手箱



卡特320C喇叭罩米黄色



卡特320C新款喇叭罩



卡特320C左右立柱



卡特320D内饰



卡特320D内饰



卡特320D内饰



卡特320D内饰



卡特320D内饰



卡特320D先导线管套



卡特320D新款喇叭罩



卡特灯罩



斗山-7-9驾驶室天花, 毛粘板



斗山-7内饰板



斗山55扶手箱装饰板



斗山55推土机盖



斗山60-7左边扶手箱



斗山60-7右边扶手箱



斗山60-7内饰件



斗山DX60扶手箱



斗山DX260内饰



斗山DX扶手箱



斗山DX门锁盖板



斗山内饰橡胶件

YEM-H5179



日立70扶手箱

YEM-H5180



日立70全车内饰

YEM-H5181



日立ZAX-6喇叭网

YEM-H5191



小松-8回转开关

YEM-H5192



小松-8喇叭网

YEM-H5193



小松-8全车内饰

YEM-H5182



ZAX200-6全车内饰

YEM-H5183



ZAX200-6直喷顶棚

YEM-H5184



ZAX日立200-3电喷顶棚

YEM-H5194



小松-8仪表侧板

YEM-H5195



小松60-7操纵杆扶手箱

YEM-H5196



小松60-7新款工具箱

YEM-H5185



ZAX-6烟灰缸

YEM-H5186



小松-6内饰件

YEM-H5187



小松-7前档锁

YEM-H5197



小松200-7顶棚

YEM-H5198



小松200-7工具箱

YEM-H5199



小松200-7空滤小门

YEM-H5188



小松-7新款内饰

YEM-H5189



小松-7新款仪表侧板

YEM-H5190



小松-8扶手箱

YEM-H5200



小松200-7仪表面盖

YEM-H5201



小松200-8顶棚

YEM-H5202



小松200-8工具箱



YEM-H5203
小松200-8外空滤小门



YEM-H5204
现代-7新款工具箱



YEM-H5205
现代-7新款全车内饰



YEM-H5215
住友200A3全车内饰全图



YEM-H5216
住友210-5右边装饰板



YEM-H5217
住友210-5左边装饰板



YEM-H5206
现代-9扶手箱9



YEM-H5207
现代60-7, 福田60扶手箱



YEM-H5208
现代60-7内饰

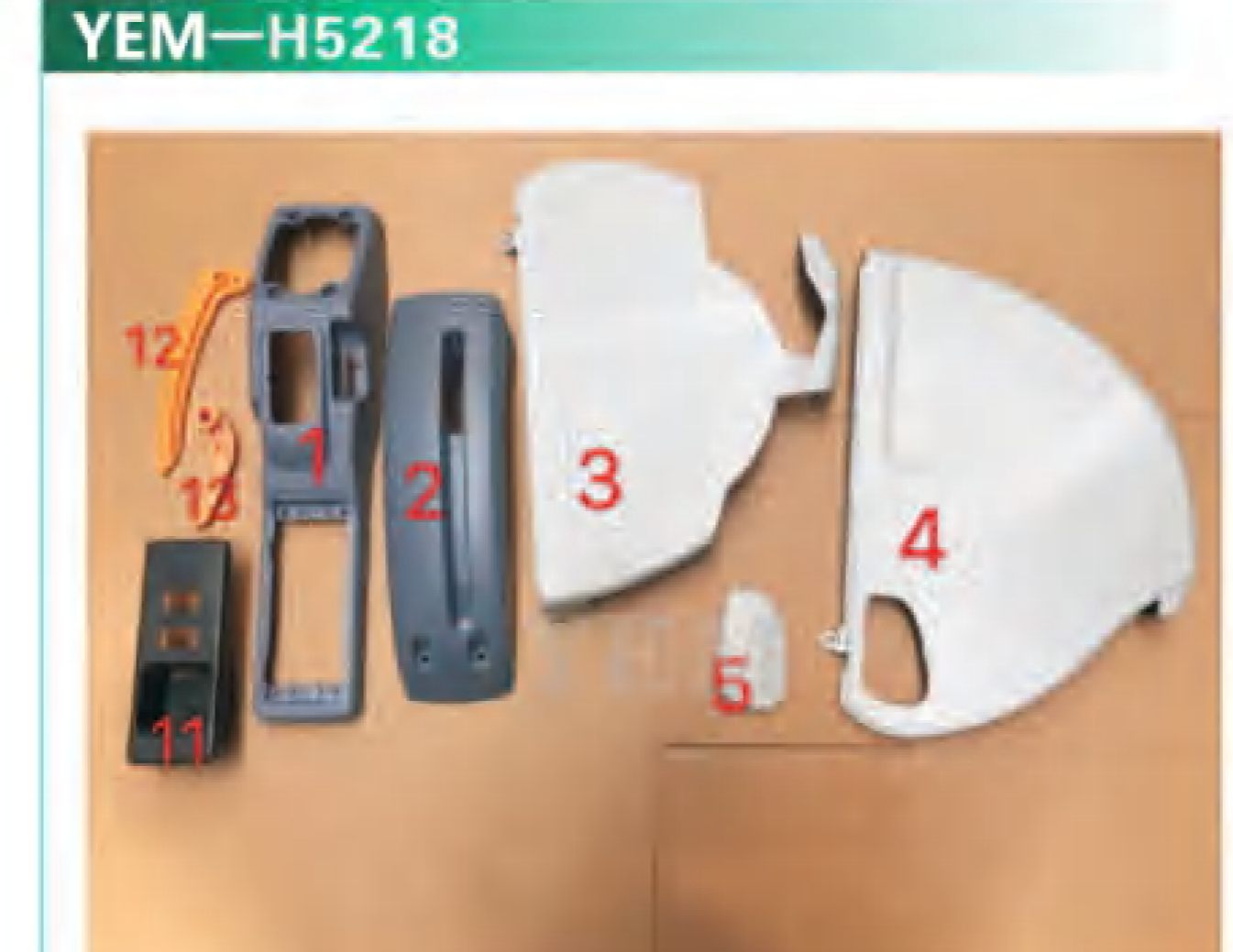

YEM-H5218
住友A3操纵杆装饰板



YEM-H5219
住友A3操纵杆装饰板



YEM-H5220
住友A5驾驶室门外金标



YEM-H5209
现代215-7操作杆装饰板右边



YEM-H5210
现代215-7操作杆内饰板左边



YEM-H5211
现代215-7扶手箱右边



YEM-H5221
住友A5喇叭网



YEM-H5222
住友A5全车内饰



YEM-H5223
住友A5上盖小开关



YEM-H5212
现代215-7老款扶手箱左边



YEM-H5213
住友-5操作杆左右上盖小贴



YEM-H5214
住友200A1A2操纵杆装饰板



YEM-H5224
住友A5脚踏



YEM-H5225
徐工扶手箱



YEM-H5226
徐工扶手箱



山东临工60扶手箱



山东临工665扶手箱



沃尔沃210B新款脚踏皮



沃尔沃210B仪表外壳



沃尔沃480D扶手箱



沃尔沃480D内饰



沃尔沃出风口



沃尔沃新款老款喇叭网

沃尔沃喇叭



沃尔沃前顶托



沃尔沃新款喇叭网



沃尔沃烟灰缸



沃尔沃左右休息总成



沃尔沃210B操作杆装饰板



沃尔沃210B全车内饰



神钢-8工具箱



神钢超8内饰



神钢超8内饰



神钢-6E工具箱



空调出风口



空调出风口



神钢-6天窗扣



神钢-6E操作杆右上盖



神钢-6E右边右侧板



神钢-6E左上盖



神钢杠8超左右内饰



神钢-6E右边左侧板



神钢-6E左边右侧板



神钢-6E左边左侧板



厦工工具箱



福田60-7新款扶手箱



福田60老款扶手箱



力士德, 常林工具箱



三一-65 75-8扶手箱



三一-65-9扶手箱



三一-215-9扶手箱



三一-215-8扶手箱



三一-8内饰件



凯斯210B右扶手箱



凯斯210B左扶手箱



福田150-7扶手箱

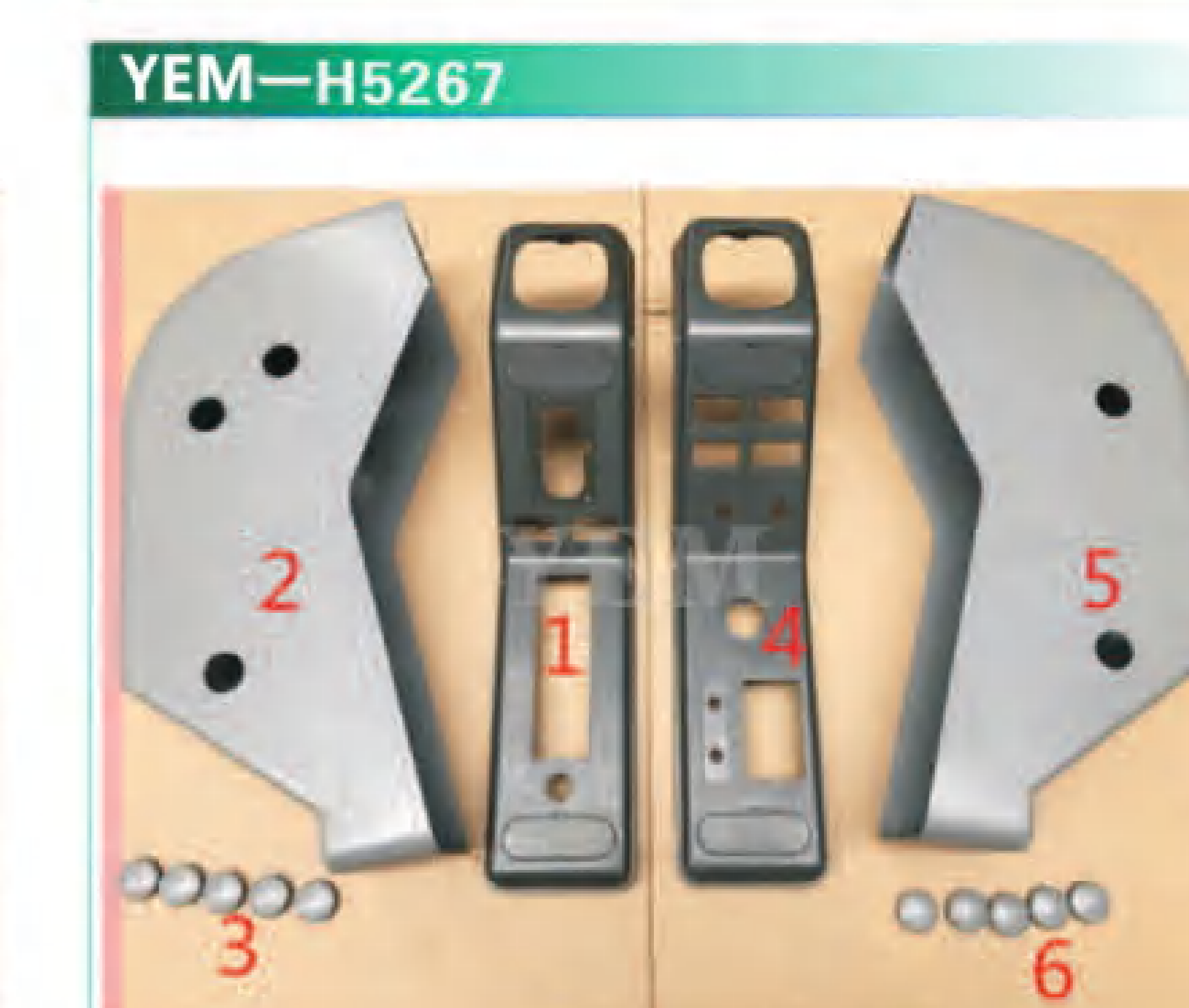

福田220-7扶手箱_3



柳工205C工具箱



柳工915 920 922 925 936扶手箱



柳工922D工具箱

YEM-H5271



PC200-5坑手胶壳

YEM-H5272



PC200-6工具箱

YEM-H5273



PC200-6
驾驶室左边内饰板

YEM-H5286



边门 PC200-8

YEM-H5287



左右边门 PC220-8

YEM-H5288



机罩 PC120-6

YEM-H5274



PC200-6 HD820
坑手胶壳

YEM-H5275



PC120-6 200-6
空调控制面板

YEM-H5276



CAT320
工具箱坑手胶壳

YEM-H5289



机罩 PC350-7

YEM-H5290



PC200-7

YEM-H5291



机罩 PC60-7

YEM-H5277



CAT320
驾驶室前饰板 仪表座胶壳

YEM-H5278



CAT320B
坑手胶壳及内饰板

YEM-H5279



CAT320内饰板

YEM-H5292



引擎罩 PC450-7

YEM-H5293



水箱边门 ZX120-6

YEM-H5294



水箱边门 ZX360H-3G

YEM-H5280



CAT320 长短出风口

YEM-H5281



CAT320内饰胶壳

YEM-H5282



EX120-5坑手胶壳

YEM-H5295



液压边门 ZA360H-3G

YEM-H5296



液压边门 ZA240-3

YEM-H5297



电喷空滤边门 ZA360-3

YEM-H5283



日立120-5边盖

YEM-H5284



日立120-5工具箱

YEM-H5285



SH280坑手胶壳

YEM-H5298



ZA200-6

YEM-H5299



散热器边门 ZAX120-6

YEM-H5300



液压边门 ZAX200-3G

边门机盖系列 SIDE DOOR COVER SERIES

边门机盖系列 SIDE DOOR COVER SERIES

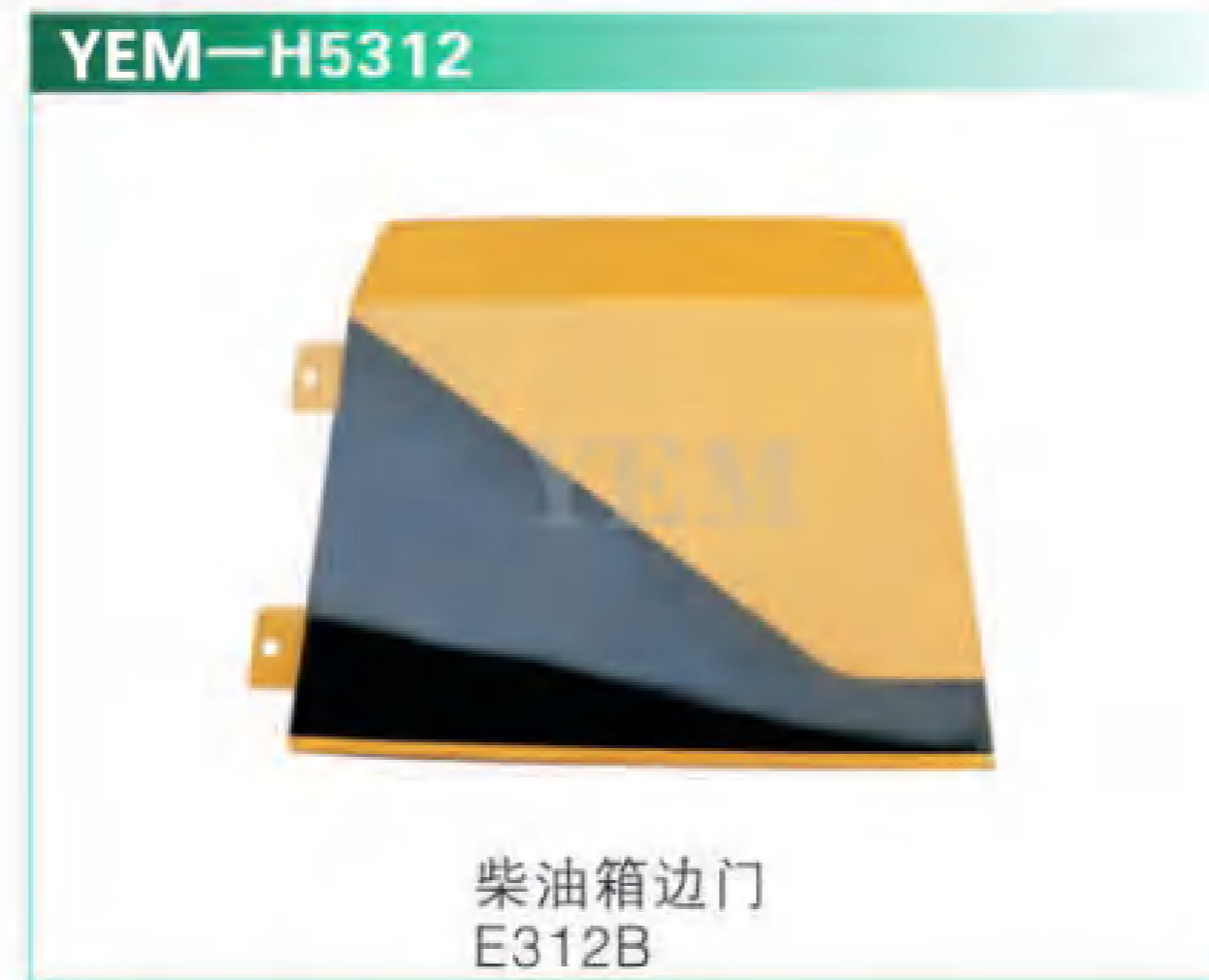
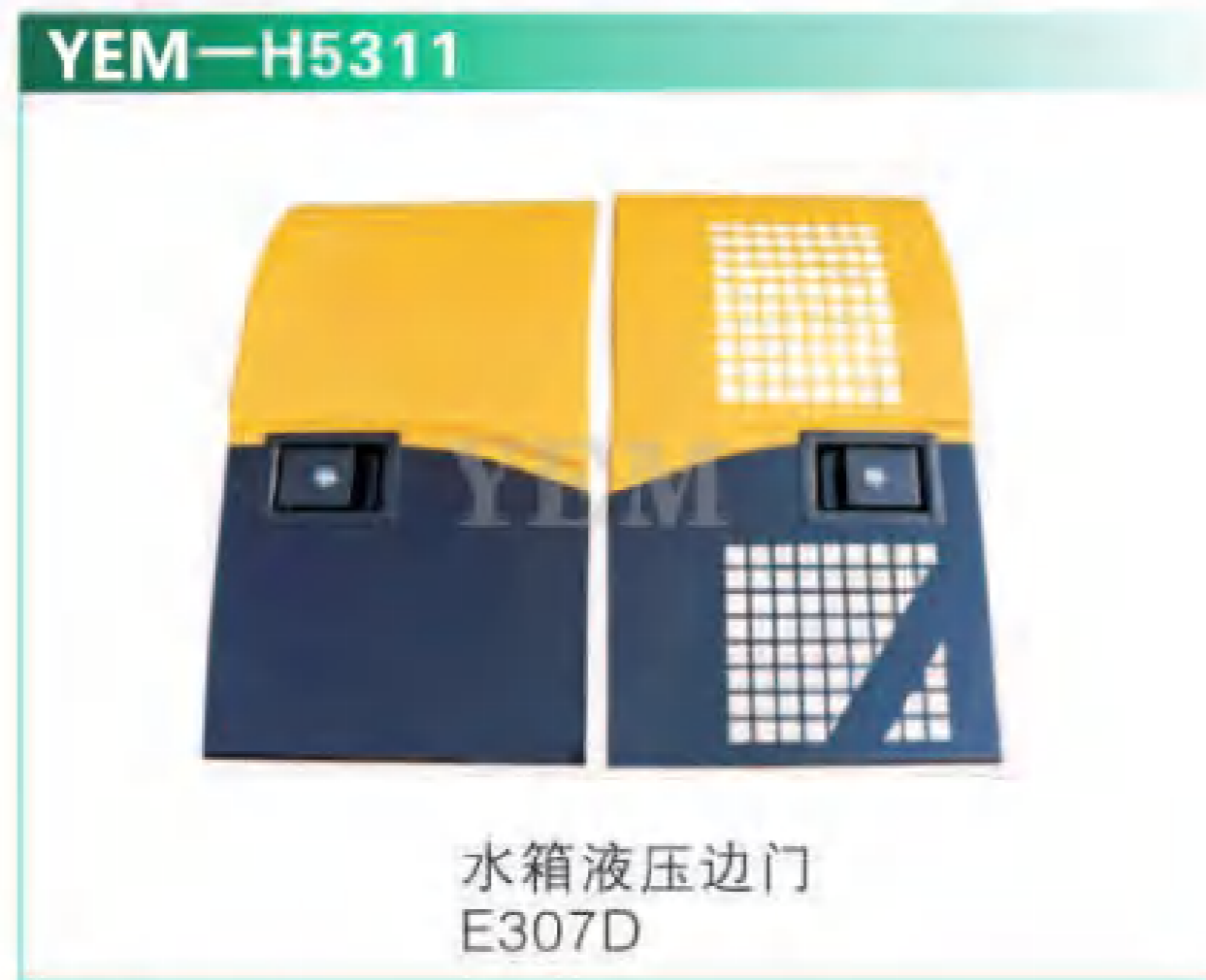

- | | | | | |
|--|---|--|--|---|
| SK230-6E机罩
SK230-6机罩
SK120-6机罩
SK200-8机罩
SK60-8机罩
SK60-5机罩
SK200-8工具箱
SK350-8机罩
SK200-5引擎罩
SK200-6机罩
SK330-6E机罩
SK200-5机罩 | CAT320D机罩
CAT307B机罩
CAT330C机罩
CAT320C机罩
CAT330D水箱罩
CAT330A机罩
CAT312B机罩
CAT308B护罩
CAT330机罩
CAT320机罩 | PC200-8工具箱
PC200-7机罩
PC60-7玻璃钢
PC60-7油箱盖护罩
PC120-6机罩
PC78US-5护罩/罩盖
PC78US-5侧板(3个)
PC450-7机罩
PC200-7机头罩
PC200-6机头罩
PC75UU-3罩盖
PC60-7机罩 | ZAX240-3机罩
ZAX240-3G机罩
EX360-6引擎罩
EX120-2机罩
ZAX200-1机罩
EX200-5机罩
SH120A2机罩
SH200A2机罩
SH200-5机罩
三一225-7机罩
KATO820-3机罩 | SK350-8边门
SK200-8边门
SK200-5水箱边门
SK200-6E液压边门
CAT320C液压边门
CAT120B液压边门
CAT320C水箱边门
CAT320C边门
CAT320C边门
ZAX240-3液压边门
ZAX330-3G水箱边门
ZAX330-3G液压边门
ZAX360-3边门
ZAX200-1边门
PC200-8边门
PC200-7边门
HD700边门 |
|--|---|--|--|---|

油封 Seal Kit

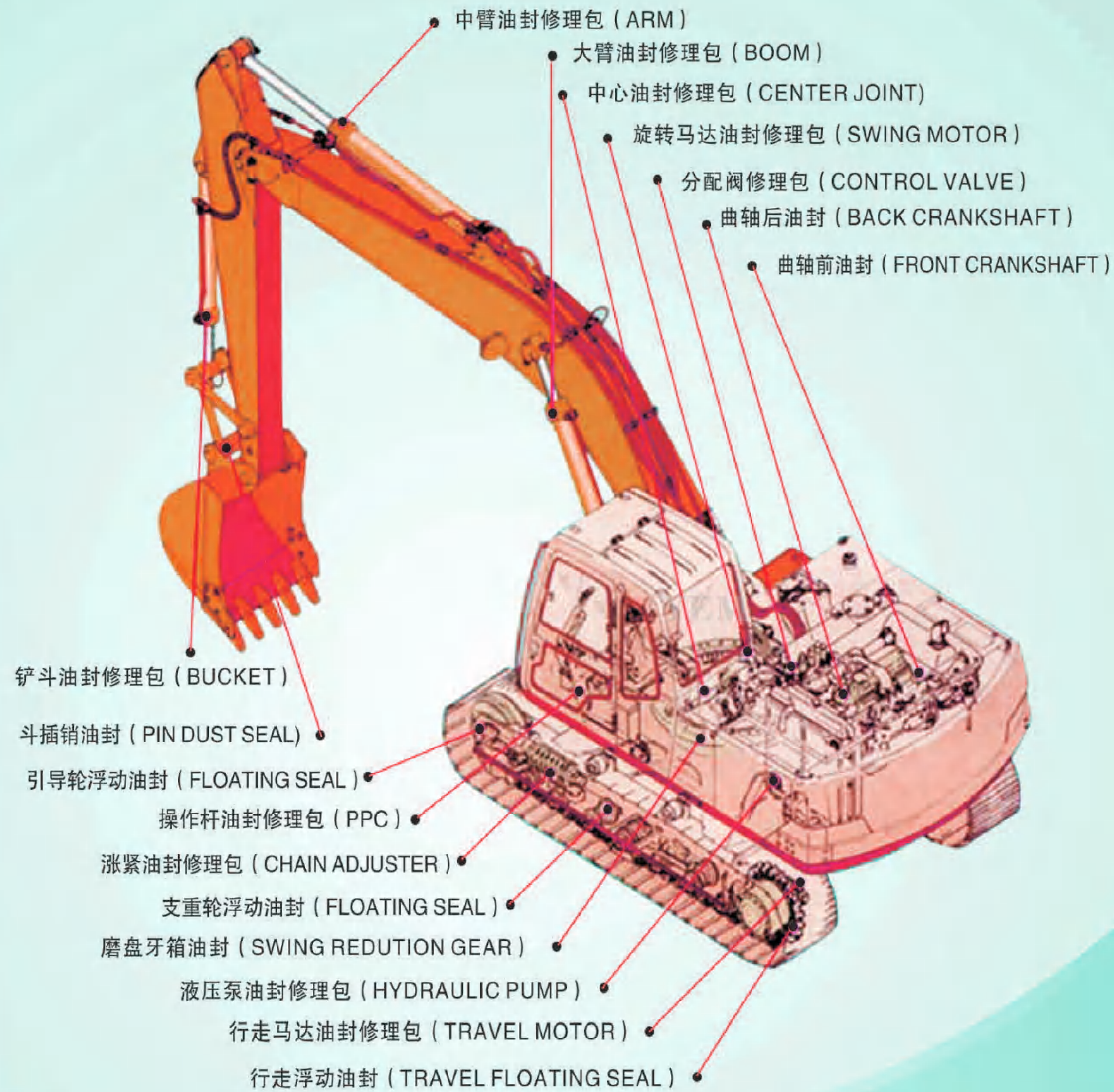

专业经营各种进口油封修理包

YEM-H5325



油缸修理包

YEM-H5326



HALLITE油封

YEM-H5327



NOK骨架油封曲前曲后系列

YEM-H5328



NOK破碎锤油封系列

YEM-H5330



涨紧油缸系列
Oil Seal

YEM-H5332



操纵杆修理包
Lever Valve

YEM-H5334



行走马达油封
Travelling Motor Oil Seal

YEM-H5336



分配阀修理包
Control Valve Seal Kit

YEM-H5329



DKB防尘油封 Oil Seal

YEM-H5331



打链拍油封
Oil Seal

YEM-H5333



分油中修理包
Center Jiont Kit

YEM-H5335



齿轮泵修理包
Punp Valve Seal Kit

YEM-H5337



提升器修理包
Pumpplunge Seal Kit

YEM-H5338



主阀修理包
Oil Seal

YEM-H5339



WR木柏系列
Oil Seal

YEM-H5340



回转泵修理包
Swing motor seal Kit

YEM-H5341



大臂油缸修理包
Boom Cyl Kit

YEM-H5342



中臂油缸修理包
Arm Cyl Kit

YEM-H5343



斗臂油缸修理包
Bucket Cyl Kit

YEM-H5344



ITEM:DKB-WIPERSEAL

YEM-H5345



ITEM:NOK-IDI-USEAL

YEM-H5346



ITEM:IDI-SJ

YEM-H5347



ITEM:NOK-IUH

YEM-H5348



ITEM:HBY

YEM-H5349



ITEM:HBY-SJ

YEM—H5350



发动机曲轴前后油封对照表 ENGINE CRANKSHAFT SEAL F/R COMPARISON TABLE

品牌 BRAND	发动机型号 ENGINE MODEL	名称 DESCRIPTION	油封编码 SEAL CODE	尺寸 SIZE	
DAEWOO	DB58T	曲前 Front	AH3222	60x82x12	
	DB58T	曲后 Bcak	AZ4079	100x135x15	
	DB58T	曲后 Bcak	BH3732E		
HINO	EL100	曲前 Front	AE3618	75x100x13	
	EL100	曲后 Bcak	BH1566		
	H07CT/H06CT	曲前 Front	AH3400P	65x88x12	
	H07CT/H06CT	曲后 Bcak	AH7425Q		
MITSUBISHI	6D14	曲前 Front	AE7228E		
	6D14-O	曲后 Bcak	AH7472		
	6D14新	曲前 Front	BE4018		
	6D16-N	曲后 Bcak	BZ2374		
	6D16-N	曲前 Front	BZ4526		
	6D22	曲后 Bcak	AZ8854		
	6D22	曲前 Front	BZ1335	25x45x8	
	6D31	曲后 Bcak	BH3258		
	6D31/4D31	曲前 Front	AE3055	55x78x12	
	6D31-O	曲前 Front	AE3053	55x78x9	
	6D31-O	曲后 Bcak	AH8307P		
	6D34	曲后 Bcak	BZ4603		
	6D34	曲前 Front	BZ5051		
	S4F	曲前 Front	AE3055	55x78x12	
	S4F	曲后 Bcak	AH3932	90x115x13	
	S6KT/3066	曲前 Front	AE3527	70x95x13	
	S6KT-N	曲后 Bcak	AZ4291		
	S6KT-O	曲后 Bcak	BH3673E		
	ISUZU	4BD1	曲后 Bcak	BH2195	
		4BD1带铁	曲后 Bcak	AH4079	
		4JB1	曲前 Front	AE2847	50x68x9
4JB1		曲后 Bcak	AH8846		
6BD1/6BG1		曲前 Front	AH3222	60x82x12	
6BD1/6BG1		曲后 Bcak	AH7079R		
KOMATSU	6BD1/6BG1	曲后 Bcak	BH3732E	80x100x10	
	6D105	曲前 Front	AH3409	65x90x13	
	6D105	曲后 Bcak	AH8279		
	6D108	曲前 Front	AE3409	65x90x13	
	6D108	曲前 Front	AE3409P		
	6D108	曲后 Bcak	AW4395		
	6D108	曲后 Bcak	AW4915		
	6D125	曲前 Front	AE3963		
	6D125	曲后 Bcak	BW2410		
	6D95	曲前 Front	AH3297	62x85x12	
6D95	曲后 Bcak	AW9063			

回转骨架油封通用表

型号	规格	通用机型
AD3842I	85-110-13	PC60-5/6
AA4390	125-140-4	PC60-7(大)
AD4581A	145-175-14	PC100-6 PC120-6
AP4063B	100-125-13	HD700-5/7 SH200 LS2800FJ DH820
AD4063E	100-125-13	HD800-5/7 R210 DH220 PC100-5 PC120-5
AP4346B	120-150-14	PC200-1/2 PC220-1/2 HD1250 20HT-3 HD1430
AD4346A	120-150-14	HD900
AD4399E	125-155-14	PC220-3/5/6(小机头) PC200-3/5/6
AP4399E	125-155-14	SH220-3
BW0760E	125-155-18	PC200-6/6D102
AD4451A	130-160-14	PC300-3 PC400-3 HD770SE HD770-1
AD4542A	140-170-14	PC300-5/6 E300
AE4624E	150-180-14	PC400-3/5/6 HD880SE HD850G UH07-7
BW5602E	150-180-18	PC400-6(高机号+)
BW4528E	160-195-21	EX100-2 EX120-2/3/5
BA4023E	230-260-16/18	EX200-1
BW4526H	190-225-22	EX200-2/3/5 EX220-1/2/3/5
BW4527G	232-267-21	EX220-5
BW5856	252-287-21	EX300-5
AA5019	195-225-15/18	EX400
AA7297	140-210-18/31	EX160WD
AD5562E	280-320-22	EX330
AD5205G	220-250-16	ZAX200 EX200-6
AP4212B	110-140-14	E200B
AC4212E	110-140-14	
AC4282F	115-145-14	E320B PC200-7
BW1748	140-470-22	CAT325(用一个)
6V 6899X	165-190-13	CAT330
AW4545E	140-170-20	SK100 SK120
AC4713	160-190-16	SK07-N2
BW5180E	200-235-26	SK220 SK230
BW4815E	240-285-27	SK300
AP2791G	48-70-12	D31
AE3409	65-90-13	D50P-18 PC60-7(小)
AW4215E	110-140-22	D80 D85
AP3527A		HD450-5/7 HD510 HD512 SH100 SH120
AD3519		HD250
AD5346E		ZAX230 ZAX250
AD4153	105*135*14	SK60-1/3 SH200-2
AW4068E		E110B
AE1467		SH60
BW4680E	152*120*21	EX60-2















YEM—H5351
回转立轴油封

YEM-H5354



轴承编号	回转牙箱大轴承对照表/适用机型
22319	E200B(大) E320C(大) E320 PC220-5/6 PC200-3/5/6 SK200 SK07-N2
NJ222	E200B(小) E320
22218	E320C(小) SH200(小) PC200-3/5/6 EX200-2/3/5 HD700-5/7 LS280 PC220-6
22320	SH200(大) DH220-5 HD820 SK210 DH200-2
NJ313	PC120-5(小) HD512(小) SH120 SH265 HD450-7 PC60-5/6(小)
22314	HD512(大) SH120 HD400-7 SH265 PC60-5/6(大)
22316	PC100-5/6(大) PC120-5(大)
NJ217	PC100-5/6(小) PC120-5(小)
NJ221	HD770-2(小) HD800-5 HD900-7
22224	HD770-2(大) EX200-1/2/3/5 PC200-7 HD800-5 HD770-7 UH07-5
22222	HD700/5/7 PC310-5/6 LS2800 PC300-7 SH280 R200-3
22217	SK200-3 SK200 SK07-N2
2222	HD400-2 EX200-1 HD800-7 PC40
30212	PC60-7(小)
33213	PC60-7(大)
22322	PC300-3 HD770
21318	EX400-1 HD220-5 R260-5
22226	HD850G HD1250V DH280-3 PC220-7 R200 R335-7 SH340
21314	SK60-3/5
NU224	PC200-3/5 PC220-3/5/6 PC220-7
32214	PC120-6(小)
32216	PC120-6(大)
NJ314	SK120-5
21317	E120B UH063
30213	SK60-5(小)
30314	SK60-5(大) PC200-6山推
22326	PC400 SH350

<p>YEM-H5355</p>  <p>行走轴承BA240-3 Travel Bearing</p>	<p>YEM-H5356</p>  <p>行走轴承33207 Travel Bearing</p>	<p>YEM-H5357</p>  <p>行走轴承30313 Travel Bearing</p>	<p>YEM-H5358</p>  <p>行走轴承L639249 Travel Bearing</p>
<p>YEM-H5359</p>  <p>行走轴承BA180-4 Travel Bearing</p>	<p>YEM-H5360</p>  <p>行走轴承BA220-6 Travel Bearing</p>	<p>YEM-H5361</p>  <p>行走轴承SF3607 Travel Bearing</p>	<p>YEM-H5362</p>  <p>行走轴承SF4815 Travel Bearing</p>
<p>YEM-H5363</p>  <p>行走轴承SF4831 Travel Bearing</p>	<p>YEM-H5364</p>  <p>行走轴承BA220-1 Travel Bearing</p>	<p>YEM-H5365</p>  <p>行走轴承180BA-2256 Travel Bearing</p>	<p>YEM-H5366</p>  <p>行走轴承BA222-1 Travel Bearing</p>

轴承编号	行走牙箱大轴承对照表/适用机型
SF4831	PC200-3 E200B
SF4815	PC200-5
SF4852/4826	E320 E320B E320C
AC5836/BA289-1A	PC200-6 (6D102) DH220-5
AF4454	PC200-6 (6D95) PC200-7
BA222-1	SH200 SH265 SH260 E312B
BN230-7	LS280 E240 R130
BA240-3	HD700-5/1 SH200-1 HD820
BA220-6	PC120-5 PC120-6 PC100-5 SK120 LS120 SK100 SH100 HD450-7
L5400*9/C5400/0	EX200-1
196L-4SA	EX200-2/3 ZX200
SF3607	PC60-5/3 HD250 SH60
180BA2256	PC60-6 HD250 E70B E307 SK60-6
AC5033	R200-5 HD800-7 HD900-7 DH220 R210 R220-5 HD1250-5 WY230
4631	SK200-1 SK200-2 SK200-5
BA180-4	PC100-3 PC120-3 HD400-5
180BN19	PC100-2 HD700-1/2 HD450-2
AC463240	HD900-5
AC523438-1	SK07-2 SK07N2
7354109	EX120-5
BA220-1	E120B R120B
LL641110	HD400-2
BA230-2	HD770-1/2 HD850 HD880 HD700 HD800-5
BA246-2A	SK230 R290 SH200
300-4	PC300-5
4TLL735449	EX120-2/3 EX100

YEM-H5367



液压泵轴承
HYD Pump Bearing

YEM-H5368



液压泵轴承
HYD Pump Bearing

YEM-H5369



液压泵轴承
HYD Pump Bearing

YEM-H5379



NUP2209

YEM-H5380



22224

YEM-H5381



22320BD1

YEM-H5370



液压泵NUP2206E轴承
HYD Pump Bearing

YEM-H5371



滚针轴承
Kingpin Bearing

YEM-H5372



滚针轴承
Kingpin Bearing

YEM-H5382



6312

YEM-H5383



23024BD1

YEM-H5384



22222

YEM-H5373



滚针轴承
Kingpin Bearing

YEM-H5374



PC120-3 PC150-3

YEM-H5375



十字轴D31/D41/D50/D60/D85

YEM-H5385



6221

YEM-H5386



212355

YEM-H5387



22322

YEM-H5376



4631

YEM-H5377



NJ222M

YEM-H5378



MU224

YEM-H5388



32212

YEM-H5389



22319BD1

YEM-H5390



208266



Radiator Directory
水箱适用车型目录

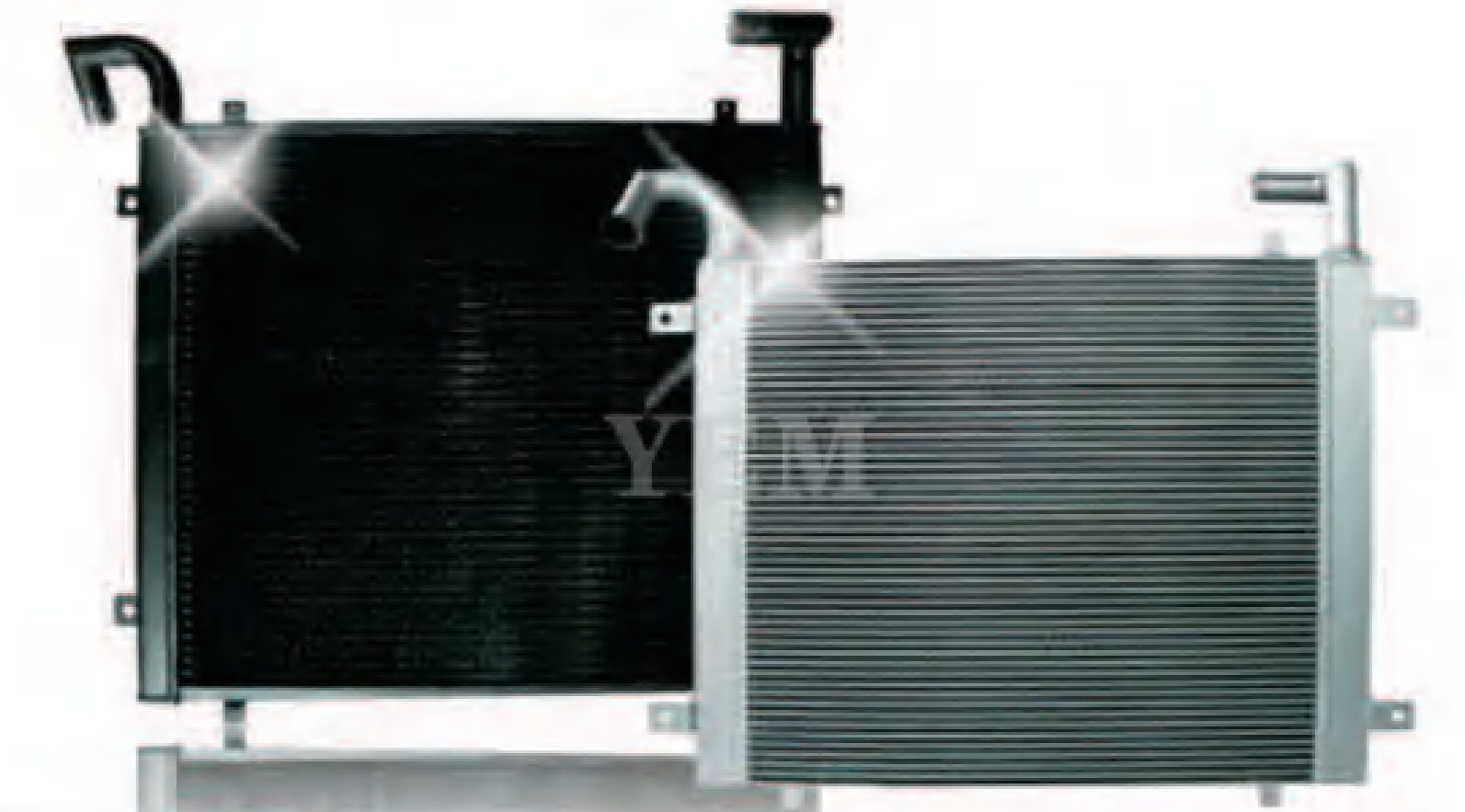

单位: mm

日立	EX120	850*585	大宇	DH220-5	1090*830*135	神钢	SK200-8	995*300
	EX200-2	800*720		DH258-7	1150*895		SK07-2	840*645
	EX200-5	910*780		DH300-7	1026*850		SK07N2	860*760*
	EX200-1	840*645		DH280	1080*820		SK120-3	800*580
	EX220-1	910*716		DH225-7	1020*825		SK200-3	880*760
	EX300-1/3	1020*720		DH55	765*545		SK200-5	980*760
	EX220-2	840*720		DH60-7	765*540		SK200-6	980*760
	ZAX330	1210*445		DH300-5	1014*890		SK200-6E	970*760
	ZAX200	980*820		DH258-5	1014*890		SK220-3	955*720
	ZAX120-6	900*670					SK60-3	610*515
	ZAX50U	590*440					SK200-1	880*770
	ZAX250-3	1180*330						
ZAX240-3	1080*330							
小松	PC55	715*220	加藤	HD700-5	860*780	现代	R200-5	930*740
	PC60-5	610*520		HD800-5	870*765		R220-5	1060*685
	PC60-7(4D95)	670*555		HD450-7	705*645		R60-5	705*490
	PC60-7(4D102)	670*555		HD770-7	860*640		R225-7	1090*830
	PC100-3	645*605		HD820	840*760		R60-7	750*560
	PC120-5	690*645		HD1023	960*760			
	PC120-6	830*645	住友	HD1250-7	1255*950			
	PC200-1	763*870		HD700-7	860*760			
	PC200-2	940*550		卡特			E120B	690*645
	PC200-3	870*760			SH210-5	970*440	E200B	840*735
	PC200-5	980*760			SH120	830*580	E320B	860*760
	PC200-6(6D102)	980*760			SH200A1	970*765	E320	880*760
PC200-6(6D95)	980*760	SH200A3	940*760		E330	1210*890		
PC200-7	980*760	SH240	1020*735		E330C旧	980*855		
PC220-1	905*910	SH280	885*760	E330C	1200*855			
PC220-2	1030*540	SH340	990*760	E330C新	950*456			
PC220-3	1000*760			E320D	1110*408			
PC220-7	1140*760							
PC360-7	1220*890							
PC400-5	1130*930							
PC400-6	1240*1020							
PC400-3	1165*880							
PC220-6	992*800							



Hydraulic Oil Cooler Directory
液压散热器适用车型目录

单位: mm

日立	EX200-2/3	785*740	神钢	SK60	540*530	住友	SH300	1000*895
	EX90	670*700		SK045	650*720		SH60	680*530
	EX60	570*550		SK200-5	932*745		SH160A1	580*510
	EX07-7	750*740		SK09	960*830		SH350	950*930
	EX100-1	650*720		SK07-2	700*730		SH340	850*850
	EX400-3	1035*810		SK04W5	660*620		SH430F2	1015*735
	EX200-1	750*740		SK220-3A	840*840		SH200	840*880
	EX300-3	840*925		SK230	895*780		SH280F2	846*738
	EX400-2	1090*845		SK07N2	840*770		SH135	650*720
	EX200-5	850*830		SK120	650*720		SH120	652*720
	EX220-2	1010*735		SK200-3	865*765		SH220	930*910
	EX220-1	890*830		SK200-6	932*745		SH240	840*765
	EX300-1	1022*725		SK220-6	830*720		SH200-3	780*780
	ZAX200	870*810					SH160F2(60A1)	570*535
ZAX240	1280*510*75			SH200A2	840*875			
				SH60	570*520			
小松	PC60-5/6	585*500	卡特	E312	650*628	大宇	DH220-5	990*730
	PC60-2/3	460*485		E320B	840*735		DH300-5	1130*900
	PC60-7	610*485		E110B(120B)	650*630		DH280	970*810
	PC100-3	680*530		E300	900*855		DH320	970*820
	PC100-6	825*585		E200B	760*735		DH220-3	820*790
	PC100-5	710*580		E320C	850*720	现代	R210-3	1025*635
	PC200-2(220-2)	960*385		E330	1045*1020		R200-3	790*760
	PC200-3	725*700		E320-1	840*735		R290	120*830
	PC200/220-5	925*770		E450	980*990		R200-5	800*750
	PC200-6	990*765		E320-2	840*735			
	PC200-7	960*800		加藤	HD550-5	650*570	富豪200-6	760*900
	PC220-1	840*725			HD820	800*740	徐工200	940*790
	PC220-6	1010*770			HD1250-7	1110*845	柳工200	870*770
	PC22V8	960*725			HD1880	1110*910	三星322	815*750
PC220LC-3	930*698	HD770-2	760*760		UH10	966*805		
PC350(245-6)	1095*840	HD700-7/8/9	860*770					
PC400-3	995*950	HD450-7	640*625					
PC400-5/6	1140*910	HD250-7	600*480					
PC210	1070*765	HD700-5	840*740					
PC300-5	1095*840	HD60	565*530					
PC300-3	980*835	HD400-5	640*580					
PC650	1320*1160	HD800-7	870*840					
PC220-7	1030*870							

中冷器 INTERMEDIATE COOLER

压缩机系列 AIR COMPRESSOR



PC120-6 中冷器



PC200-7 中冷器



E320C 中冷器



E320D 中冷器



ZAX200 中冷器



R225-7 中冷器



SK230-6E 中冷器



PC300-6 中冷器



ZAX240-3燃油散热器



SH燃油散热器



PC-8燃油散热器



JCB200燃油散热器



ZAX330-3燃油散热器



PC10S15C



PC200-6/6D95



PC10PA15C



PC-6



PC-7



PC56-7



PC60-8



PC120



PC300-6



E320C 10S17C



E330C 8PK



CAT 090



CAT 10S17C 8PK



CAT 四方机



CAT306C



CAT307D



CAT320B



CAT320BL



CAT320C



CAT330

压缩机系列 AIR COMPRESSOR

压缩机系列 AIR COMPRESSOR

YEM-H5456  CAT330B	YEM-H5457  CAT方泵	YEM-H5458  CAT进口	YEM-H5459  CAT推土机
YEM-H5460  EXR12	YEM-H5461  EX50	YEM-H5462  EX134A大孔	YEM-H5463  EX134A带耳朵
YEM-H5464  EXR12	YEM-H5465  EX134A	YEM-H5466  ZAX330	YEM-H5467  EX-3大口
YEM-H5468  EX-5	YEM-H5469  EX-6小口	YEM-H5470  EX55	YEM-H5471  EX60
YEM-H5472  EX120-2	YEM-H5473  EX200-3	YEM-H5474  EX240原装机1	YEM-H5475  EX870

YEM-H5476  ZAX200-6	YEM-H5477  VOLVO709 双A	YEM-H5478  VOLVO709 8PK	YEM-H5479  VOLVO8PK
YEM-H5480  VOLVO55	YEM-H5481  VOLVO60	YEM-H5482  VOLVO工程车	YEM-H5483  SK708 上出
YEM-H5484  SK200 SK708 后出	YEM-H5485  SK350-8	YEM-H5486  SK-6	YEM-H5487  SK-8
YEM-H5488  SK60	YEM-H5489  SK75-8	YEM-H5490  R60-5/7	YEM-H5491  R225-7 D21
YEM-H5492  R220-5	YEM-H5493  RV5 24V	YEM-H5494  R-9 带防尘盖	YEM-H5495  R55
YEM-H5496  R215-7	YEM-H5497  R357-9宽脚	YEM-H5498  现代-9	YEM-H5499  大宇 V5 12V

压缩机系列 AIR COMPRESSOR

暖风电机 CONDENSER

YEM-H5500  DH55	YEM-H5501  DH80-J	YEM-H5502  DH300-7	YEM-H5503  DHDX260
YEM-H5504  大宇220-5	YEM-H5505  HD709 后出	YEM-H5506  KATO HD709 上出	YEM-H5507  SH60
YEM-H5508  SHA3	YEM-H5509  SHA5	YEM-H5510  洋马55	YEM-H5511  洋马60
YEM-H5512  三一75电装	YEM-H5513  三一215	YEM-H5514  久保田175	YEM-H5515  久保田185
YEM-H5516  玉柴60	YEM-H5517  玉柴60-8	YEM-H5518  玉柴60新款	YEM-H5519  玉柴85-8
YEM-H5520  玉柴小挖	YEM-H5521  山河智能60	YEM-H5522  石川岛	YEM-H5523  推土机10S13C

YEM-H5524  320D	YEM-H5525  E320B	YEM-H5526  E320	YEM-H5527  E330C
YEM-H5528  CAT307C	YEM-H5529  CAT320B原装	YEM-H5530  CAT320C大电机	YEM-H5531  CAT320C新款
YEM-H5532  CAT320D	YEM-H5533  CAT320C小电机	YEM-H5534  PC200-5	YEM-H5535  PC200-6
YEM-H5536  PC200-7/PC300-7	YEM-H5537  PC-5	YEM-H5538  PC-6	YEM-H5539  PC-6大电机
YEM-H5541  PC-8	YEM-H5542  SK60-8	YEM-H5543  SK60	YEM-H5544  SK-6
YEM-H5546  SH200 SK200-6E	YEM-H5547  EX200-5	YEM-H5548  EX200-3	YEM-H5549  EX210
YEM-H5550  EX120			

暖风电机 CONDENSER

电机总成 MOTOR ASSEMBLY

YEM-H5551  EX450	YEM-H5552  ZAX200-3电喷	YEM-H5553  ZAX/EX	YEM-H5554  R-7	YEM-H5555  R200-5
YEM-H5556  R200-5	YEM-H5557  HD820 SK200-6	YEM-H5558  HD	YEM-H5559  久保田	YEM-H5560  DH220-5
YEM-H5561  DH	YEM-H5562  雷沃150	YEM-H5563  三一365	YEM-H5564  石川岛60	YEM-H5565  山河智能70
YEM-H5566  PC56-8	YEM-H5567  PC装载机	YEM-H5568  SK-8	YEM-H5569  SK超8	YEM-H5570  SK-8
YEM-H5571  ZAX70	YEM-H5572  HITACHI ZAXIS70	YEM-H5573  日立 现代小挖 EX HITACHI	YEM-H5574  DH55	YEM-H5575  DH 大字小挖
YEM-H5576  DH60	YEM-H5577  VOLVO210/360 沃尔沃	YEM-H5578  R60	YEM-H5579  三一75	YEM-H5580  雷沃85

YEM-H5581  电机总成-PC-6	YEM-H5582  电机总成-小松-7	YEM-H5583  电机总成-小松-8	
YEM-H5584  电机总成-卡特320C	YEM-H5585  电机总成-卡特330A	YEM-H5586  电机总成-卡特320D	
YEM-H5587  电机总成-现代	YEM-H5588  R-7总成	YEM-H5589  R225-9总成(8)	YEM-H5590  DH总成
YEM-H5591  R60-9总成	YEM-H5592  R80-7	YEM-H5593  R80-7总成	YEM-H5594  R60-9
YEM-H5595  R60-7	YEM-H5596  EC60	YEM-H5597  SK60	YEM-H5598  三一65

冷凝器AIR CONDITION CONDENSOR

























<p>YEM-H5599</p>  <p>小松 PC 新款 NEW</p>	<p>YEM-H5600</p>  <p>小松 PC-8</p>	<p>YEM-H5601</p>  <p>小松 PC CAT</p>	<p>YEM-H5602</p>  <p>PC-6</p>
<p>YEM-H5603</p>  <p>PC-6老款</p>	<p>YEM-H5604</p>  <p>PC-7</p>	<p>YEM-H5605</p>  <p>PC-7原装款</p>	<p>YEM-H5606</p>  <p>PC-8</p>
<p>YEM-H5607</p>  <p>PC55-5/6</p>	<p>YEM-H5608</p>  <p>PC60-7</p>	<p>YEM-H5609</p>  <p>PC进口</p>	<p>YEM-H5610</p>  <p>现代 R500</p>
<p>YEM-H5611</p>  <p>现代 R50</p>	<p>YEM-H5612</p>  <p>现代 R</p>	<p>YEM-H5613</p>  <p>现代-9冷凝器</p>	<p>YEM-H5614</p>  <p>R-7</p>
<p>YEM-H5615</p>  <p>R-9</p>	<p>YEM-H5616</p>  <p>R55</p>	<p>YEM-H5617</p>  <p>R60-7</p>	<p>YEM-H5618</p>  <p>R60-9</p>

冷凝器AIR CONDITION CONDENSOR

<p>YEM-H5619</p>  <p>R80-7</p>	<p>YEM-H5620</p>  <p>R445-7</p>	<p>YEM-H5621</p>  <p>日立 EX50</p>	<p>YEM-H5622</p>  <p>日立 EX200-3</p>
<p>YEM-H5623</p>  <p>日立 EX</p>	<p>YEM-H5624</p>  <p>日立 EX450</p>	<p>YEM-H5625</p>  <p>EX</p>	<p>YEM-H5626</p>  <p>EX240-3电喷</p>
<p>YEM-H5627</p>  <p>EX-5</p>	<p>YEM-H5628</p>  <p>EX-6</p>	<p>YEM-H5629</p>  <p>EX60</p>	<p>YEM-H5630</p>  <p>EX55</p>
<p>YEM-H5631</p>  <p>EX60-5</p>	<p>YEM-H5632</p>  <p>EX70</p>	<p>YEM-H5633</p>  <p>EX120</p>	<p>YEM-H5634</p>  <p>EX870</p>
<p>YEM-H5635</p>  <p>EX挖机</p>	<p>YEM-H5636</p>  <p>EXZX60</p>	<p>YEM-H5637</p>  <p>ZAX240-3</p>	<p>YEM-H5638</p>  <p>卡特 CAT</p>
<p>YEM-H5639</p>  <p>CAT306C</p>	<p>YEM-H5640</p>  <p>CAT307C</p>	<p>YEM-H5641</p>  <p>CAT320B公制口</p>	<p>YEM-H5642</p>  <p>CAT320C</p>









冷凝器 AIR CONDITION CONDENSOR

冷凝器 AIR CONDITION CONDENSOR

YEM-H5643  CAT320CU	YEM-H5644  CAT320D	YEM-H5645  CAT330C	YEM-H5646  CAT330D
YEM-H5647  CAT三菱压板	YEM-H5648  CAT小挖	YEM-H5649  大宇 DH	YEM-H5650  DH55
YEM-H5651  DH-5	YEM-H5652  DH80-J	YEM-H5653  DH55	YEM-H5654  DH225-7
YEM-H5655  DHDX60	YEM-H5656  DH300	YEM-H5657  SK-8	YEM-H5658  SK60压板
YEM-H5659  SK200-6	YEM-H5660  SK带瓶	YEM-H5661  神钢/住友 SK	YEM-H5662  VOLVO55
YEM-H5663  沃尔沃 VOLVO	YEM-H5664  VOLVO55	YEM-H5665  VOLVO60带瓶	YEM-H5666  VOLVO210

YEM-H5667  VOLVO210带瓶	YEM-H5668  VOLVO290	YEM-H5669  VOLVO360反口	YEM-H5670  VOLVO360正
YEM-H5671  VOLVO460带瓶	YEM-H5672  VOLVO130	YEM-H5673  SH200A5	YEM-H5674  住友 SH
YEM-H5675  SH	YEM-H5676  SH老款	YEM-H5677  CAT308	YEM-H5678  洋马60
YEM-H5679  SK超8	YEM-H5680  HD1203	YEM-H5681  HD1430	YEM-H5682  久保田
YEM-H5683  临工210带瓶	YEM-H5684  柳工	YEM-H5685  柳工60	YEM-H5686  柳工220
YEM-H5687  柳工225	YEM-H5688  柳工825	YEM-H5689  玉柴85	YEM-H5690  玉柴230-8

蒸发箱 COOLING RADIATOR

<p>YEM-H5691</p>  <p>CAT 新款</p>	<p>YEM-H5692</p>  <p>CAT 最新款</p>	<p>YEM-H5693</p>  <p>CAT老款</p>	<p>YEM-H5694</p>  <p>CAT320B</p>
<p>YEM-H5695</p>  <p>CAT320C</p>	<p>YEM-H5696</p>  <p>CAT320C老款</p>	<p>YEM-H5697</p>  <p>CAT320D</p>	<p>YEM-H5698</p>  <p>PC-2-3</p>
<p>YEM-H5699</p>  <p>PC-5</p>	<p>YEM-H5700</p>  <p>PC-6</p>	<p>YEM-H5701</p>  <p>PC-7新款</p>	<p>YEM-H5702</p>  <p>PC56-8</p>
<p>YEM-H5703</p>  <p>PC75</p>	<p>YEM-H5704</p>  <p>PC360-7</p>	<p>YEM-H5705</p>  <p>PC老款</p>	<p>YEM-H5706</p>  <p>PC</p>
<p>YEM-H5707</p>  <p>PC新款</p>	<p>YEM-H5708</p>  <p>PC最新款</p>	<p>YEM-H5709</p>  <p>R老款</p>	<p>YEM-H5710</p>  <p>R-9</p>

蒸发箱 COOLING RADIATOR



<p>YEM-H5711</p>  <p>R-7压板</p>	<p>YEM-H5712</p>  <p>R55</p>	<p>YEM-H5713</p>  <p>R60-9</p>	<p>YEM-H5714</p>  <p>R新款</p>
<p>YEM-H5715</p>  <p>R最新款</p>	<p>YEM-H5716</p>  <p>R-5双尾</p>	<p>YEM-H5717</p>  <p>EX330</p>	<p>YEM-H5718</p>  <p>EX-3</p>
<p>YEM-H5719</p>  <p>EX-5</p>	<p>YEM-H5720</p>  <p>EX-6</p>	<p>YEM-H5721</p>  <p>EX70</p>	<p>YEM-H5722</p>  <p>EX</p>
<p>YEM-H5723</p>  <p>DH-9</p>	<p>YEM-H5724</p>  <p>DH55</p>	<p>YEM-H5725</p>  <p>DH</p>	<p>YEM-H5726</p>  <p>DH-7</p>
<p>YEM-H5727</p>  <p>SK</p>	<p>YEM-H5728</p>  <p>SK-6</p>	<p>YEM-H5729</p>  <p>SK-8</p>	<p>YEM-H5730</p>  <p>SK-8</p>
<p>YEM-H5731</p>  <p>VOLVO</p>	<p>YEM-H5732</p>  <p>HD1430</p>		

暖风小水箱 HEATING RADIATOR

<p>YEM-H5733</p>  <p>PC200-7新款 new</p>	<p>YEM-H5734</p>  <p>PC220-7</p>	<p>YEM-H5735</p>  <p>PC-6</p>	<p>YEM-H5736</p>  <p>PC进口版</p>
<p>YEM-H5737</p>  <p>PC-7</p>	<p>YEM-H5738</p>  <p>PC-8</p>	<p>YEM-H5739</p>  <p>PC60-7</p>	<p>YEM-H5740</p>  <p>CAT307c</p>
<p>YEM-H5741</p>  <p>CAT320B/D</p>	<p>YEM-H5742</p>  <p>CAT320C</p>	<p>YEM-H5743</p>  <p>CAT330</p>	<p>YEM-H5744</p>  <p>CAT320B</p>
<p>YEM-H5745</p>  <p>CAT320C</p>	<p>YEM-H5746</p>  <p>CAT330</p>	<p>YEM-H5747</p>  <p>SK-8</p>	<p>YEM-H5748</p>  <p>SK200-6</p>
<p>YEM-H5749</p>  <p>SK-6</p>	<p>YEM-H5750</p>  <p>SK-8</p>	<p>YEM-H5751</p>  <p>EX</p>	<p>YEM-H5752</p>  <p>EX</p>

暖风小水箱 HEATING RADIATOR

<p>YEM-H5753</p>  <p>EX70</p>	<p>YEM-H5754</p>  <p>EX200-5</p>	<p>YEM-H5755</p>  <p>R220-5</p>	<p>YEM-H5756</p>  <p>R-5铜</p>
<p>YEM-H5757</p>  <p>R55</p>	<p>YEM-H5758</p>  <p>R60-9</p>	<p>YEM-H5759</p>  <p>R225-7</p>	<p>YEM-H5760</p>  <p>R225-7铜</p>
<p>YEM-H5761</p>  <p>R225-9</p>	<p>YEM-H5762</p>  <p>R胶轮挖机</p>	<p>YEM-H5763</p>  <p>DH</p>	<p>YEM-H5764</p>  <p>DH新款</p>
<p>YEM-H5765</p>  <p>DH55</p>	<p>YEM-H5766</p>  <p>DH220-5</p>	<p>YEM-H5767</p>  <p>VOLVO</p>	<p>YEM-H5768</p>  <p>VOLVO 沃尔沃</p>
<p>YEM-H5769</p>  <p>SH200</p>	<p>YEM-H5770</p>  <p>SH</p>	<p>YEM-H5771</p>  <p>SH75</p>	<p>YEM-H5772</p>  <p>柳工225</p>
<p>YEM-H5773</p>  <p>玉柴85</p>			

YEM-H5774  E320C	YEM-H5775  E320C	YEM-H5776  小松膨胀阀	YEM-H5777  PC-6
YEM-H5778  PC-7	YEM-H5779  大宇膨胀阀	YEM-H5780  DH	YEM-H5781  神钢膨胀阀
YEM-H5782  SK	YEM-H5783  日立膨胀阀	YEM-H5784  EX	YEM-H5785  R-7
YEM-H5786  R-9	YEM-H5787  VOLVO	YEM-H5788  柳工	YEM-H5789  徐工
YEM-H5790  现代50膨胀阀	YEM-H5791  现代膨胀阀	YEM-H5792  DH60	YEM-H5793  HD

YEM-H5794  CAT320B	YEM-H5795  EX70	YEM-H5796  EX老款	YEM-H5797  山推
YEM-H5798  R60	YEM-H5799  玉柴85	YEM-H5800  大宇	YEM-H5801  日立-5
YEM-H5802  小松卡特	YEM-H5803  神钢住友	YEM-H5804  DH	YEM-H5805  CAT老款
YEM-H5806  雷沃	YEM-H5807  临工	YEM-H5808  柳工134口	YEM-H5809  EX
YEM-H5810  EX老款	YEM-H5811  SK-6	YEM-H5812  SK-8	YEM-H5813  VOLVO
YEM-H5814  R	YEM-H5815  R老款	YEM-H5816  PC	

空调滤芯 AIR PARTS







 PC200-7外置	 PC200-7内置	 PC200-8外置/内置	 PC200-6 老款	 PC200-6 新款
 PC55内	 PC55外	 PC60-7	 PC78	 PC200-7内虑
 PC200-7外	 PC老款	 ZAX外置	 ZAX内置 534241-7600	 EX-3内
 EX-3外	 EX-5内	 EX-5外	 EX70	 EX450
 EX470	 EXZX60	 EX200-5 外置	 EX200-5 内置	 SK200-8 外置































空调滤芯 AIR PARTS

 SK200-8内置 51186-41990	 神钢空调滤	 神钢空调滤	 SK-6内	 SK-6外
 DH (斗山)	 DH-9	 DHDX60	 DHDX260	 DHDX300
 DH新款	 DAEWOO 大字新款	 DAEWOO 大字旧款	 CAT320内	 CAT330
 CATE320B外置	 CAT铁边	 CAT320	 CAT320c内	 CAT320c外
 CAT320D	 VOLVO内	 VOLVO外	 外145 内14503269 VOLVO空调滤内、外置	 HYUNDAI 现代 外置

空调滤芯 AIR PARTS/离合器线圈 CLUTCH COIL

其他空调件
OTHER AIR CONDITIONING PARTS

YEM-H5867  HYUNDAI 现代 内置	YEM-H5868  R-7	YEM-H5869  R60-9	YEM-H5870  R75
YEM-H5871  R-9	YEM-H5872  HD1430	YEM-H5873  SH内	YEM-H5874  SH外
YEM-H5875  住友内置 FT-6804 51186-41951	YEM-H5876  SH直喷	YEM-H5877  住友 外置	YEM-H5878  708线圈
YEM-H5879  CAT 10S15C 单	YEM-H5880  CAT 10S17C 8PK	YEM-H5881  CAT 10S17C 双A	YEM-H5882  CAT线圈
YEM-H5883  EX DKS	YEM-H5884  EX线圈	YEM-H5885  HD 10PA15C 4PK	YEM-H5886  HD V5
YEM-H5887  R D21	YEM-H5888  SK 708 709	YEM-H5889  VOLVO7098PK	YEM-H5890  VOLVO709双A

YEM-H5891  PC200-6	YEM-H5892  PC200-7	YEM-H5893  CAT306C	YEM-H5894  CAT307C-308C	YEM-H5895  CAT320B
YEM-H5896  EX55	YEM-H5897  EX60-5	YEM-H5898  EX120	YEM-H5899  SK60	YEM-H5900  SK200-6
YEM-H5901  VOLVO55	YEM-H5902  R55	YEM-H5903  R60-7	YEM-H5904  PC电阻	YEM-H5905  CAT原厂
YEM-H5906  ZAX-3	YEM-H5907  EX-5	YEM-H5908  EX-6	YEM-H5909  SK-6	YEM-H5910  SK-8
YEM-H5911  EC	YEM-H5912  R-7	YEM-H5913  R-9	YEM-H5914  玉柴	YEM-H5915  HD
YEM-H5916  DH	YEM-H5917  EX120	YEM-H5918  PC100-6	YEM-H5919  DH	YEM-H5920  PC300-7支架

空调面板 AIR CONDITIONING PANEL

<p>YEM-H5921</p>  <p>雷沃 玉柴 24V(除霜)</p>	<p>YEM-H5922</p>  <p>雷沃 玉柴 24V(新风)</p>	<p>YEM-H5923</p>  <p>玉柴 (除霜) 12V空调面板</p>
<p>YEM-H5924</p>  <p>玉柴 (新风) 12V空调面板</p>	<p>YEM-H5925</p>  <p>福田、雷沃、玉柴(12V/24V)</p>	<p>YEM-H5926</p>  <p>玉柴135/230/210-8/240 TYJ3-148A/120522-071</p>
<p>YEM-H5927</p>  <p>玉柴 YC35/60/85机型老款/山河智能</p>	<p>YEM-H5928</p>  <p>山河智能 12V</p>	<p>YEM-H5929</p>  <p>柳工906D/907D/908D</p>
<p>YEM-H5930</p>  <p>柳工225</p>	<p>YEM-H5931</p>  <p>柳工215C/225 厦工815/821/150 45100413910477</p>	<p>YEM-H5932</p>  <p>柳工908</p>
<p>YEM-H5933</p>  <p>徐工</p>	<p>YEM-H5934</p>  <p>徐工 135B/150D/200C 215/225/230/235</p>	<p>YEM-H5935</p>  <p>徐工新款 24V</p>

空调面板 AIR CONDITIONING PANEL

<p>YEM-H5936</p>  <p>厦工DS700 24V</p>	<p>YEM-H5937</p>  <p>厦工822/815/825</p>	<p>YEM-H5938</p>  <p>龙工/厦工 DS-900 24V</p>
<p>YEM-H5939</p>  <p>龙工225/厦工815/825/822</p>	<p>YEM-H5940</p>  <p>HD820</p>	<p>YEM-H5941</p>  <p>加藤512/820/1023/1430</p>
<p>YEM-H5942</p>  <p>斗山大宇DX260/300/350(24V)</p>	<p>YEM-H5943</p>  <p>斗山/大宇 150-7/210-7 220-7/225-7/-5</p>	<p>YEM-H5944</p>  <p>斗山大宇DX260/300/350(12V) C20033-2290</p>
<p>YEM-H5945</p>  <p>临工85/60/65</p>	<p>YEM-H5946</p>  <p>临工DS700 12V</p>	<p>YEM-H5947</p>  <p>三一-60/临工60</p>
<p>YEM-H5948</p>  <p>住友 SH210/350/240</p>	<p>YEM-H5949</p>  <p>福田 雷沃</p>	<p>YEM-H5950</p>  <p>福田雷沃</p>
<p>YEM-H5951</p>  <p>凯斯空调面板</p>	<p>YEM-H5952</p>  <p>凯斯360/350/210</p>	<p>YEM-H5953</p>  <p>开元60</p>

空调面板 AIR CONDITIONING PANEL

空调面板 AIR CONDITIONING PANEL

<p>YEM—H5954</p>  <p>小松PC-7新款(2510)</p>	<p>YEM—H5955</p>  <p>小松PC-7老款(0160)</p>	<p>YEM—H5956</p>  <p>小松 200-6/220-6 200-6E/120-6 146430-4521</p>
<p>YEM—H5957</p>  <p>小松PC380装载机</p>	<p>YEM—H5958</p>  <p>PC-8空调面板</p>	<p>YEM—H5959</p>  <p>三一 55/65/60</p>
<p>YEM—H5960</p>  <p>三一135-8/215-8(3830)</p>	<p>YEM—H5961</p>  <p>三一215-8</p>	<p>YEM—H5962</p>  <p>徐工 150/215D/251CA/215CA 三一195雷沃200D</p>
<p>YEM—H5963</p>  <p>三一 60-8</p>	<p>YEM—H5964</p>  <p>三一 55C/65C/60</p>	<p>YEM—H5965</p>  <p>三一-8空调面板</p>
<p>YEM—H5966</p>  <p>三一55 65空调面板</p>	<p>YEM—H5967</p>  <p>三一 60/65/75-8(11键)</p>	<p>YEM—H5968</p>  <p>卡特 320D/324D/329D 330/336D/345D 293-1136/146570-350/237040-032</p>

<p>YEM—H5969</p>  <p>卡特320C/315C/330C/312C 157-3210 146430-822 237040-012</p>	<p>YEM—H5970</p>  <p>CAT320CD2/324CD2 325CD2/330CD2 A0039/396-6895/146570-7950</p>	<p>YEM—H5971</p>  <p>E320D大灯雨刮控制器</p>
<p>YEM—H5972</p>  <p>E320C大灯雨刮控制器</p>	<p>YEM—H5973</p>  <p>E312B/320B</p>	<p>YEM—H5974</p>  <p>现代-7 11N6-90031</p>
<p>YEM—H5975</p>  <p>现代R150-9/220-9/225-9/215-9 1106-9037</p>	<p>YEM—H5976</p>  <p>现代R55/60-7</p>	<p>YEM—H5977</p>  <p>神钢SK200/210/220/230-8</p>
<p>YEM—H5978</p>  <p>神钢SK-6</p>	<p>YEM—H5979</p>  <p>神钢SK-8</p>	<p>YEM—H5980</p>  <p>沃尔沃140/210/240 290/360/460B 14530573</p>
<p>YEM—H5981</p>  <p>沃尔沃 EC480D/360B 380D/220D/210D 14594714</p>	<p>YEM—H5982</p>  <p>日立 ZAX60/70/200/230 250/330/360/450 503722-3050</p>	<p>YEM—H5983</p>  <p>日立120-6/450-3/470(8272)</p>



K3V63DT



K3V112DT



K3V112DTP(电控)



神钢/KOBELCO SK200-6



神钢/KOBELCO SK200-8/250-8



神钢/KOBELCO SK230-6E



K3V112DTP



K3V112DTP+PTO



K3V112DTP-OE11-14T

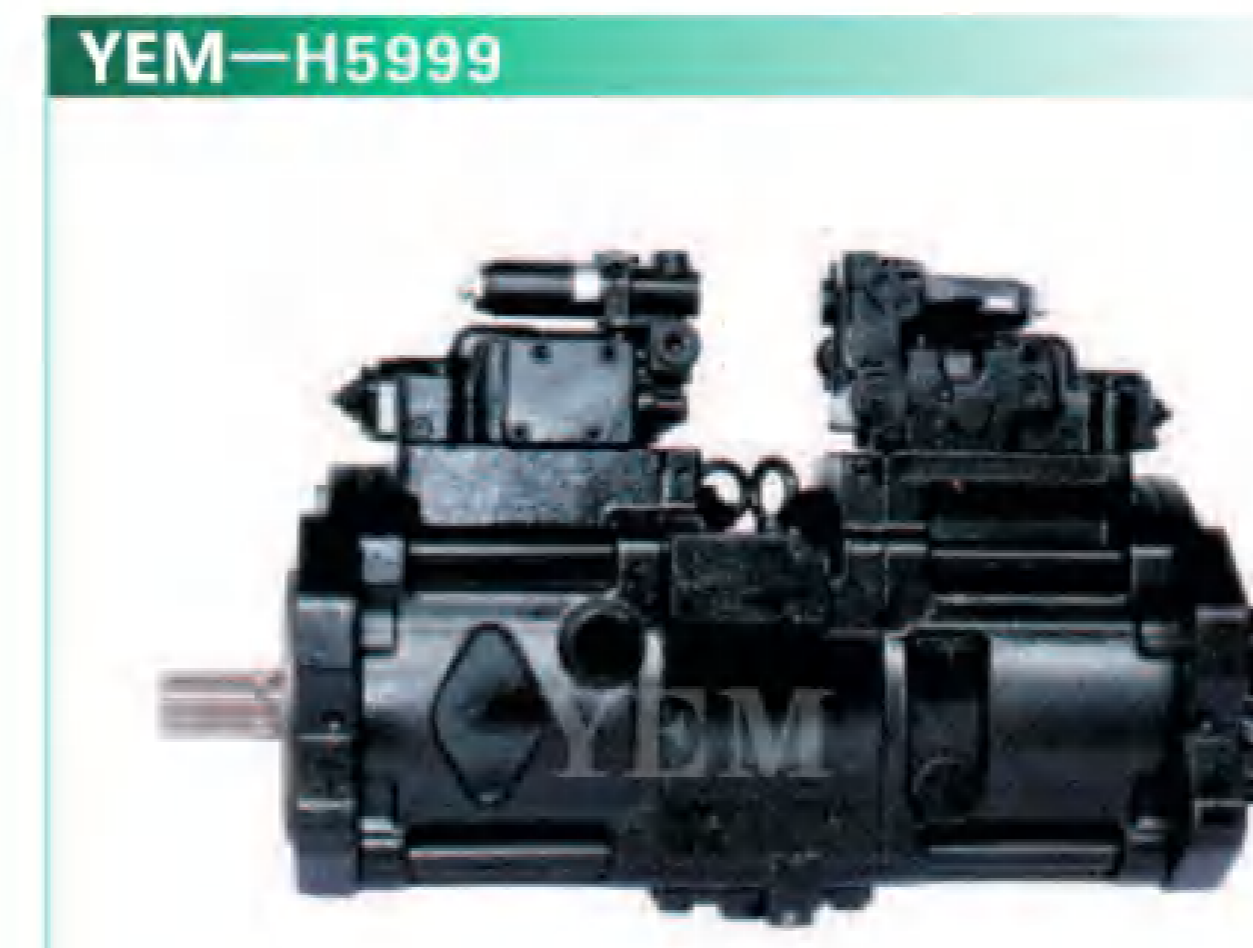

神钢/KOBELCO SK330-6/-6E



神钢/KOBELCO SK330-6/-6E



神钢/KOBELCO SK350-8



K3V112S



K3V140DT



K3V180DT



神钢/KOBELCO SK450-6/-6E



住友/SUMITOMO SH130-5

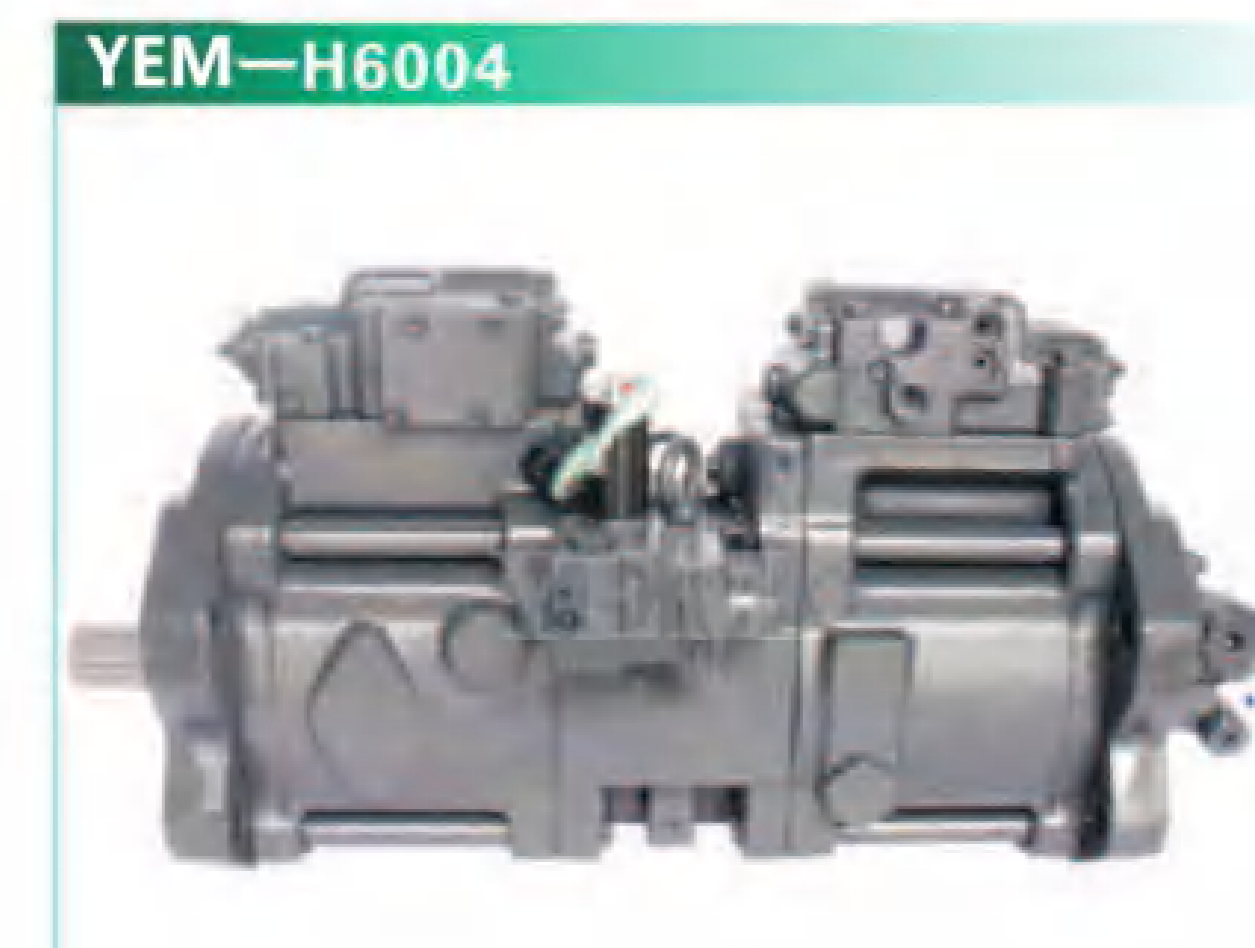

住友/SUMITOMO SH200-1



K5V140DTP (电控)



K3V140DT



神钢/KOBELCO SK135-8/140-8

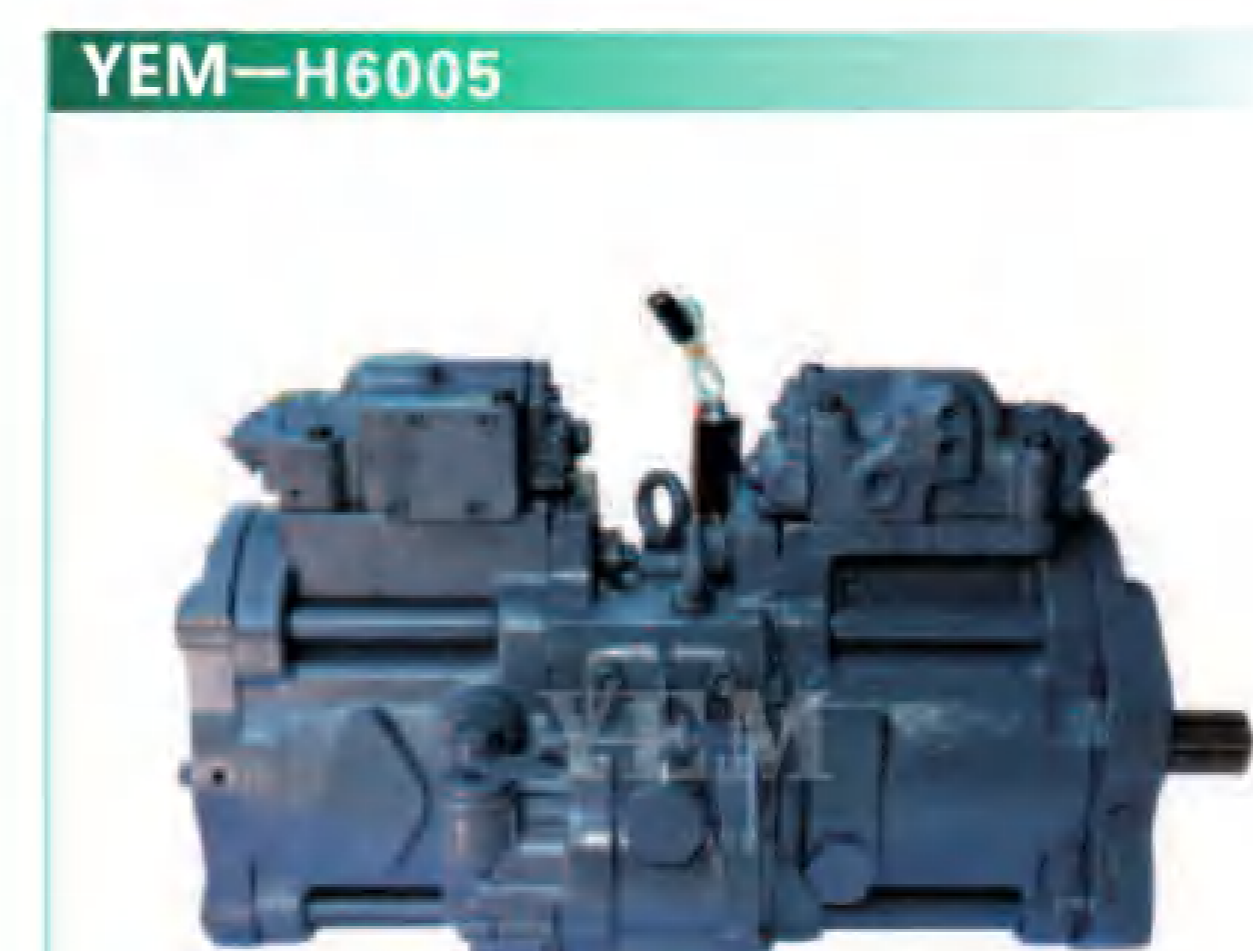

住友/SUMITOMO SH200A3



住友/SUMITOMO SH240-5

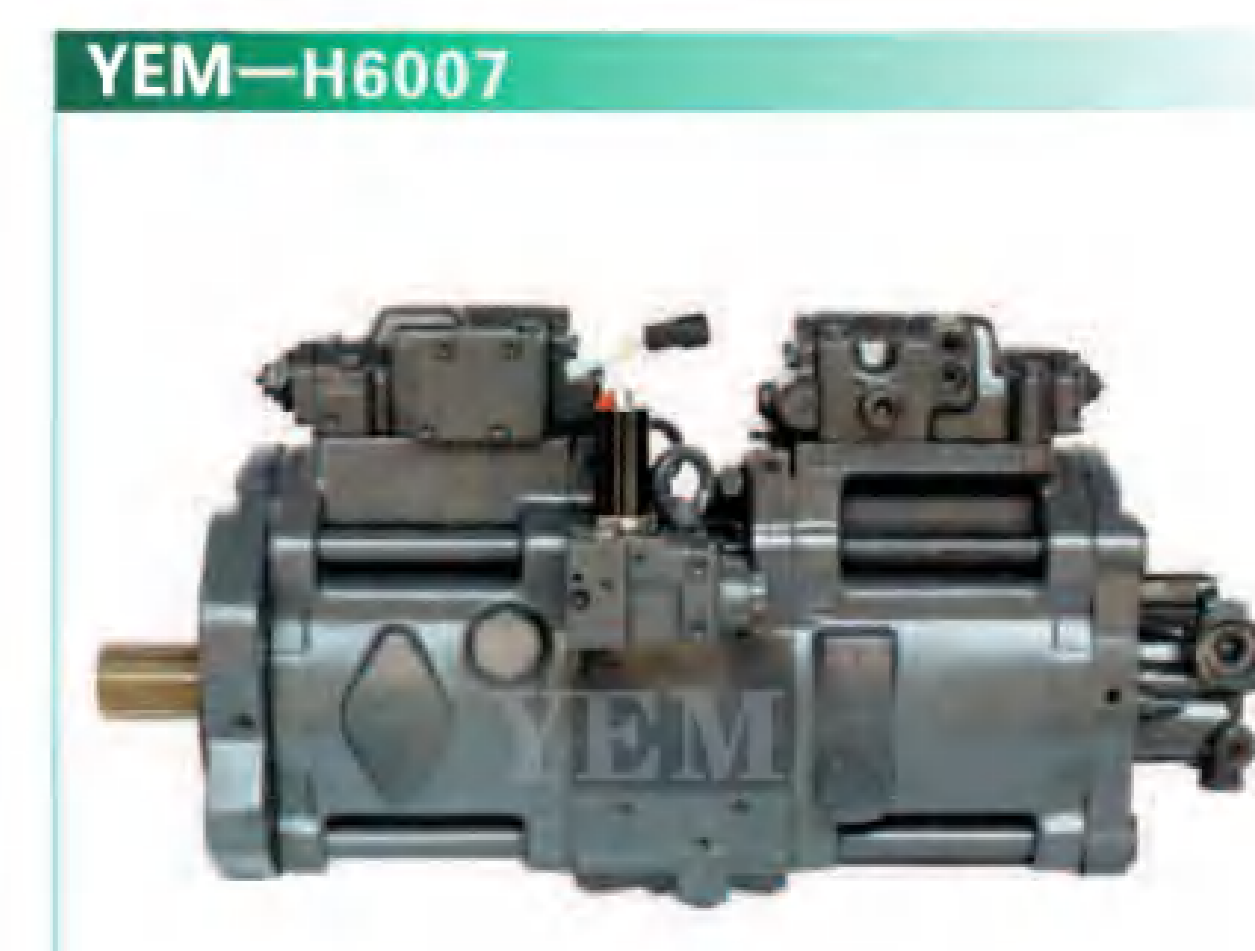

住友/SUMITOMO SH300A3

YEM-H6008



住友/SUMITOMO SH350-5

YEM-H6009

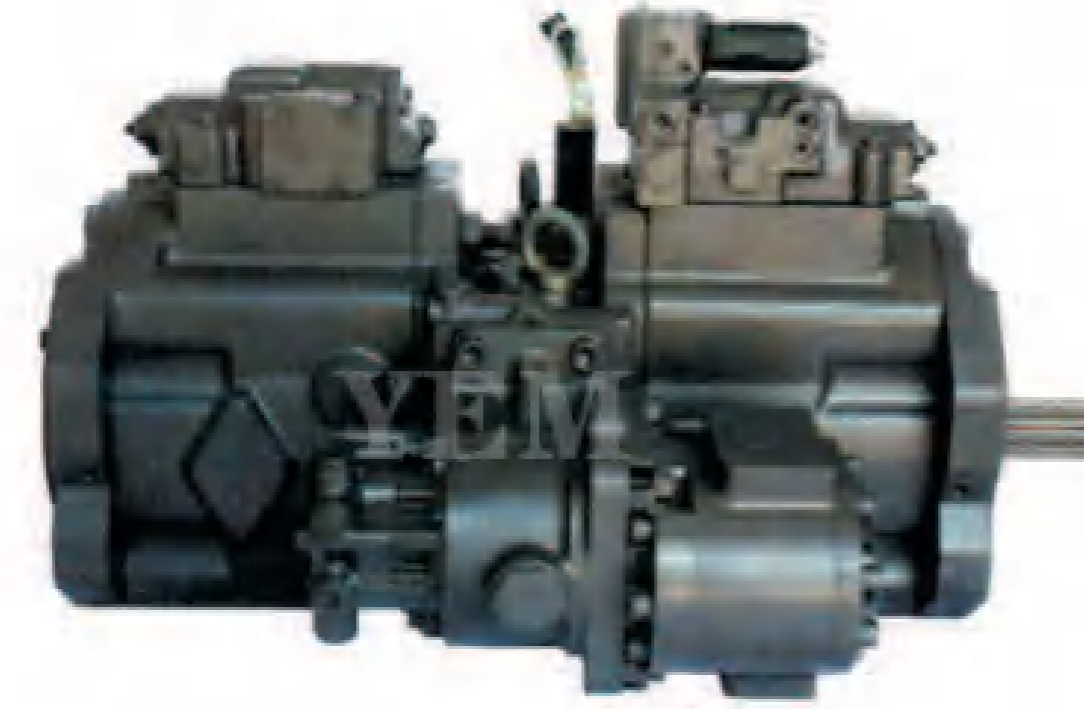

住友/SUMITOMO SH460-5

YEM-H6010

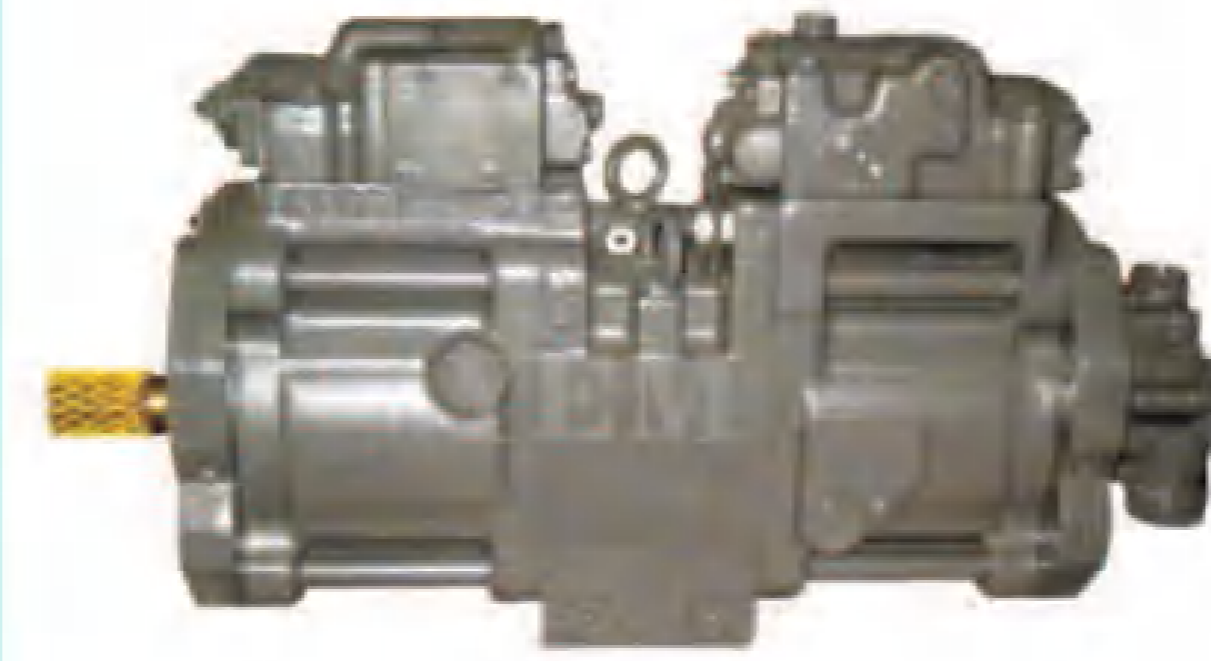

沃尔沃/VOLVO EC130

YEM-H6020



三一/SANY SY335

YEM-H6021

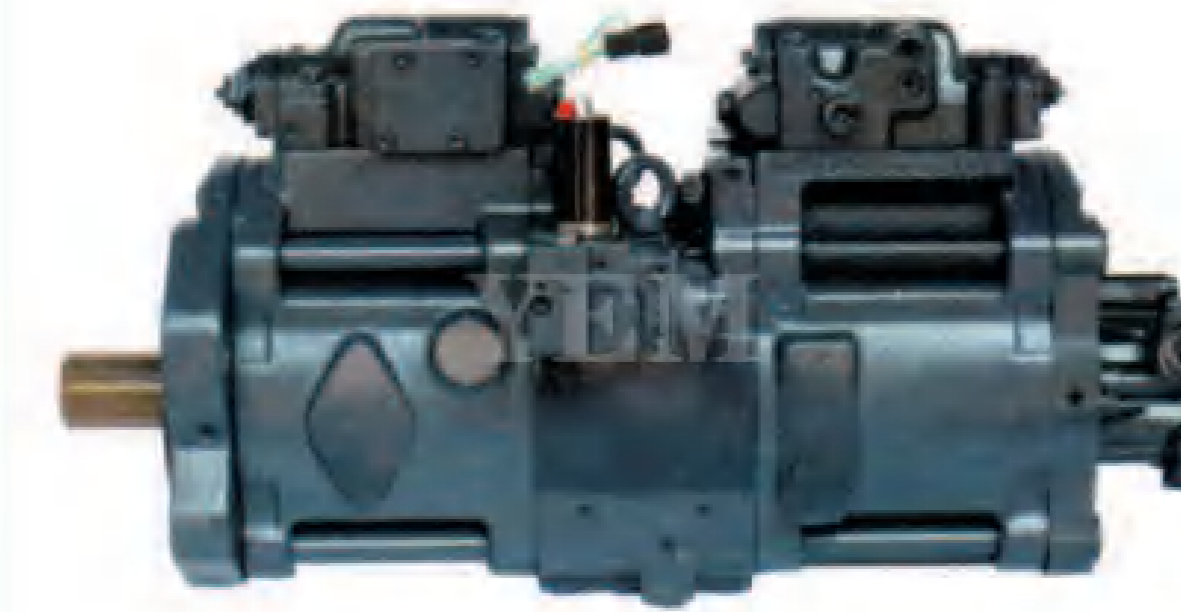

现代/HYUNDAI R305-7

YEM-H6022

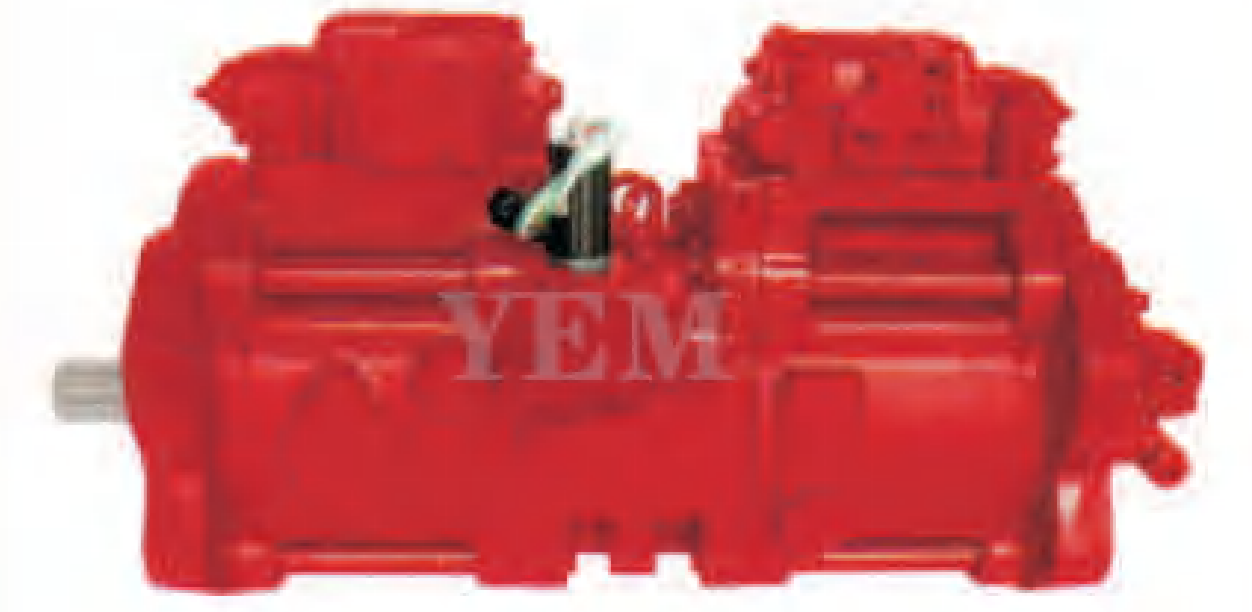

柳工/LIUGONG LG922EII/922EIII

YEM-H6011



沃尔沃/VOLVO EC210/240B

YEM-H6012



沃尔沃/VOLVO EC290

YEM-H6013



沃尔沃/VOLVO EC360

YEM-H6023



卡特/CARTER CAT312

YEM-H6024



凯斯/CASE CX240-5

YEM-H6025

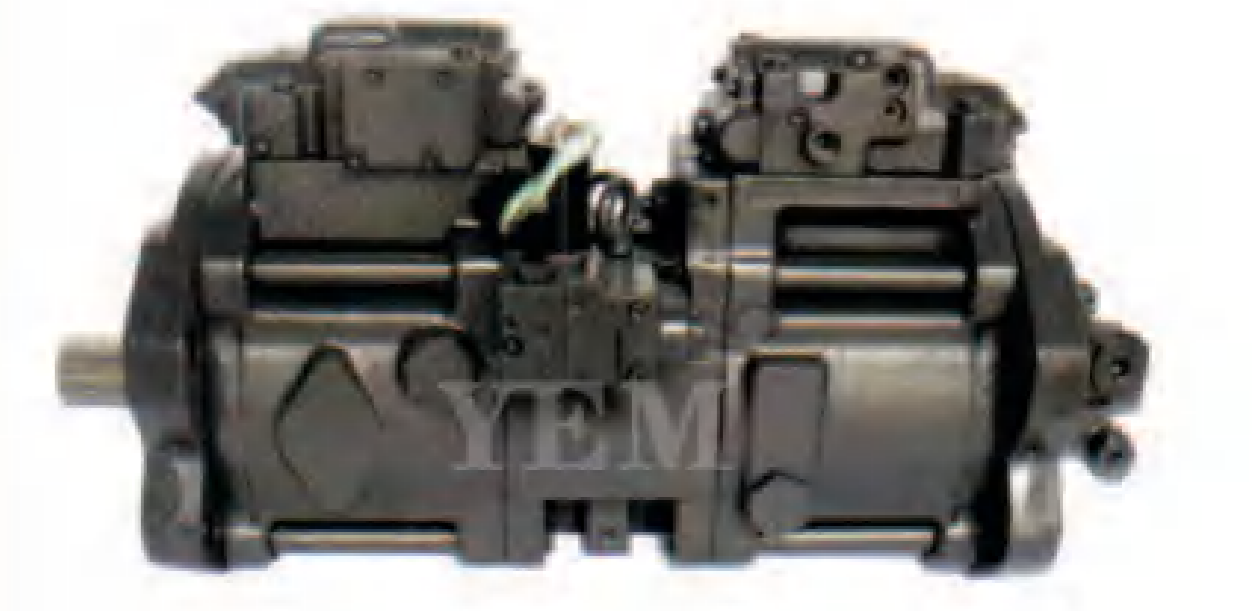

徐工/XCMG 中联/ZOOMLION
山河/SUNWARD 厦工/SAHM 20T

YEM-H6014

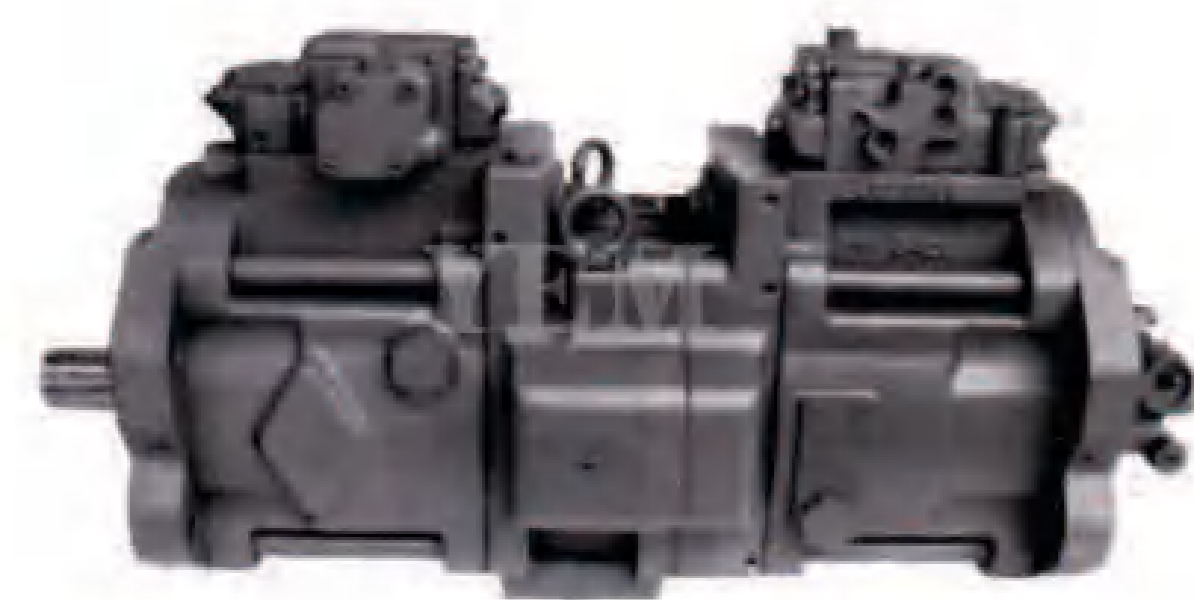

沃尔沃/VOLVO EC460

YEM-H6015

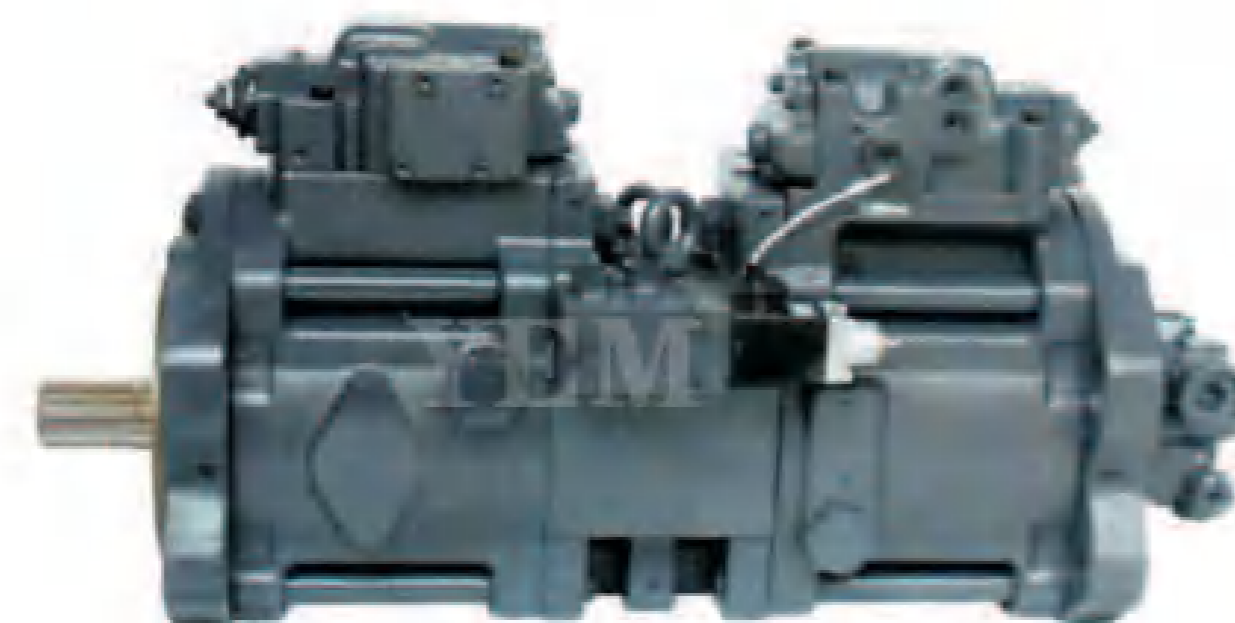

加藤/KATO HD700-7/820R

YEM-H6016

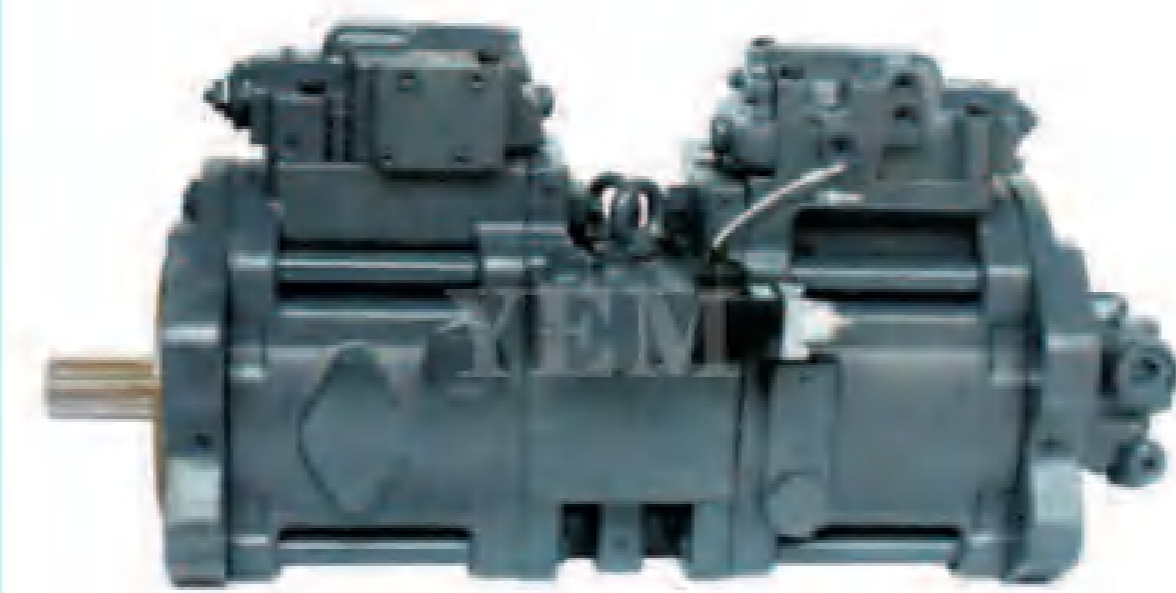

加藤/KATO HD10231430

YEM-H6026



K3V112DT(改PC)

YEM-H6027



K3V112S PC

YEM-H6028



小松/MOMATSU PC200-7/-8

YEM-H6017



加藤/KATO HD2045

YEM-H6018

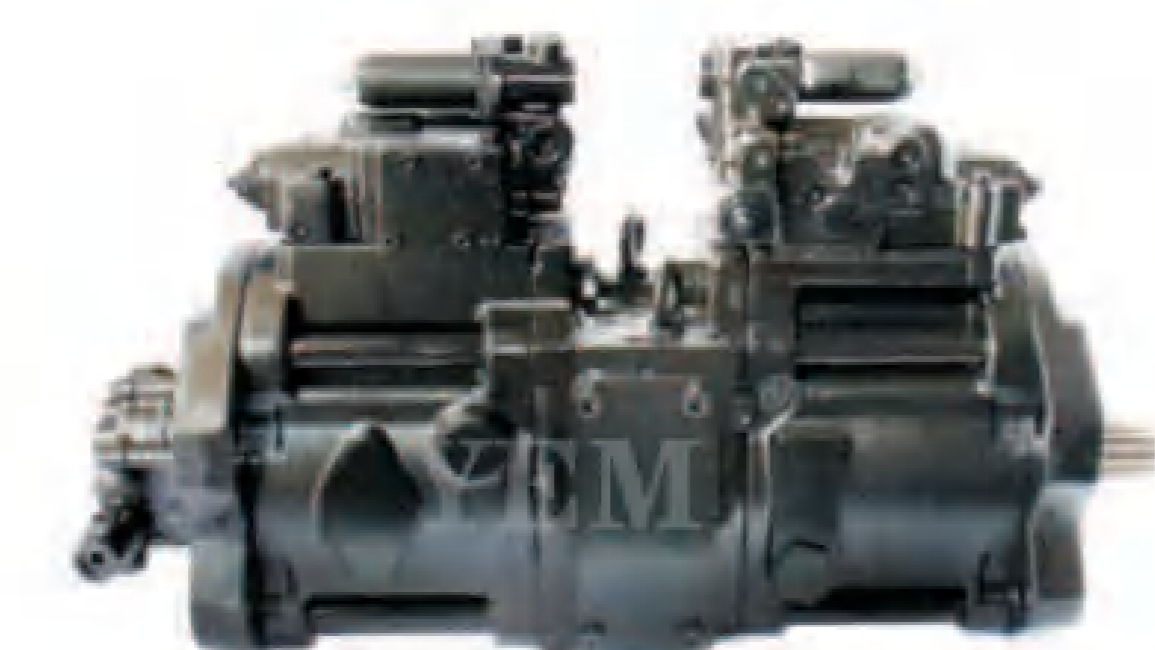

三一/SANY SY205/215

YEM-H6019



三一/SANY SY215/235

YEM-H6029



卡特/CARTER E330D
神钢/KOBELCO SK460-8
日立/HITACHI ZX450-1/470-3
现代/HYUNDAI R450-7
柳工/LIUGONG LG945/948

YEM-H6030

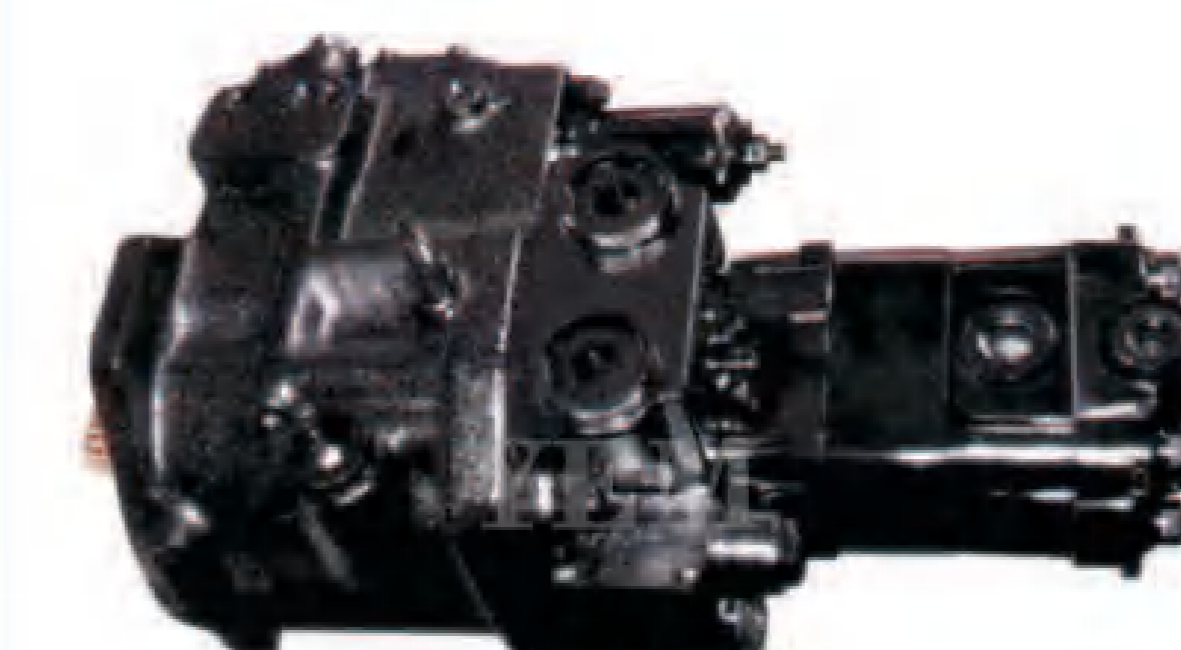

神钢/KOBELCO SK60SR

YEM-H6031



A10V063

YEM-H6032



力士乐/REXROTH A10V071

YEM-H6033



柱塞泵PSVD2-27E

YEM-H6034



B0600-21026
PSVD2-21E-16
S/N 6X0041

YEM-H6047



HP2013-XR
LENGTH-4Q-14.4
1305N17

YEM-H6048



E307

YEM-H6049



PVK-2B-505-N-4554C
6Y00030

YEM-H6035



柱塞泵K3VL80

YEM-H6036

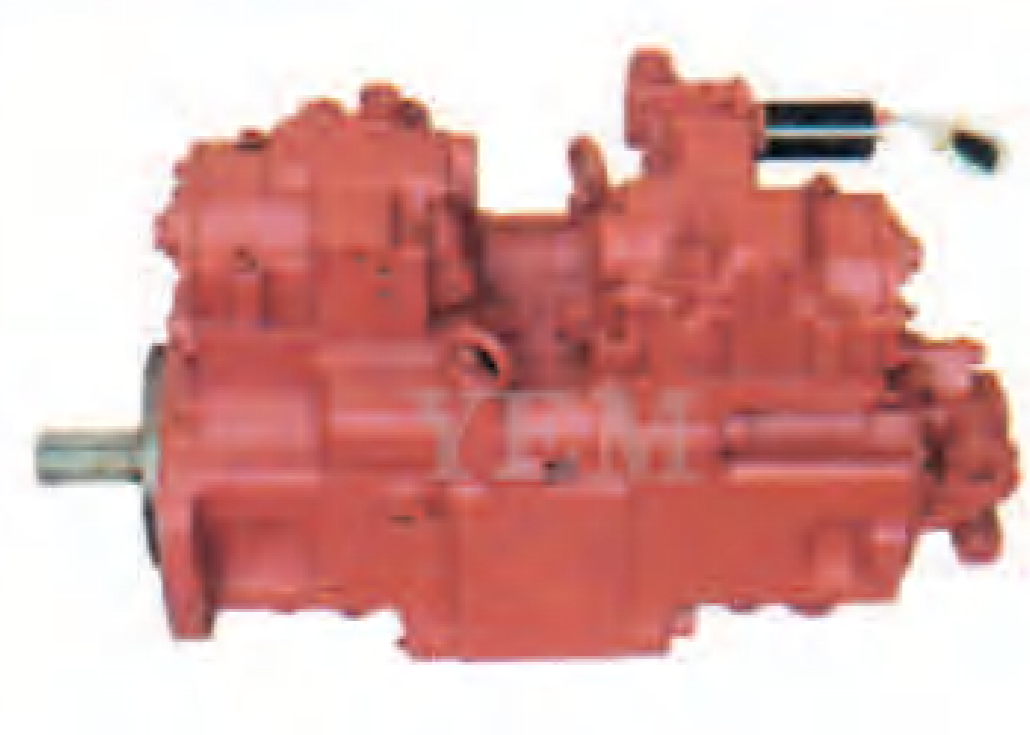

柱塞泵K7V63DTP1

YEM-H6037



柱塞泵PVD-3B-54P-
18G5-4185F
2500011

YEM-H6050



A11V075
25835307

YEM-H6051



AP2D56LV/31RS7-814-0
R971061889
50241802

YEM-H6052



PVK2B505

YEM-H6038



柳工/LIUGONG
玉柴/YUCHAI 8T

YEM-H6039



柱塞泵PVK-3B-725-N-5269A
4500006

YEM-H6040



柱塞泵K3SP36C

YEM-H6053



YA00025708
50133661

YEM-H6054



柱塞泵PVC90RC08

YEM-H6055



PVD-28-40P-6AG3-5220A

YEM-H6041



SF1305

YEM-H6042



AP2D25

YEM-H6043



AP2D25带电磁阀

YEM-H6056



AP2D36带电磁阀

YEM-H6057



AP2D36

YEM-H6058

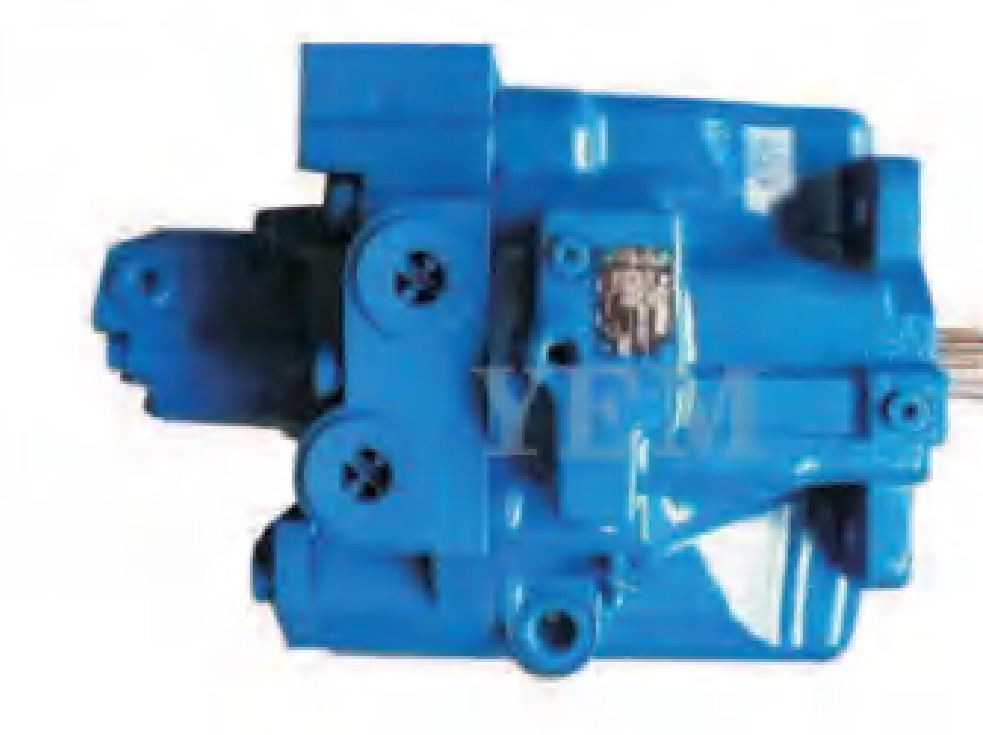

AP2D36

YEM-H6044



DOOSAN
AP2D28

YEM-H6045



AP2D28带电磁阀

YEM-H6046

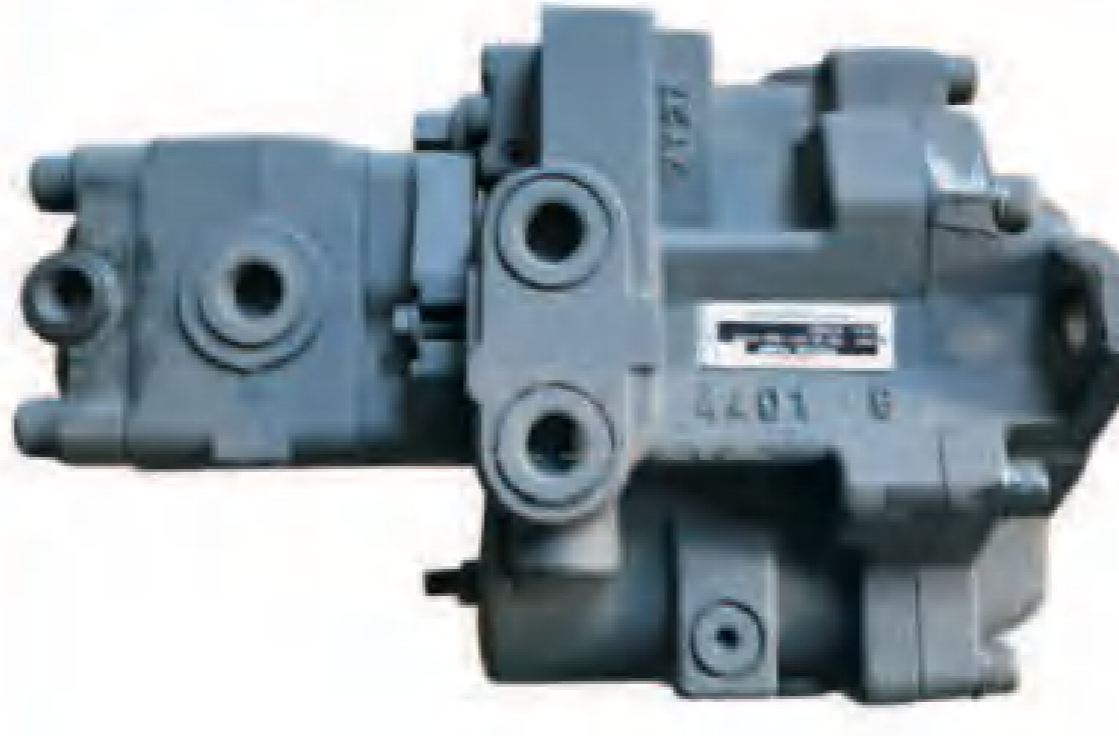

8100007

YEM-H6059

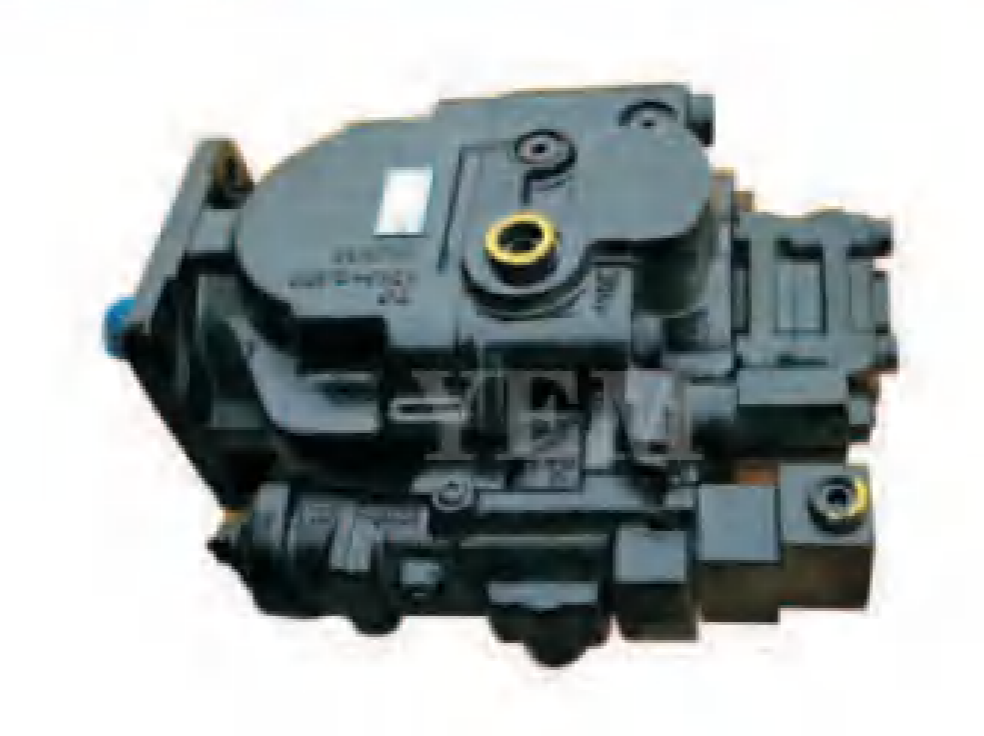

PVC90

YEM-H6060



AP2D15

YEM-H6061



AP2D15长泵

调节器(提升器) REGULATOR

调节器(提升器) REGULATOR

YEM-H6062



神钢/KOBELCO
SK135/130

YEM-H6063



神钢/KOBELCO
SK135/140-8

YEM-H6064



神钢/KOBELCO
SK200-6新款

YEM-H6065



神钢/KOBELCO
SK200-6老款

YEM-H6082



住友/SUMITOMO
SH400-3/SH450-3

YEM-H6083



住友/SUMITOMO
SH460-5

YEM-H6084



住友/SUMITOMO
SH460-5

YEM-H6085



杰西博/JCB
JS200

YEM-H6066



神钢/KOBELCO
SK200-8

YEM-H6067



神钢/KOBELCO
SK230-6E

YEM-H6068



神钢/KOBELCO
SK330-6(D3V112)

YEM-H6069



神钢/KOBELCO
SK330-6E(D5V140)

YEM-H6086



加藤/KATO
HD700-7/820-1/2/3

YEM-H6087



加藤/KATO
HD1023III/HD1430

YEM-H6088



加藤/KATO
HD2045

YEM-H6089



加藤/KATO
HD2045

YEM-H6070



神钢/KOBELCO
SK330-6E(D3V112)

YEM-H6071



神钢/KOBELCO
SK350-8

YEM-H6072



神钢/KOBELCO
SK450-6/6E

YEM-H6073



卡特/CARTER
CAT312

YEM-H6090



沃尔沃/VOLVO
EC210/240

YEM-H6091



沃尔沃/VOLVO
EC360

YEM-H6092



沃尔沃/VOLVO
EC460

YEM-H6093



沃尔沃/VOLVO
EC460

YEM-H6074



卡特/CARTER
CAT320C/320D

YEM-H6075



住友/SUMITOMO
SH130-5

YEM-H6076



住友/SUMITOMO
SH200-1

YEM-H6077



住友/SUMITOMO
SH200A3/SH300A3

YEM-H6094



三一/SANY
SY205/215

YEM-H6095



三一/SANY
SY205/215

YEM-H6096



三一/SANY
SY205/215/235

YEM-H6097

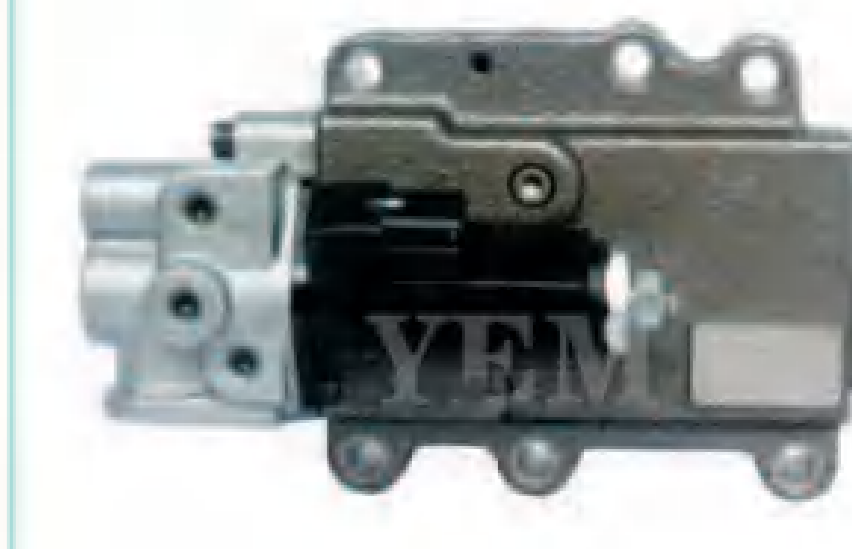

三一/SANY
SY235

YEM-H6078



住友/SUMITOMO
SH240-5

YEM-H6079



住友/SUMITOMO
SH240-5

YEM-H6080



住友/SUMITOMO
SH350-5/SH300-5

YEM-H6081



住友/SUMITOMO
SH350-5/SH300-5

YEM-H6098



三一/SANY
SY235

YEM-H6099



三一/SANY
SY335

YEM-H6100











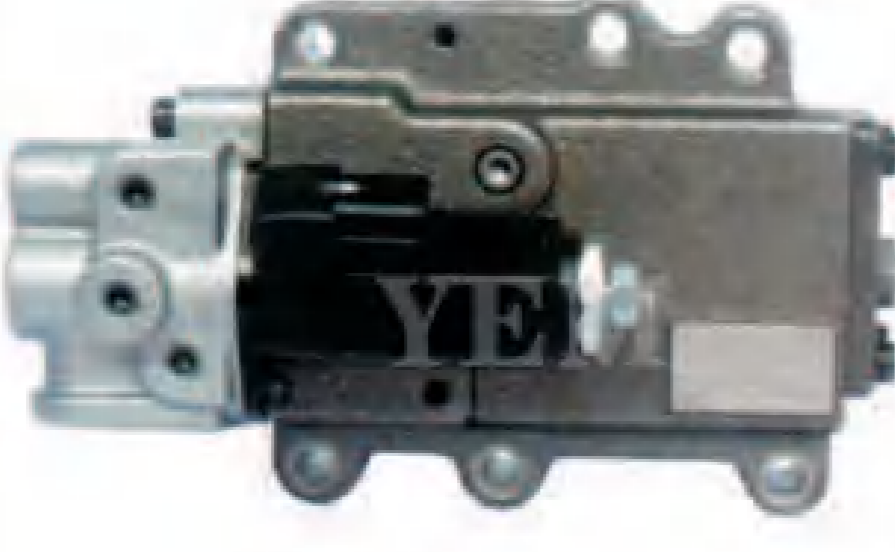





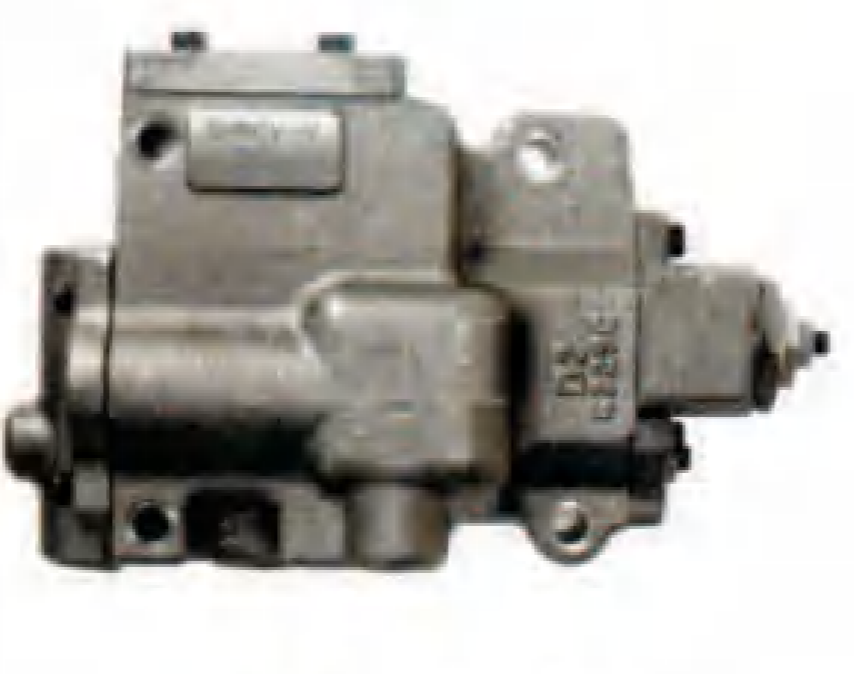
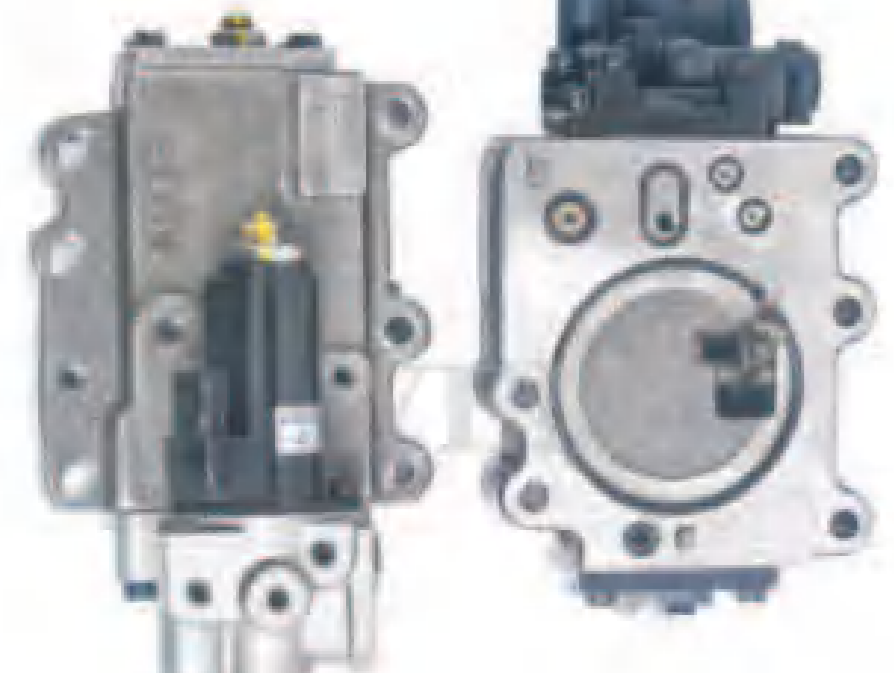
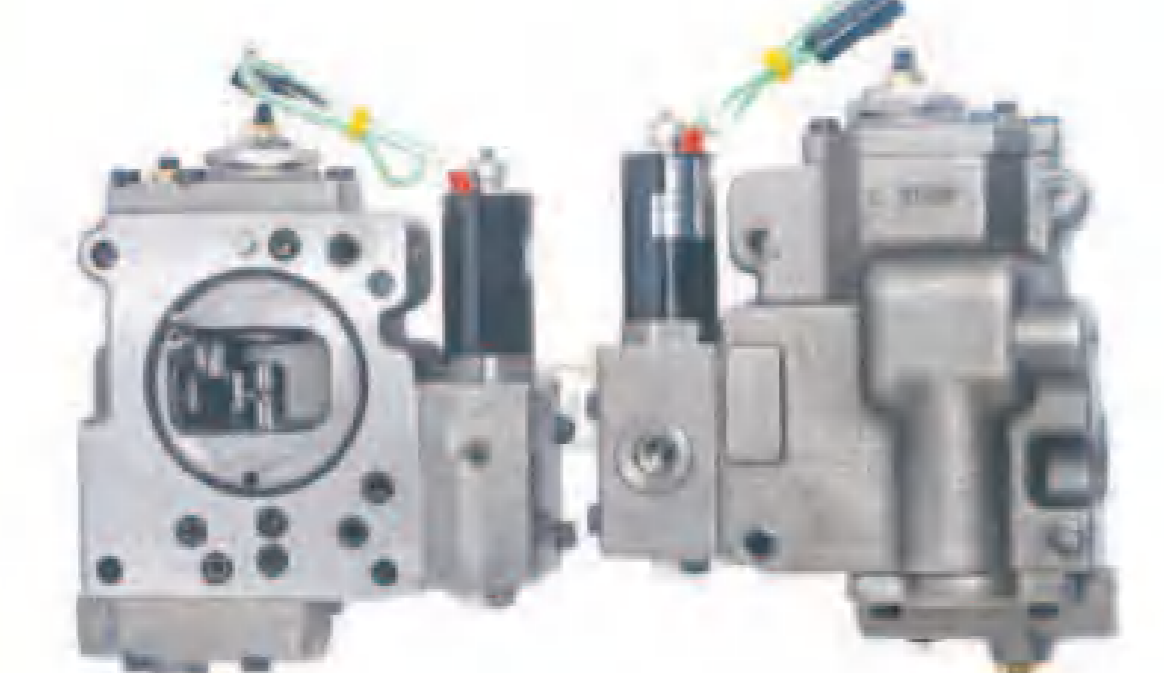
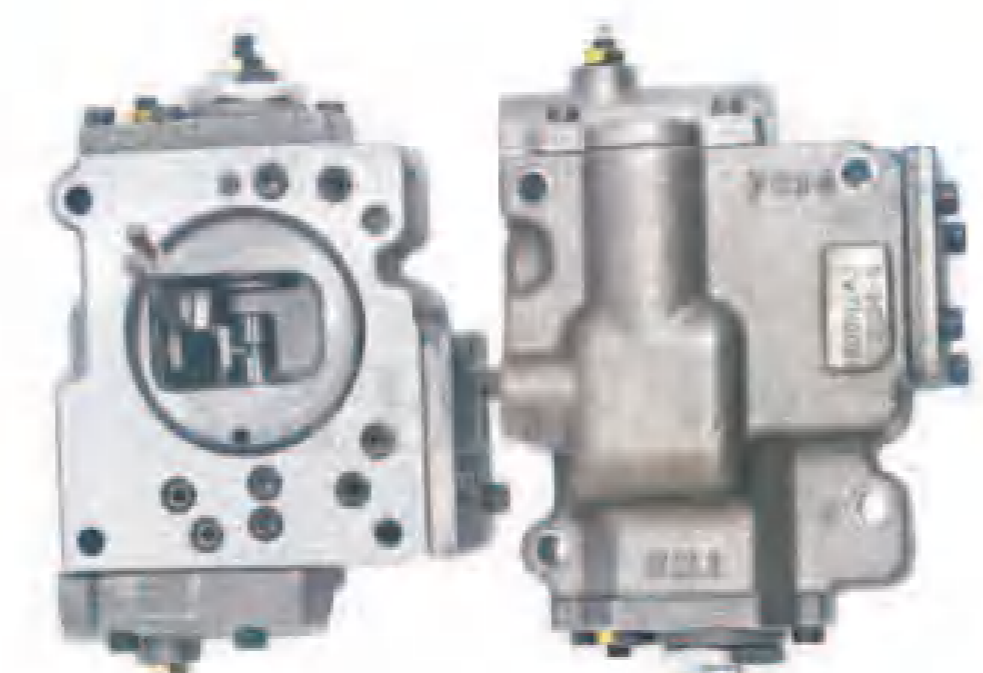

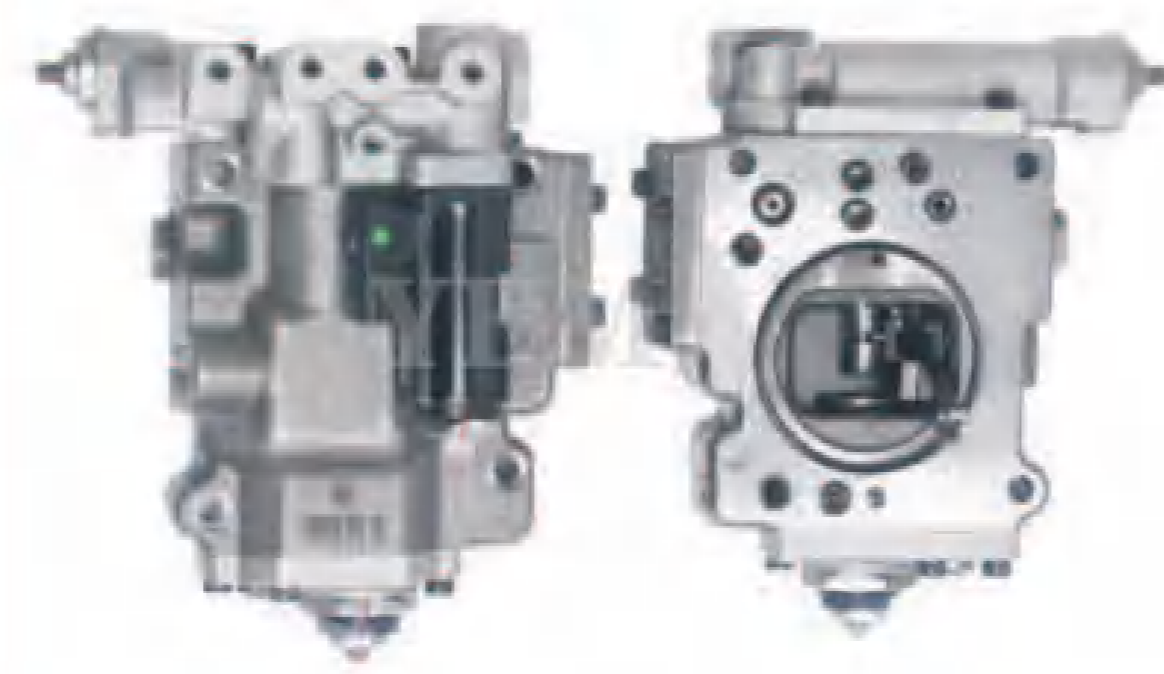

三一/SANY
SY335

YEM-H6101

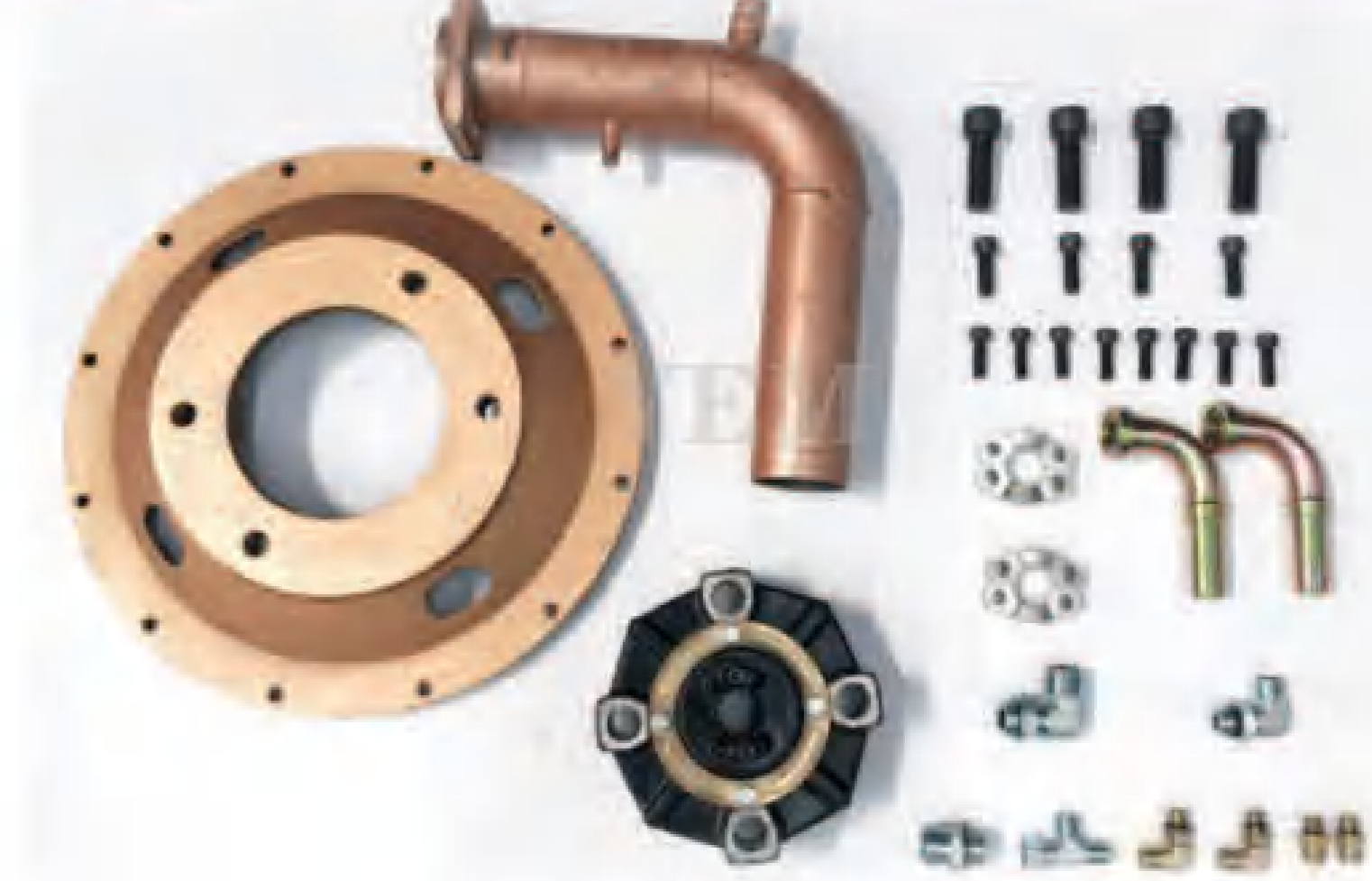

三一/SANY
SY335

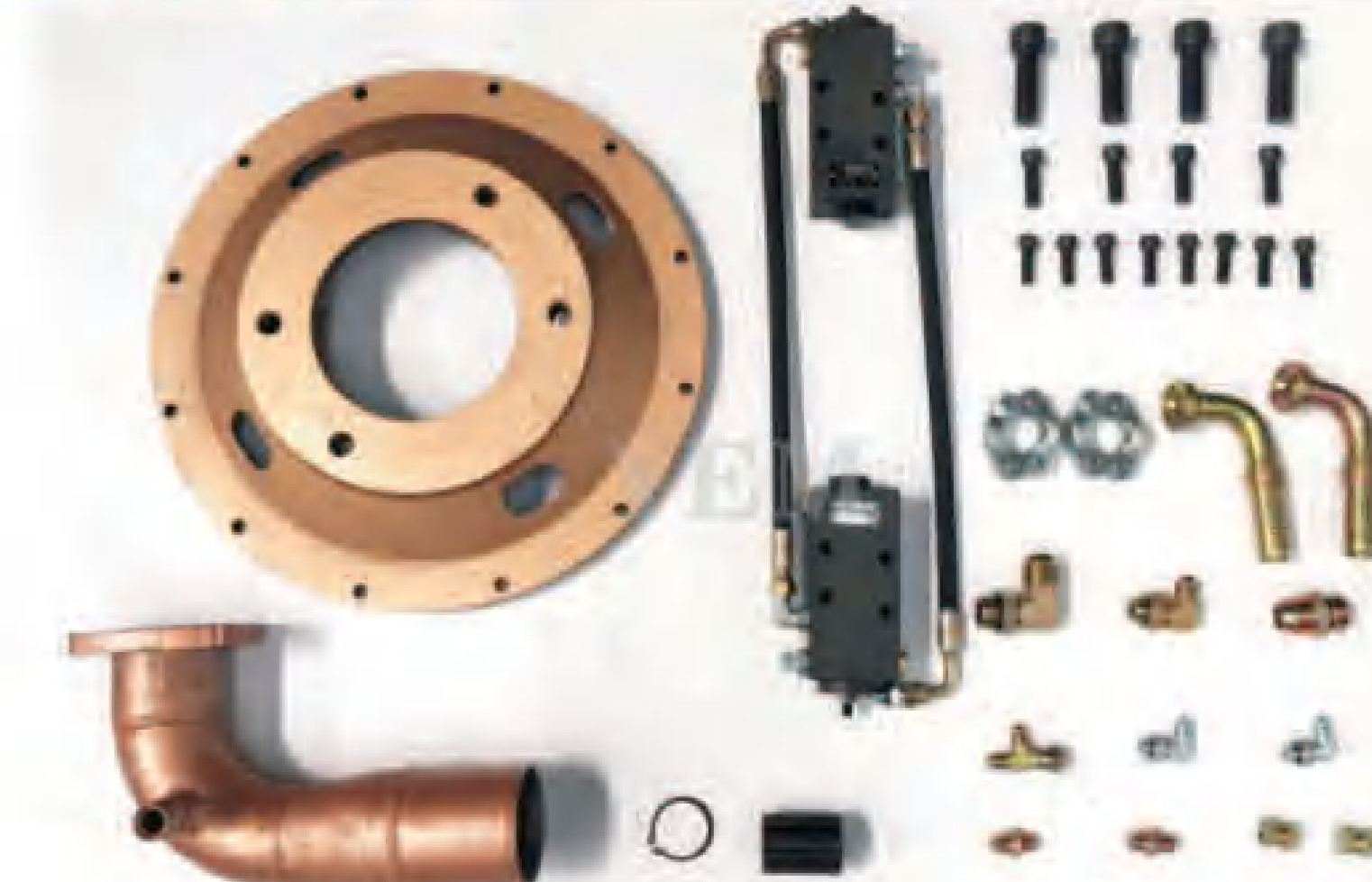
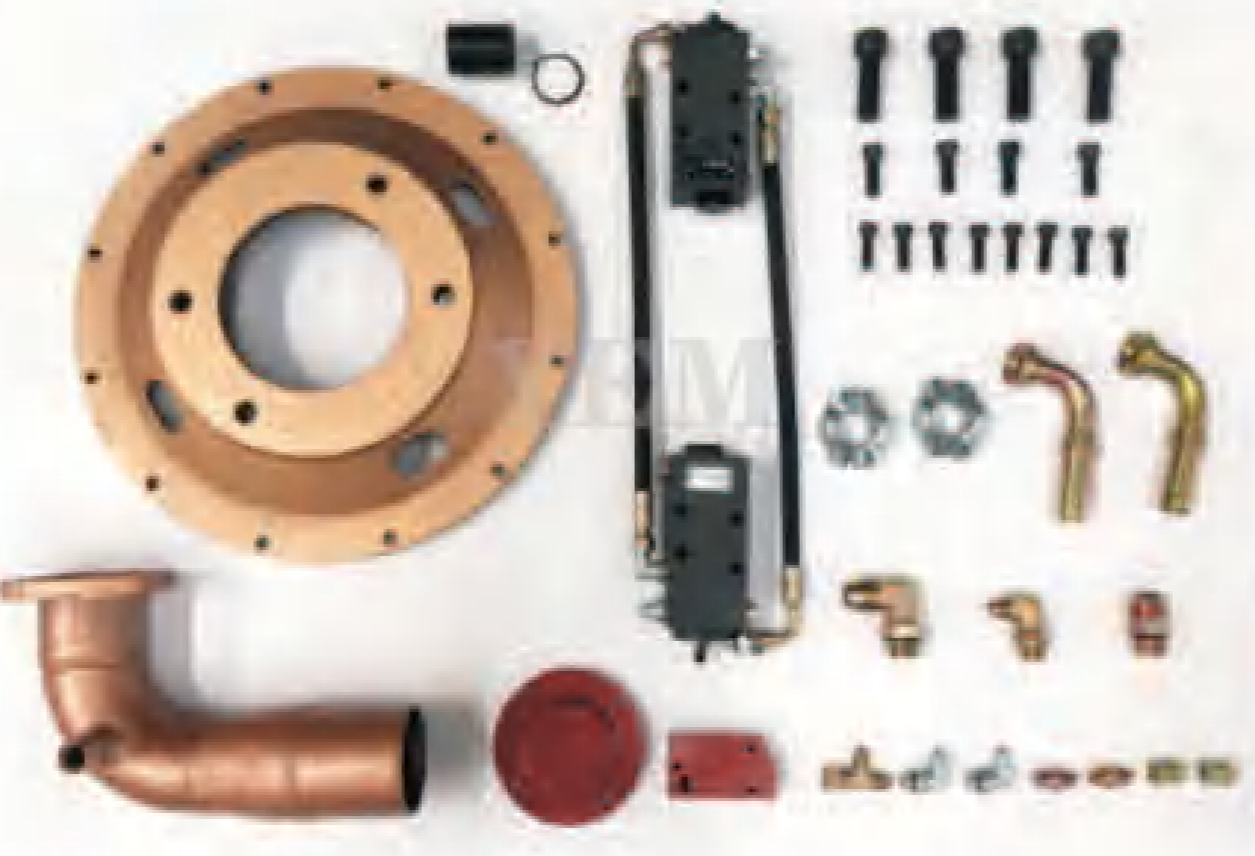
<p>YEM-H6102</p>  <p>三一/SANY SY330/360</p>	<p>YEM-H6103</p>  <p>日立/HITACHI ZX400-1/470-3</p>	<p>YEM-H6104</p>  <p>日立/HITACHI EX400-3/-5</p>	<p>YEM-H6105</p>  <p>柳工/LIUGONG 中联/ZOOMLION 30T</p>
<p>YEM-H6106</p>  <p>柳工/LIUGONG 徐工/XCMG 中联/ZOOMLION 山河/SUNWARD 厦工/SAHM 20T</p>	<p>YEM-H6107</p>  <p>现代/HYUNDAI R215-7</p>	<p>YEM-H6108</p>  <p>现代/HYUNDAI R225-7/R305LC-7</p>	<p>YEM-H6109</p>  <p>大宇/DAEWOO DH225-5</p>
<p>YEM-H6110</p>  <p>OE11</p>	<p>YEM-H6111</p>  <p>9C0S</p>	<p>YEM-H6112</p>  <p>9C112</p>	
<p>YEM-H6113</p>  <p>9N09</p>	<p>YEM-H6114</p>  <p>9P12</p>	<p>YEM-H6115</p>  <p>9T8L</p>	
<p>YEM-H6116</p>  <p>9TEL</p>	<p>YEM-H6117</p>  <p>HNOV</p>	<p>YEM-H6118</p>  <p>YT0K</p>	

<p>YEM-H6119</p>  <p>K3V180 CAT330B</p>	<p>YEM-H6120</p>  <p>K3V112 PC200-5</p>	
<p>YEM-H6121</p>  <p>K2V112 CAT320B/C</p>	<p>YEM-H6122</p>  <p>K3V112 E200B</p>	
<p>YEM-H6123</p>  <p>K3V180 ZAX330-6</p>	<p>YEM-H6124</p>  <p>K3V112 PC200-6</p>	
<p>YEM-H6125</p>  <p>K3V112 PC200-7/8</p>	<p>YEM-H6126</p>  <p>K3V180 PC360-7</p>	<p>YEM-H6127</p>  <p>K3V180 CAT330C</p>

行走马达总成 TRAVEL MOTOR ASSY

YEM—H6128



TM02总装外形图

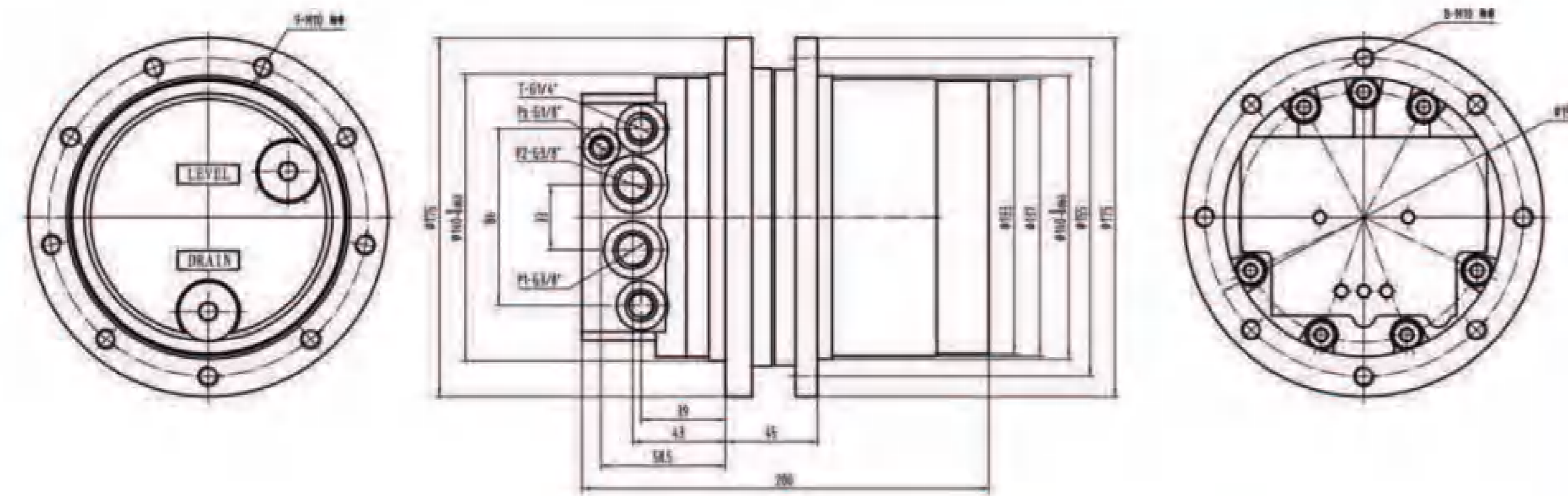

YEM—H6129



TM03总装外形图

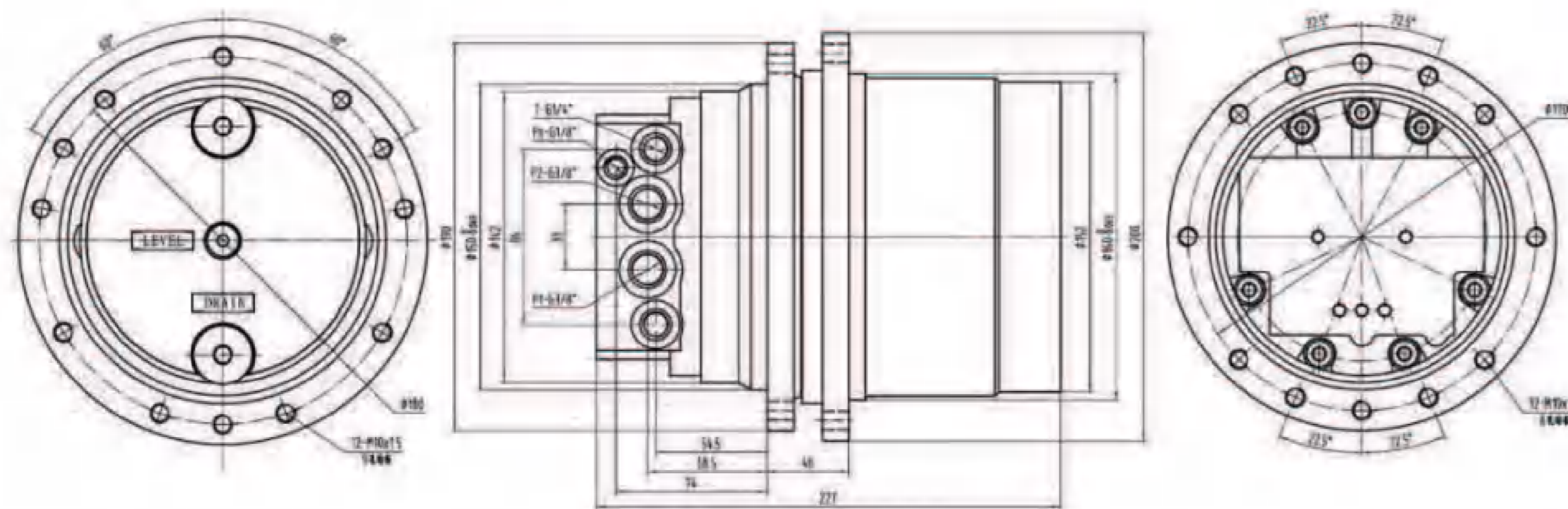

YEM—H6130



TM03A总装外形图

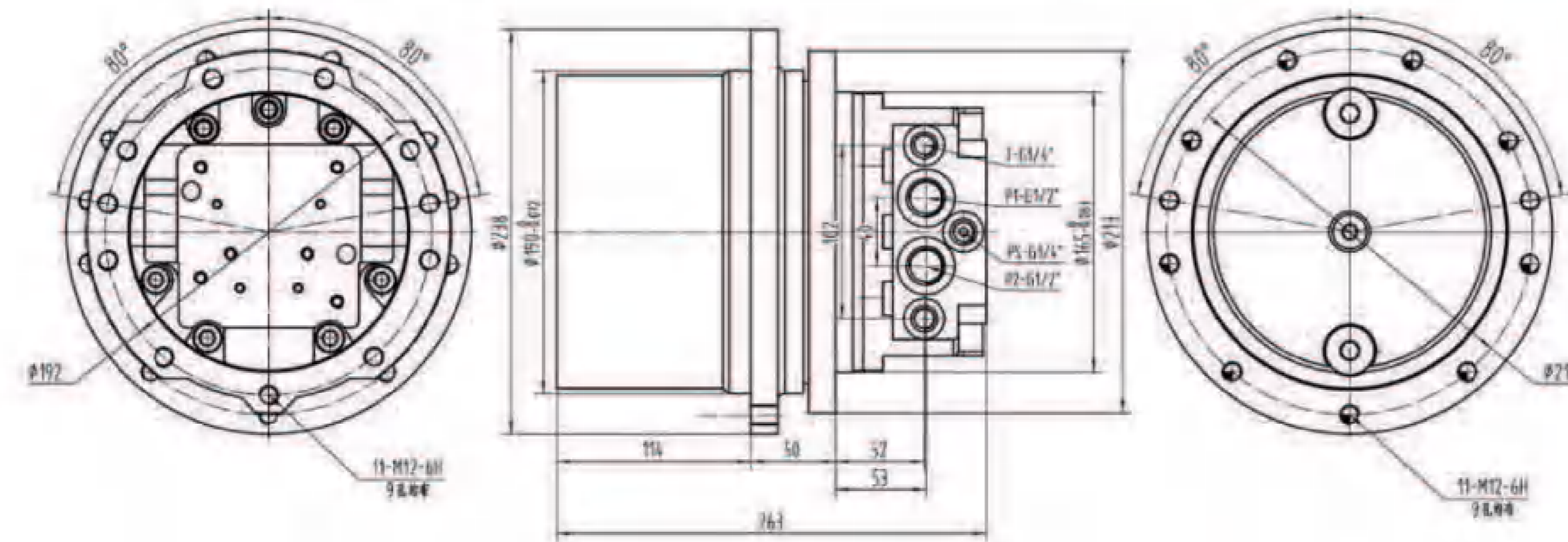

YEM—H6131



TM04 行走马达总成

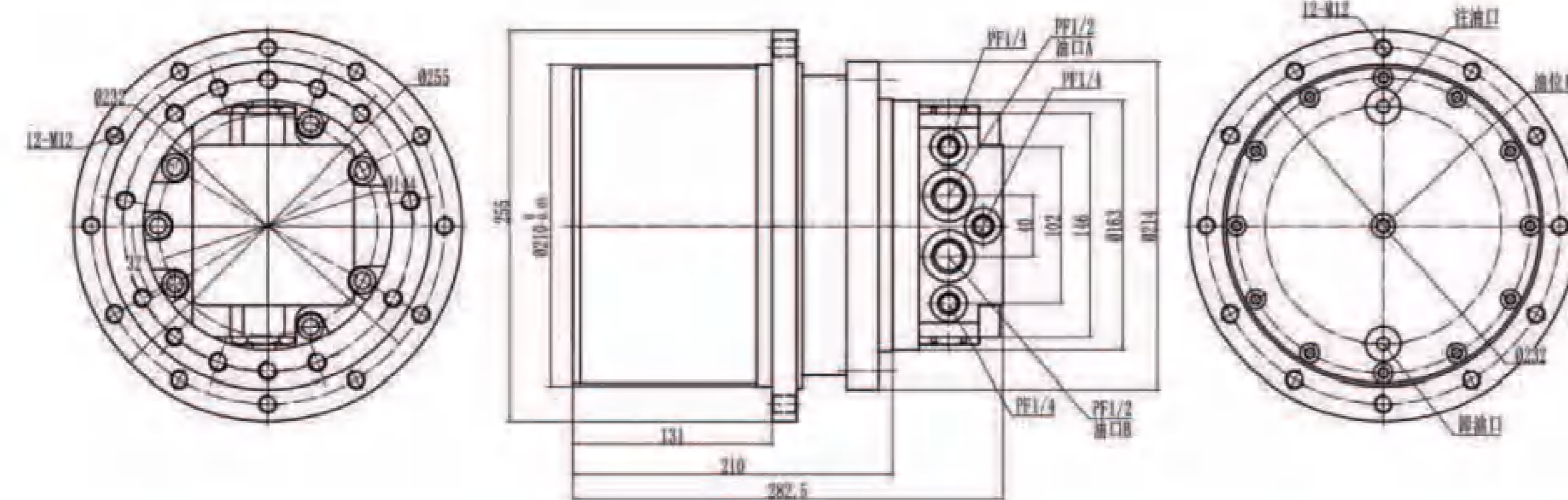

行走马达总成 TRAVEL MOTOR ASSY

YEM—H6132



TM04A(9孔)总装外形图

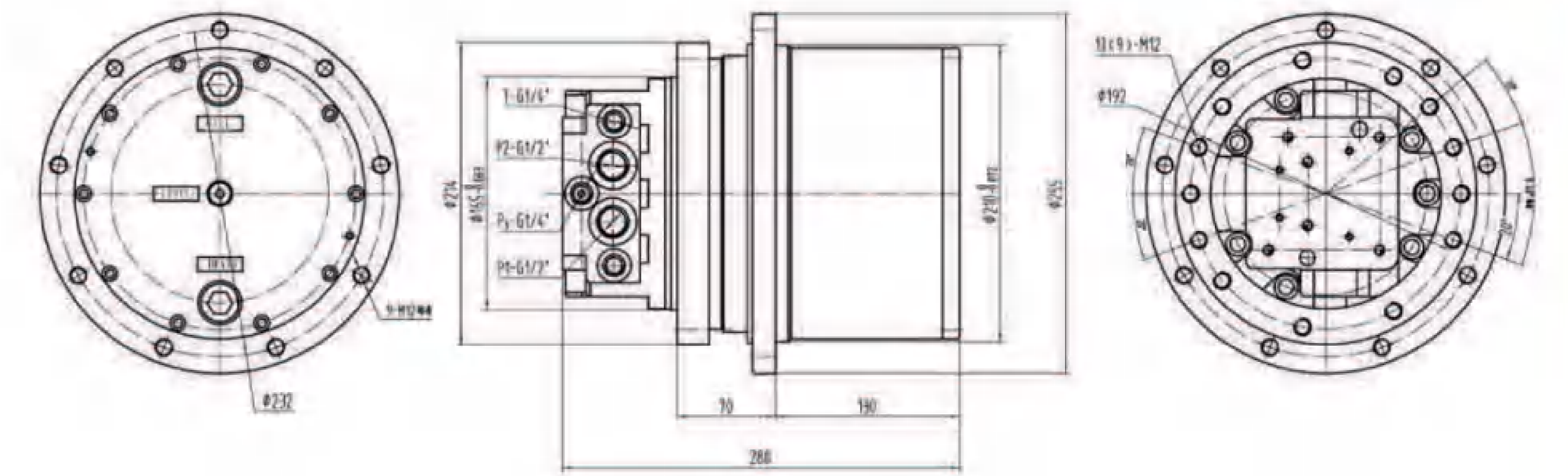

YEM—H6133



LTM04I外形安装图

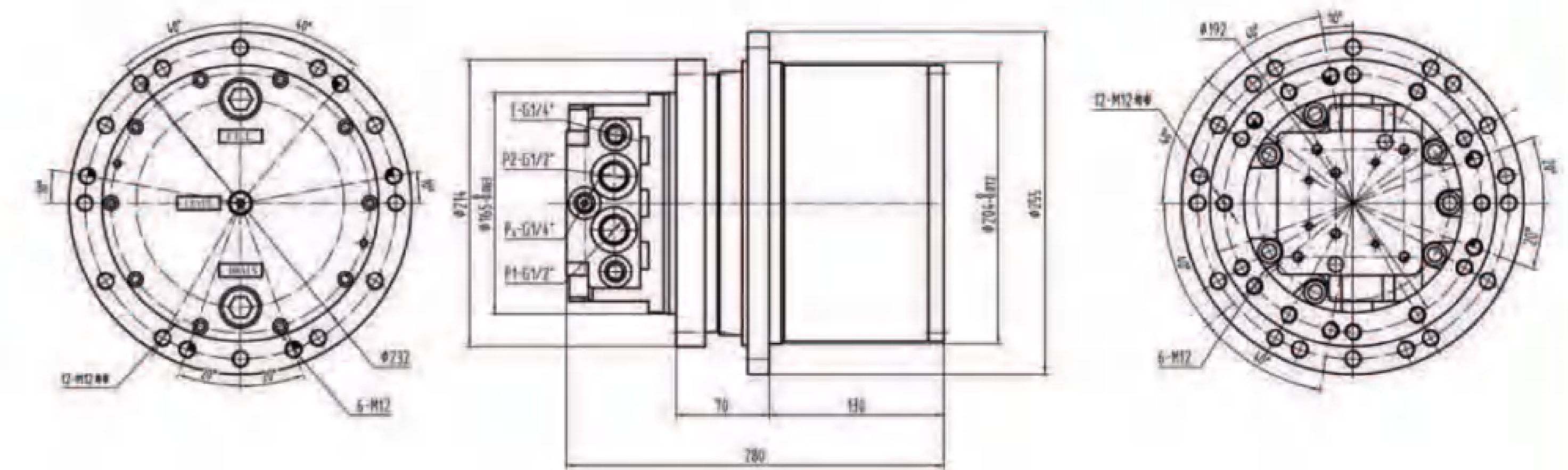

YEM—H6134



TM05总装外形图

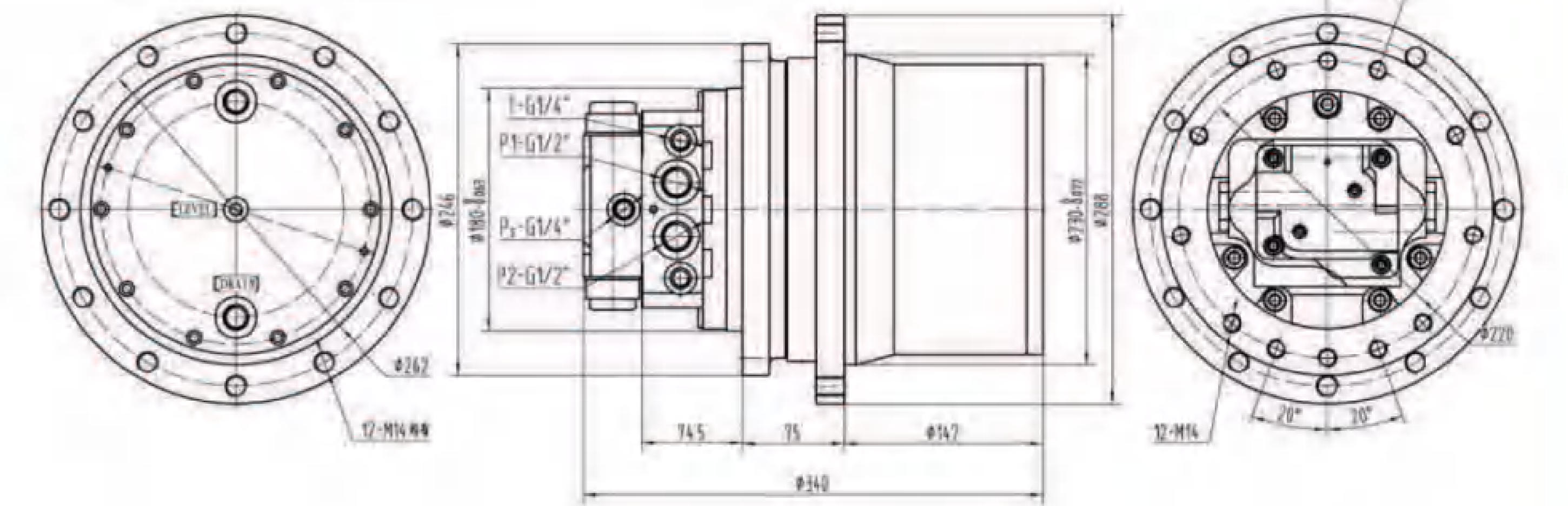

YEM—H6135



TM06 行走马达总成

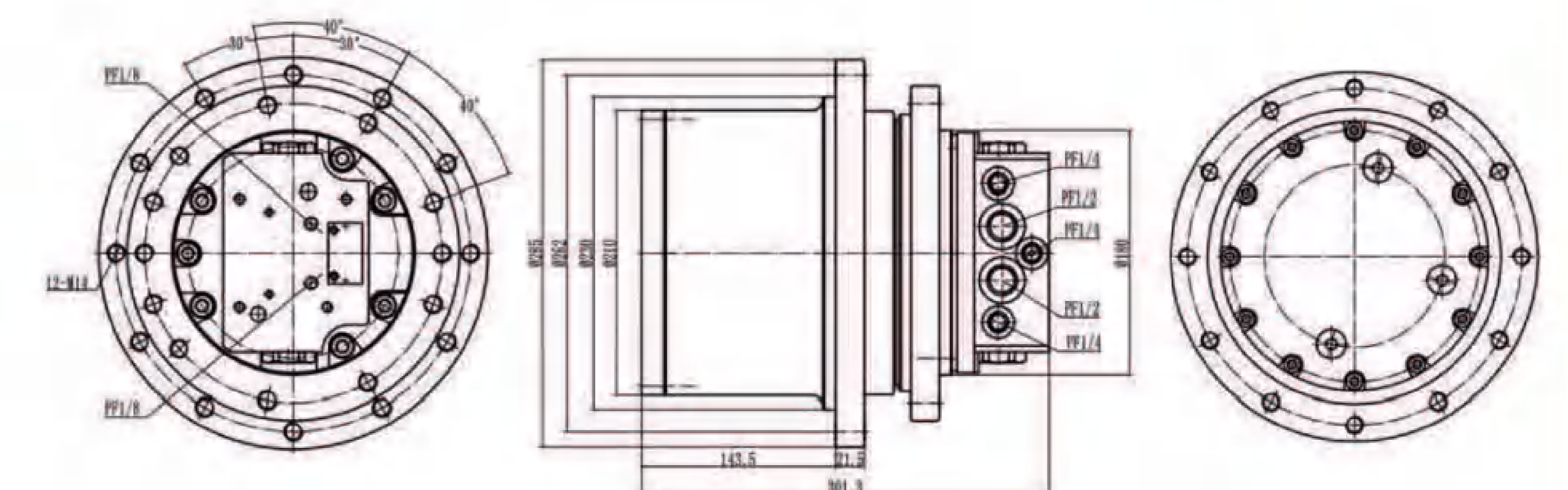

行走马达总成 TRAVEL MOTOR ASSY

YEM—H6136



TM06H总装外形图

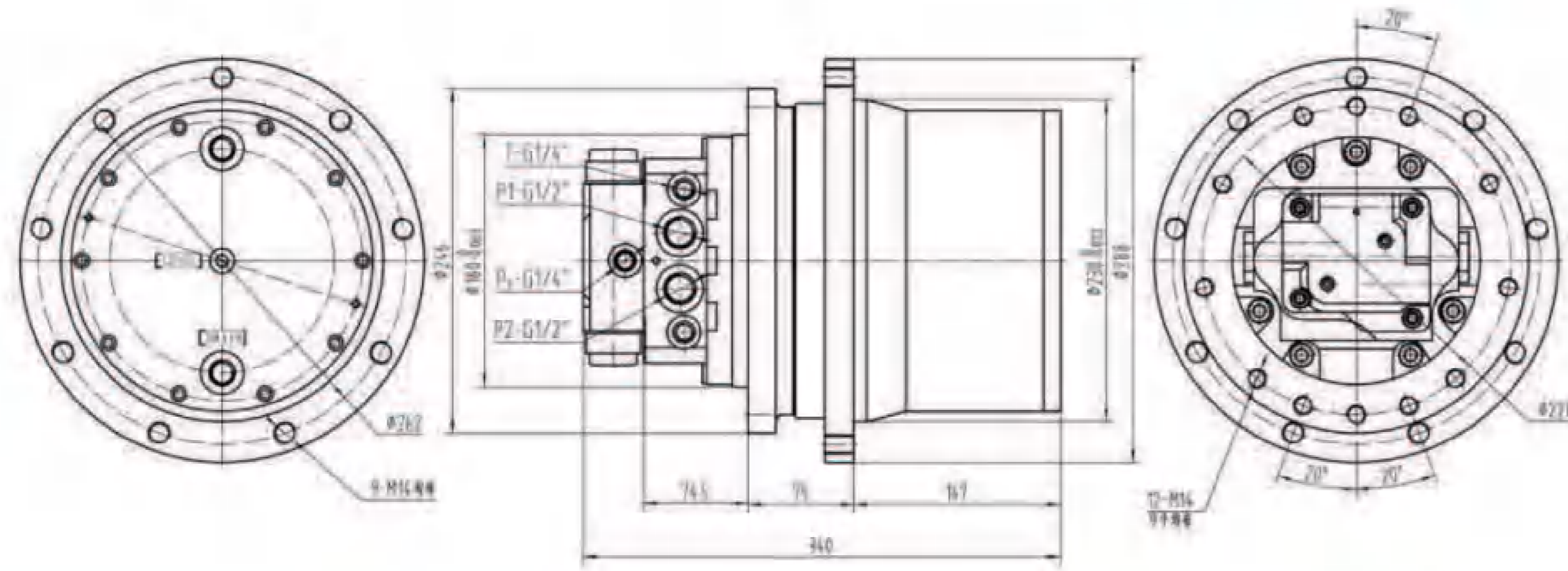

行走马达总成 TRAVEL MOTOR ASSY

YEM—H6140



TM18 行走马达总成

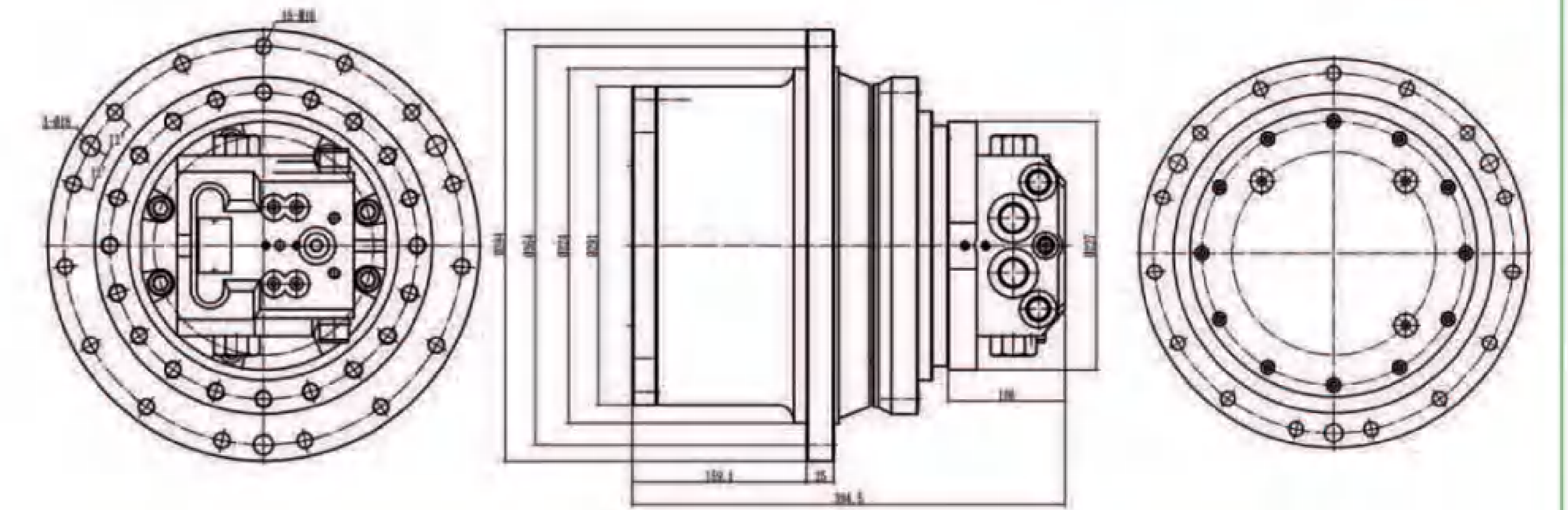

YEM—H6137



TM07B-MR总装外形图

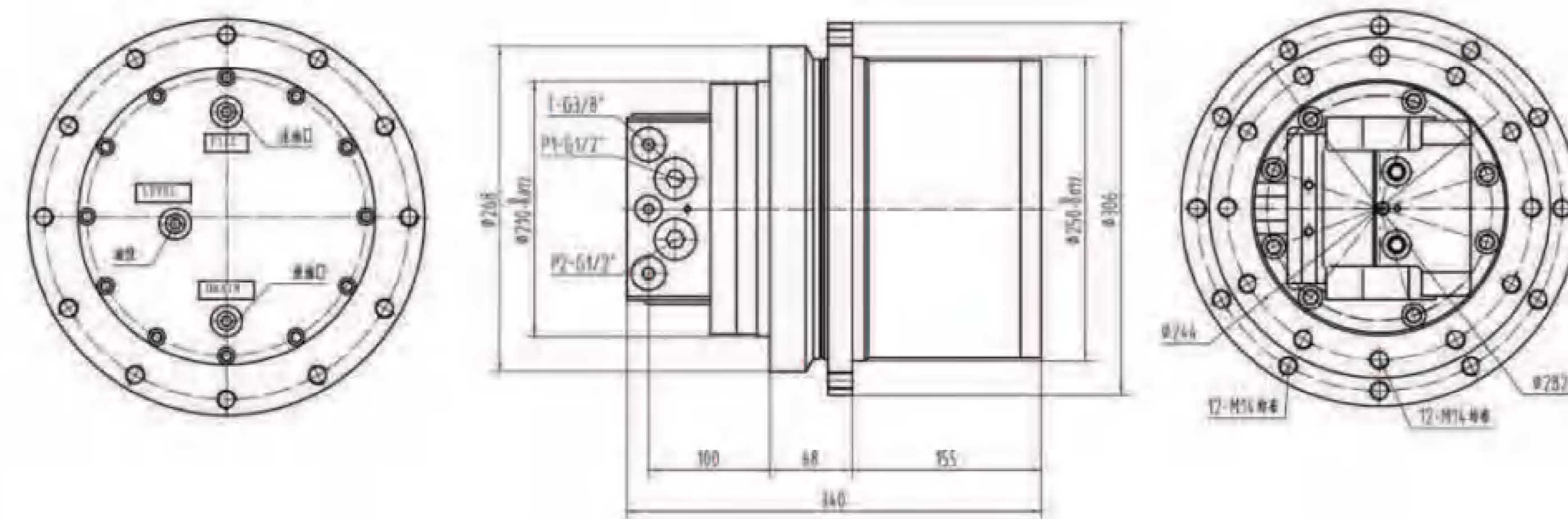

YEM—H6141



TM18B总装外形图

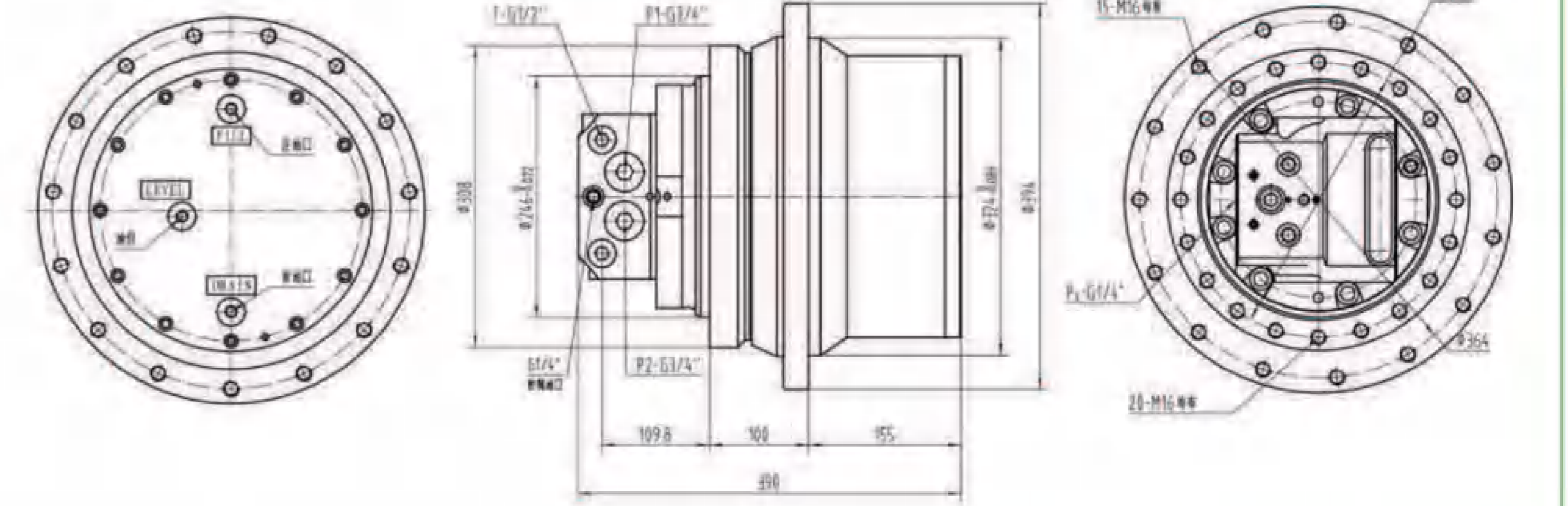

YEM—H6138



TM09 行走马达总成

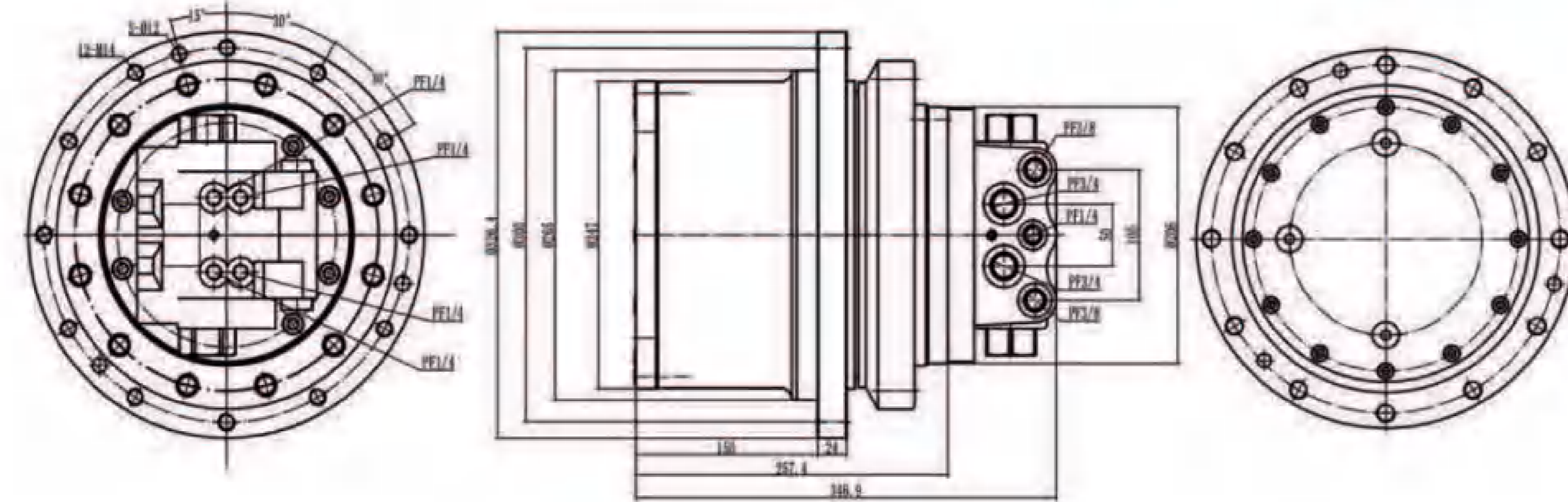

YEM—H6142



TM22总装外形图

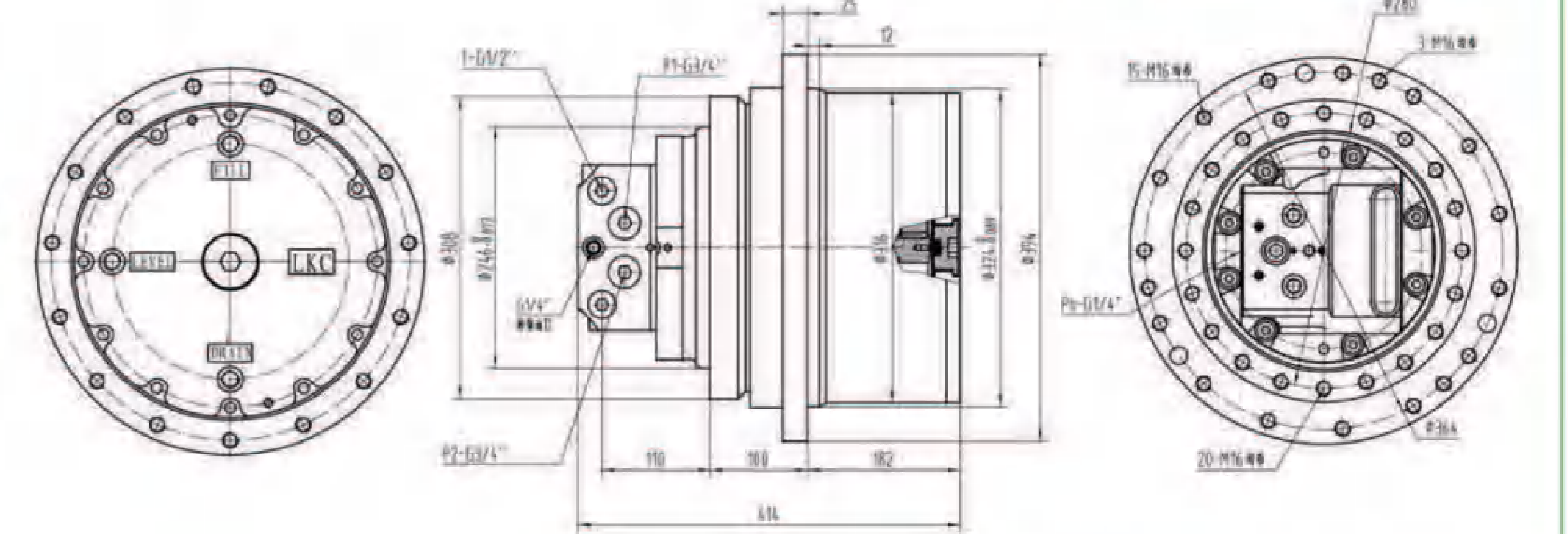

YEM—H6139



TM09C总装外形图

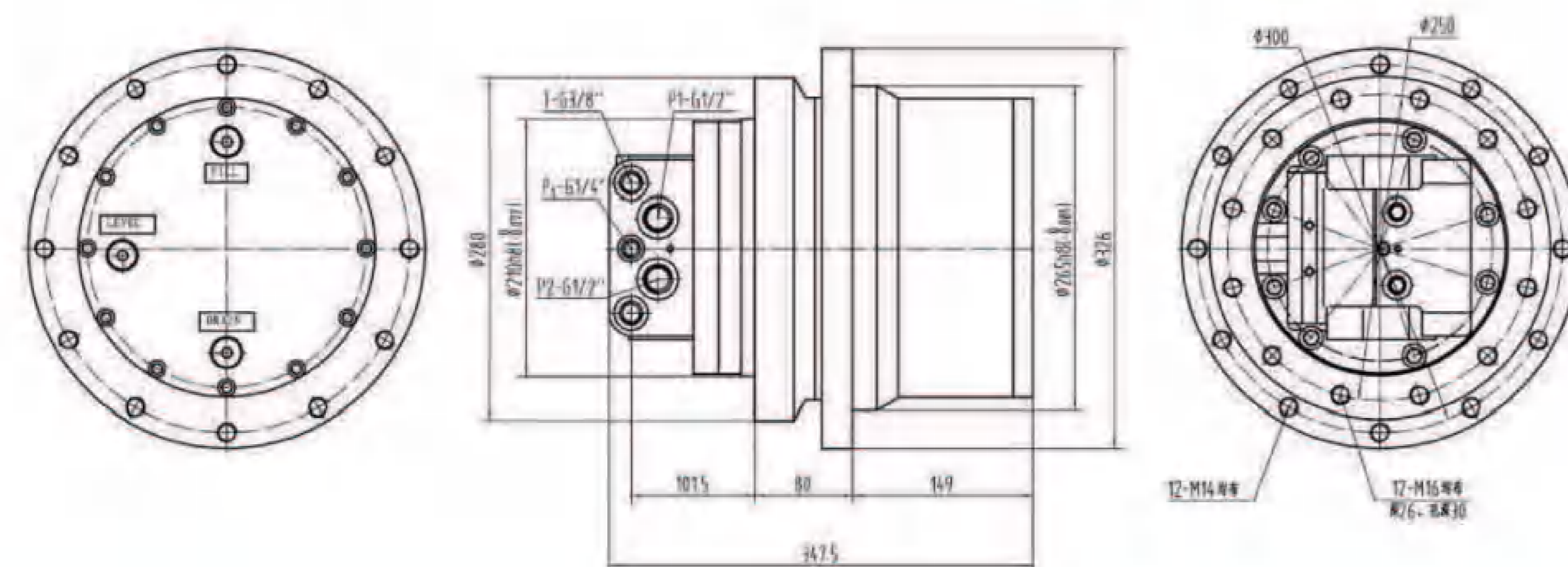

YEM—H6143



TM22C总装外形图

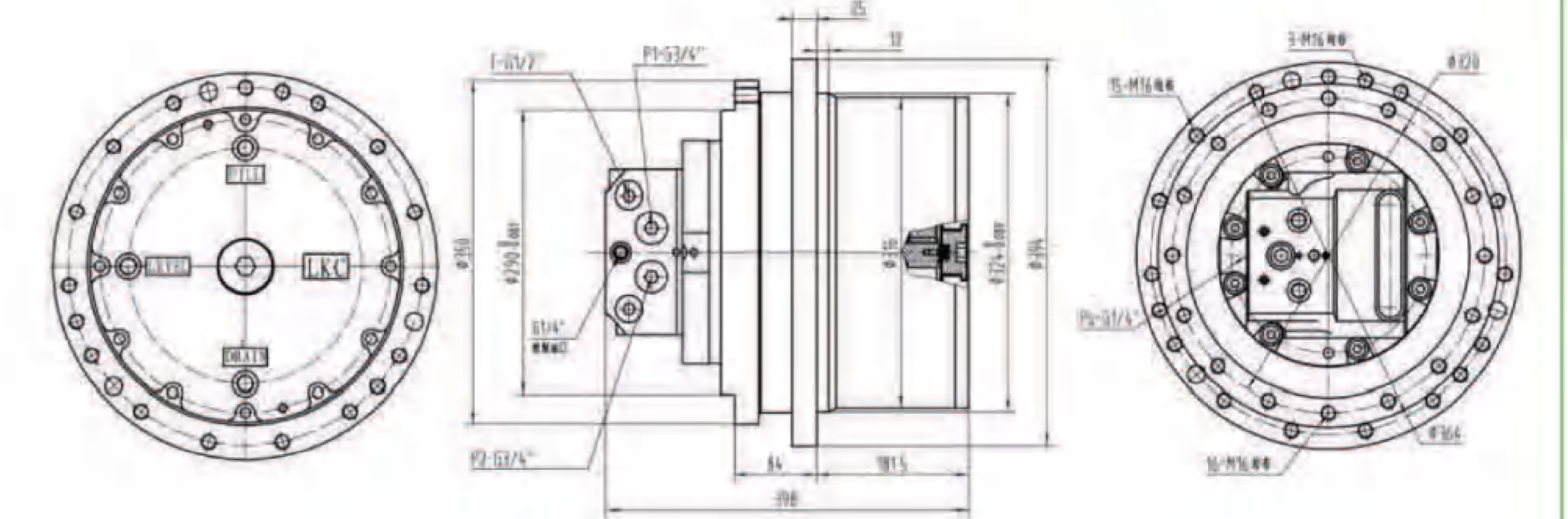

行走马达总成 TRAVEL MOTOR ASSY

行走马达总成通用表 TRAVEL MOTOR ASSY COMMON TABLE



MAG-170VP-3800
行走马达总成

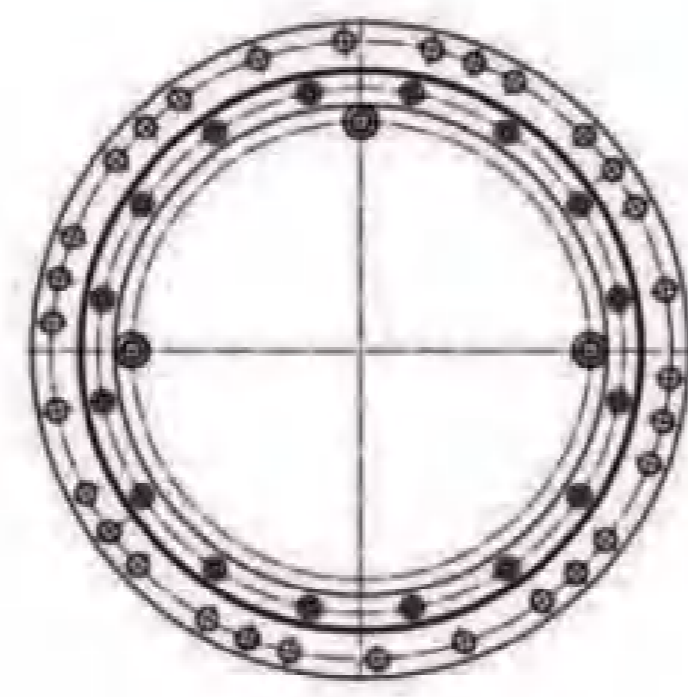
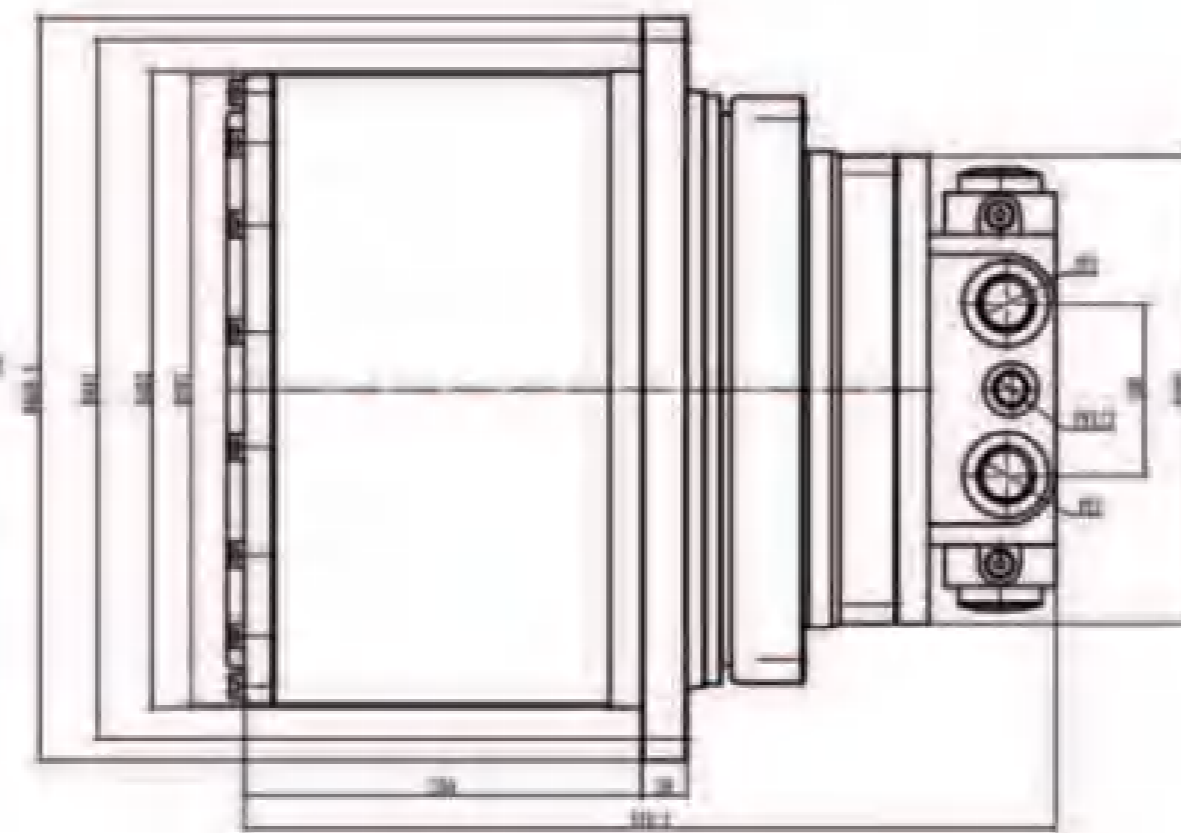
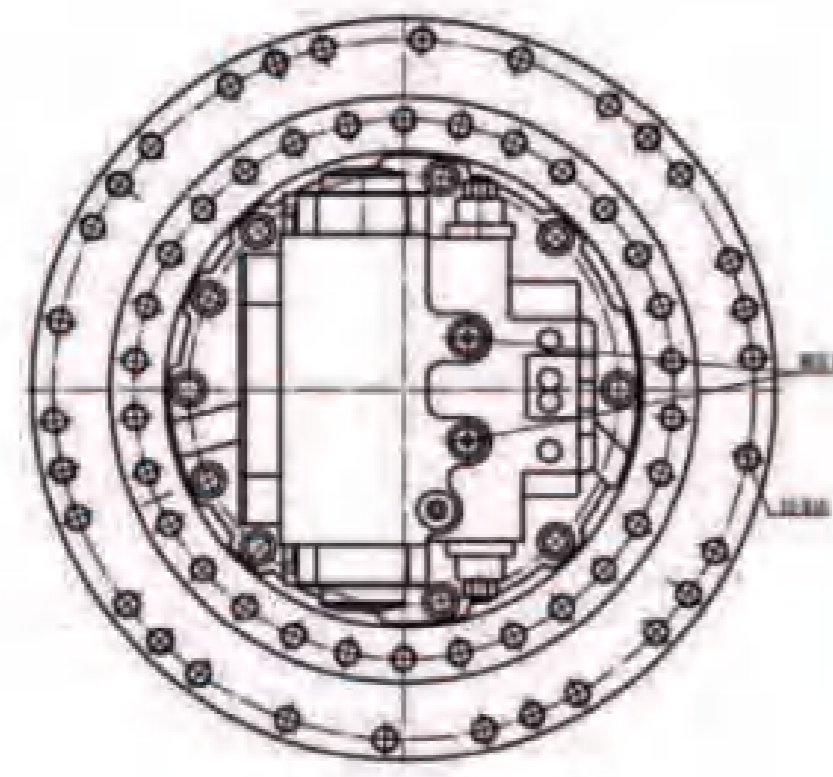

YEM-H6144



TM40 行走马达总成

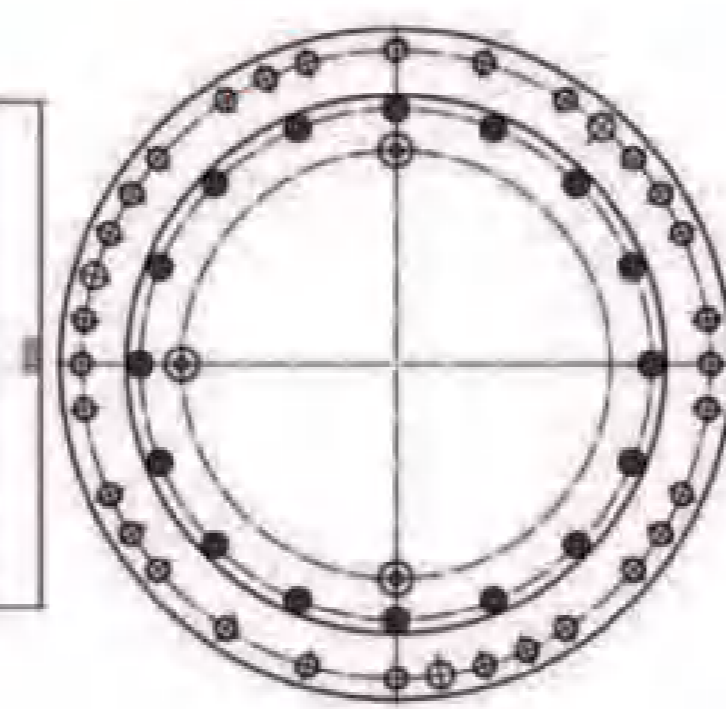
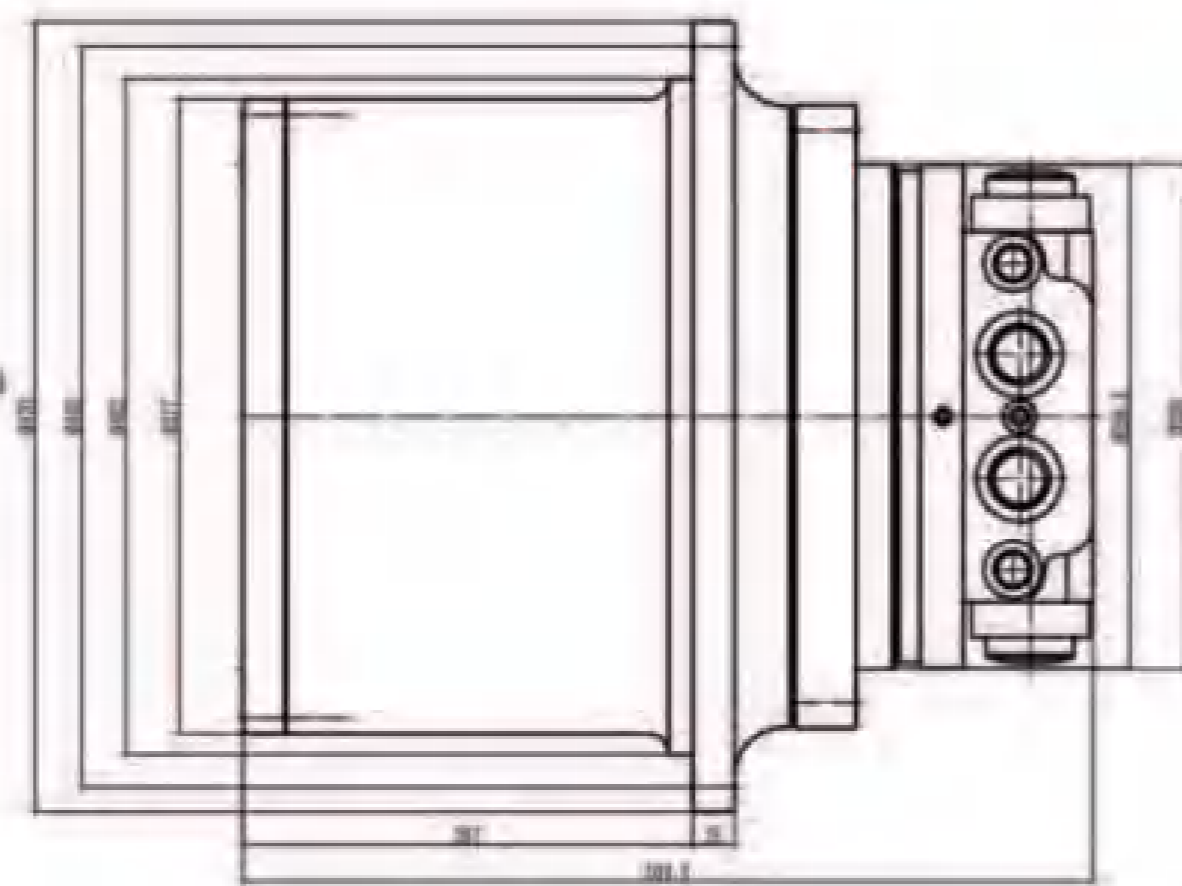
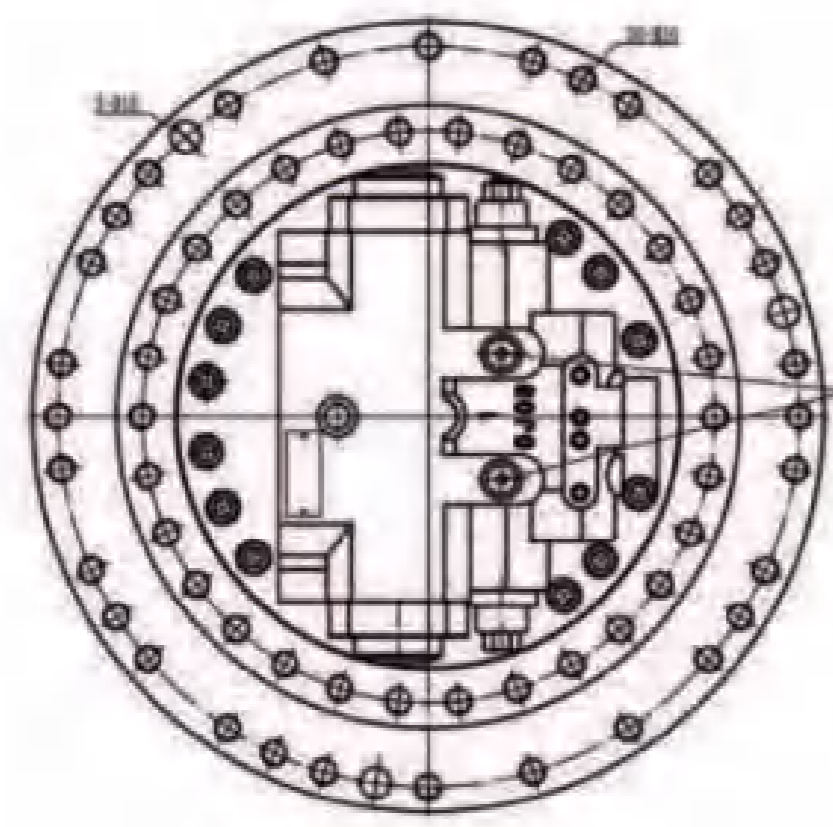

YEM-H6145



A
MAG-18VP-350F
行走马达总成



B
MAG33VP-550
山河70



C
E306



D
PC78

YEM-H6146



A
MAG85/三一135/卡特312



B
PC200-6/7



C
大宇220-5



D
SK200-6

YEM-H6147

KTM02 (6/12)(安装架孔 $\phi 10 \times 8$ 个, 齿盘孔 $\phi 10 \times 9$ 驱动齿内径140)适用车型1-1.8吨, 同不二越PHV-1B久保田15 神钢1.5玉柴18

Kubota久保田U 15-3
Komatsu小松PC 14R2
Case凯斯CX 18

Komatsu小松PC 15R8
New Holland纽荷兰E 18C
Kubota久保田K 008

Komatsu小松PC 07
Hitachi不二越ZX 18
Kubota久保田KX 41.2

Kubota久保田KX 41.2V
Kubota久保田KX 36.3
IHI Imer石川岛10 F2

KTM03(9.1/16.1)安装架 $\phi 10 \times 8$ 个, 齿盘孔 $\phi 10 \times 9$ 驱动齿内径160 · 适用车型: 2-2.8吨, 同不二越的PHV2B,KYB18VP-220

石川岛15 J
Yanmar洋马B 18EX
Volvo沃尔沃EC 20
Case凯斯CX 27B
Bobcat山猫X 225
Yanmar洋马B 17.2
Kubota久保田KX 61-3

Yanmar洋马VIO 25
Case凯斯CX 27
IHI Imer石川岛20 NX2
Case凯斯CX 22B
洋马B 19
Kubota久保田U 20
Yanmar洋马VIO 30

Kubota久保田U 25
Kubota久保田U 25.3
Kubota久保田U 25.3 alfa
Yanmar洋马B 19
Yanmar洋马VIO 20.2
洋马B 15
Pel JobEB 150

石川岛10 F2
洋马YB 121.2B
Yanmar洋马B 15
Takeuchi竹内TB 15
Yanmar 洋马B 19
小松 Pc20

KTM03A(9.1/16.1)安装架 $\phi 12 \times 9$ 个, 齿盘孔 $\phi 12 \times 9$ 驱动齿内径190 · 适用车型: 2.8-3.5吨, 同不二越的KYB18VP-230/350

Yanmar洋马B 22
Kubota久保田KX 71-2
Hitachi不二越EX 35
IHI Imer石川岛28 N
Bobcat山猫325
Yanmar洋马B 25V
Kubota久保田KX 71-3

Kubota久保田KX 61-2
Yanmar洋马B 37V
Hitachi不二越ZX 30 CLR
Libra利勃海尔224 S
Hitachi不二越FH 35.2
Hitachi不二越EX 30.2
Hitachi不二越FH 22.2

Volvo沃尔沃EC 25
Kubota久保田KX 71
IHI Imer石川岛25 VX
Case凯斯CK 25
Yanmar洋马B 27
Yanmar洋马VIO 30
Kubota久保田KX 61

IHI Imer石川岛25 NX
JCB802.7
Takeuchi竹内TB 125
Kubota久保田U 25-3 (ver. B)
IHI Imer石川岛30 NX
Yanmar洋马B 22
Kubota久保田KX 91.3
小松 PC 30

KTM04(14/24)(安装架孔 $\phi 12 \times 9$ 个, 齿盘孔 $\phi 12 \times 12$ 驱动齿内径210)适用车型3-4吨, 同不二越PHV-390-53B日立40

KTM04A (14/24)(安装架孔 $\phi 12 \times 9$ 个, 齿盘孔 $\phi 12 \times 9$ 驱动齿内径210)适用车型3-4吨, 同KYBMAG26VP神钢40 (驱动齿204)

小松30、35
Yanmar 洋马B 37
Bobcat 山猫331 D

Caterpillar卡特彼勒303.5
Neuson 威克诺森2902 RD
Hitachi不二越EX 35

Neuson 威克诺森2702 RD
IHI Imer石川岛35 J
Bobcat山猫328 DCC

竹内TB035
Komatsu 小松PC 40.6
Pel JobEB 406

KTM04I (14/24)(安装架孔 $\phi 12 \times 9/12$ 个, 齿盘孔 $\phi 12 \times 9/12$ 驱动齿内径204)适用车型3-4吨,神钢40 (驱动齿204)

Bobcat 山猫331 D
Bobcat 山猫425
Kubota久保田KX 101

Hitachi 不二越EX 40
IHI Imer石川岛25 J
Kubota久保田U 30

Volvo沃尔沃EC 30
Kubota久保田KX 91.2
凯斯CX 36

KTM05(14/24)(安装架孔 $\phi 14 \times 9$ 个, 齿盘孔 $\phi 14 \times 12$ 个驱动齿内径230)适用于4-5。小松45

KTM06(19/34)(安装架孔 $\phi 14 \times 9$ 个, 齿盘孔 $\phi 14 \times 12$ 个驱动齿内径230)适用车型5-6吨。同纳博GM06VA,不二越的PHV-4B-60B

小松50, 56 卡特305.5 卡特305 (9*9配凹驱动齿) 玉柴60-8 ZX60(同KYB MAG-33VP-550F-9)

KTM06H(19/34)(安装架孔 $\phi 14 \times 9$ 个, 齿盘孔 $\phi 14 \times 9$ 个驱动齿内径230)

小松45 + 50 卡特305.5 等石川岛45NX + 40NX2 大宇55 沃尔沃45

KTM06K(19/34)(安装架孔 $\phi 12 \times 9$ 个, 齿盘孔 $\phi 12 \times 9$ 个驱动齿内径230)适用车型: 雷沃65-8威克诺森6002

KTM06F(19/34)(安装架孔 $\phi 12 \times 9$ 个, 齿盘孔 $\phi 12 \times 9$ 个驱动齿内径230)此款仿KYB(MAG-33VP-550F-10) 雷沃60 山河智能70、60

行走马达总成通用表 TRAVEL MOTOR ASSY COMMON TABLE

KTM07(22/44) (安装架螺孔直径 $\phi 14 \times 12$ 个, 齿盘直径 $\phi 14 \times 12$ 个驱动齿内径250) 适用车型: 5.5-6.5T

替代: 第一油压: JMV41	三一: SY65C-9, SY60C-9	犀牛: XN60-9, XN60-4L	嘉和: JH70
第星: 6TM442201-R	神钢60-C,60(11孔)	厦工: 806	现代: R55,R60J
斗山: TM07VC-A-19;	北车8060	熔盛: ZY70凯斯55(11孔)	开元-60-7
纳博特斯克: GM07VC;	徐工: XE60, 60CA	临工: LG660, LG665	众友906D
斗山: DH60-7, DX60W, DH55, DH70	山河50N9	沃尔沃55	沃得60-7, 65E-8

KTM09(34/53)安装孔为 (安装架螺孔直径 $\phi 16 \times 12$ 个, 齿盘直径 $\phi 14 \times 12$ 个) 驱动齿内径265适用车型: 6T-8.5T
代替斗山: TM10VD-A-26/49-1;第星: 7TM,8TM53310147;第一油压: JMV-47/27-01-VBC-RJ-53

纳博特斯克:GM10VL,GM09VN;KYB:MAG-44VP-800	钢: SK60, SK70	山东卡特: 85,80沃得85B-8
小松PC60/5.16./7/8, PC80/5/6/7/8;	山河智能: SWE85	振宇70-8
加藤250、307	厦工80,808	众友907B
卡特CAT70B, 308, 307	雷沃85-7, 80-7	詹阳85-7
斗山DH80GOLD	柳工908D,910D	久保田KX080-3
现代R80(TM09F)	开元85-766	竹内TB070
三一: SY95C-9, SY75C-9	沃尔沃ECR88	竹内TB180FR
临工: LG685, LG690E	玉柴: 85-3/-5	洋马B7
犀牛: XN75-9	石川岛 60	威克诺森75z3 RD
住友: 60神	徐挖: G88-7-8	

KM18(43/67)·安装孔 (安装架螺孔直径 $\phi 16 \times 20$ 个, 齿盘安装孔直径 $\phi 16 \times 15$ 个) 适配车型: 10T-13T同:

第星 (JEIL) 14TM; 纳博特斯克GM18VL,斗山TM18VC,	雷沃130
小松PC120, PC100, PC130,PC128UU,PC110-7	斗山100,120
山重 913	玉柴135u
加藤510 512, 512R	众友912,913
住友SH120	力士德130
神钢SK100, SK120	柳工120.130

KTM22(54/82) (安装架螺孔直径 $\phi 16 \times 20$ 个, 齿盘直径 $\phi 16 \times 15$ 个) 驱动齿内径324适用车型: 卡特312
替换: 斗山TM22VC;第一油压JMV-76/45-01-VBC-RJ-54, 纳博GM21VC

小松PC135, PC150	加藤: 450	临工: LG6150E	玉柴YC135, YC160-8
斗山DH135, DH150	三一: SY155C-9	厦工: XG815E	*柳工135,150
神钢130,140	徐工: XE150D	山河智能: SWE150LC	

KTM22C(54/82) (安装架螺孔直径 $\phi 16 \times 16$ 个, 齿盘直径 $\phi 16 \times 15$ 个) 驱动齿内径324同KYBMAG-85VP-1800
适用车型: 卡特311, 312B/C/D 三一135现代110住友265

TM40(95/147)安装架孔 $\phi 16 \times 30$ 个, 齿盘孔 $\phi 16 \times 22+8$ 个驱动齿内径402 适用车型18-25吨

徐工215C	雷沃220	中联215	柳工200
厦工822,325,825, 822DL(22孔)	沃得220	现代215, 225	沃尔沃 216
神钢260,270	斗山220	加藤800-7	

YEM 广州复格
Guangzhou Fuge

PART NO: KTM06VA
SERIAL NO: JJ-1258

DOOSAN

PART NO: MBEZ
SERIAL NO:
DOOSAN MOTTROU CO., LTD.

S.K.F
Genuine Parts

TYPE
USE FOR
NO.
GUANG LI
HEAVY MACHINERY PARTS

NOTONO

PART NO:
SERIAL NO:
GUANG LI
HEAVY MACHINERY PARTS

行走牙箱 WALKING TOOTH BOX

YEM-H6148



19X28(新)行走

YEM-H6149



20X28(老)行走

YEM-H6150



DH60-7行走

YEM-H6151



DH80G行走

YEM-H6152



DH220-5行走

YEM-H6153



DH225-9行走

YEM-H6154



DH258-7行走

YEM-H6155



DH300-7行走

YEM-H6156



DH370行走

YEM-H6157



DX300-7行走

YEM-H6158



E305行走

YEM-H6159



E312行走

行走牙箱 WALKING TOOTH BOX

行走牙箱 WALKING TOOTH BOX

YEM-H6160



E320C行走

YEM-H6161



EC140行走

YEM-H6162



EC240行走

YEM-H6172



Pc78行走

YEM-H6173



PC120-5行走

YEM-H6174



PC120-6行走

YEM-H6163



EC290行走

YEM-H6164



EC360行走

YEM-H6165



EX120-1行走

YEM-H6175



PC200-6行走

YEM-H6176



PC200-7行走

YEM-H6177



PC200-8行走

YEM-H6166



EX200-1行走

YEM-H6167



EX200-5行走

YEM-H6168



EX300-5行走

YEM-H6178



PC360-7行走

YEM-H6179



R60-5行走

YEM-H6180



R60-7行走

YEM-H6169



PC56行走

YEM-H6170



PC60-6行走

YEM-H6171



PC60-7行走

YEM-H6181



R80-7行走

YEM-H6182



R110-7行走

YEM-H6183



R150-9行走

行走牙箱 WALKING TOOTH BOX

YEM-H6184



R225-9行走

YEM-H6185



R305-7行走

YEM-H6186



R375-7行走

YEM-H6196



YC60-8行走

YEM-H6197



ZAX60行走

YEM-H6198



ZAX120行走

YEM-H6187



SH200A3行走

YEM-H6188



SH200行走

YEM-H6189



SH265行走

YEM-H6199



ZAX200(双)行走

YEM-H6200



ZAX200-3行走

YEM-H6201



ZAX230(单)

YEM-H6190



SK140-8行走

YEM-H6191



SK200-6行走

YEM-H6192



SK200-8行走

YEM-H6202



ZAX230(双)行走

YEM-H6203



ZAX240-3行走

YEM-H6204



ZAX330-1行走

YEM-H6193



SK230-6行走

YEM-H6194



SK350-8行走

YEM-H6195



TM18(半)行走

YEM-H6205



ZAX330-3行走

YEM-H6206



力士乐60行走

YEM-H6207



山河70行走

行走牙箱 WALKING TOOTH BOX

行走马达盖 TRAVELLING MOTOR COVER

回转马达总成 ROTATE MOTOR ASSY

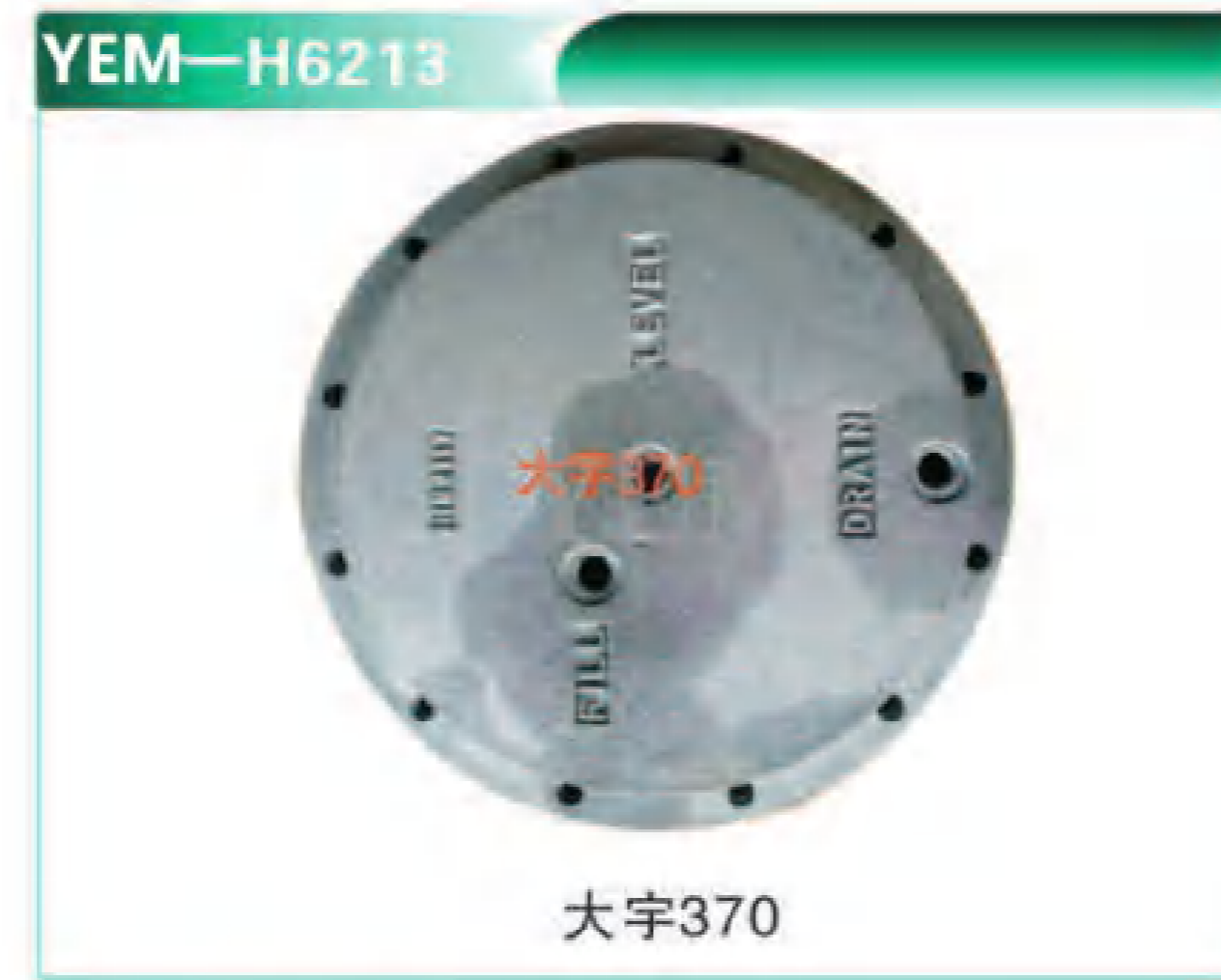
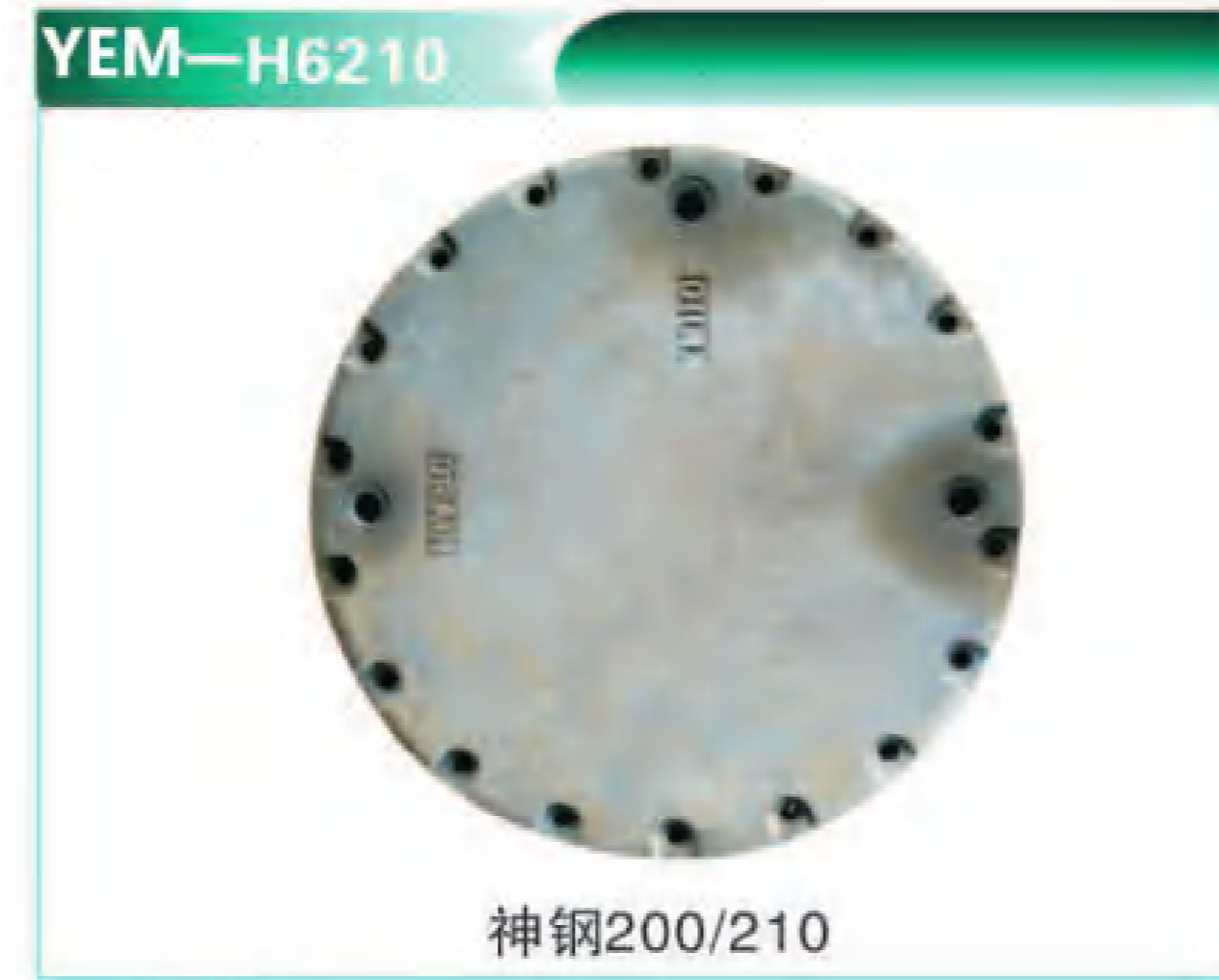
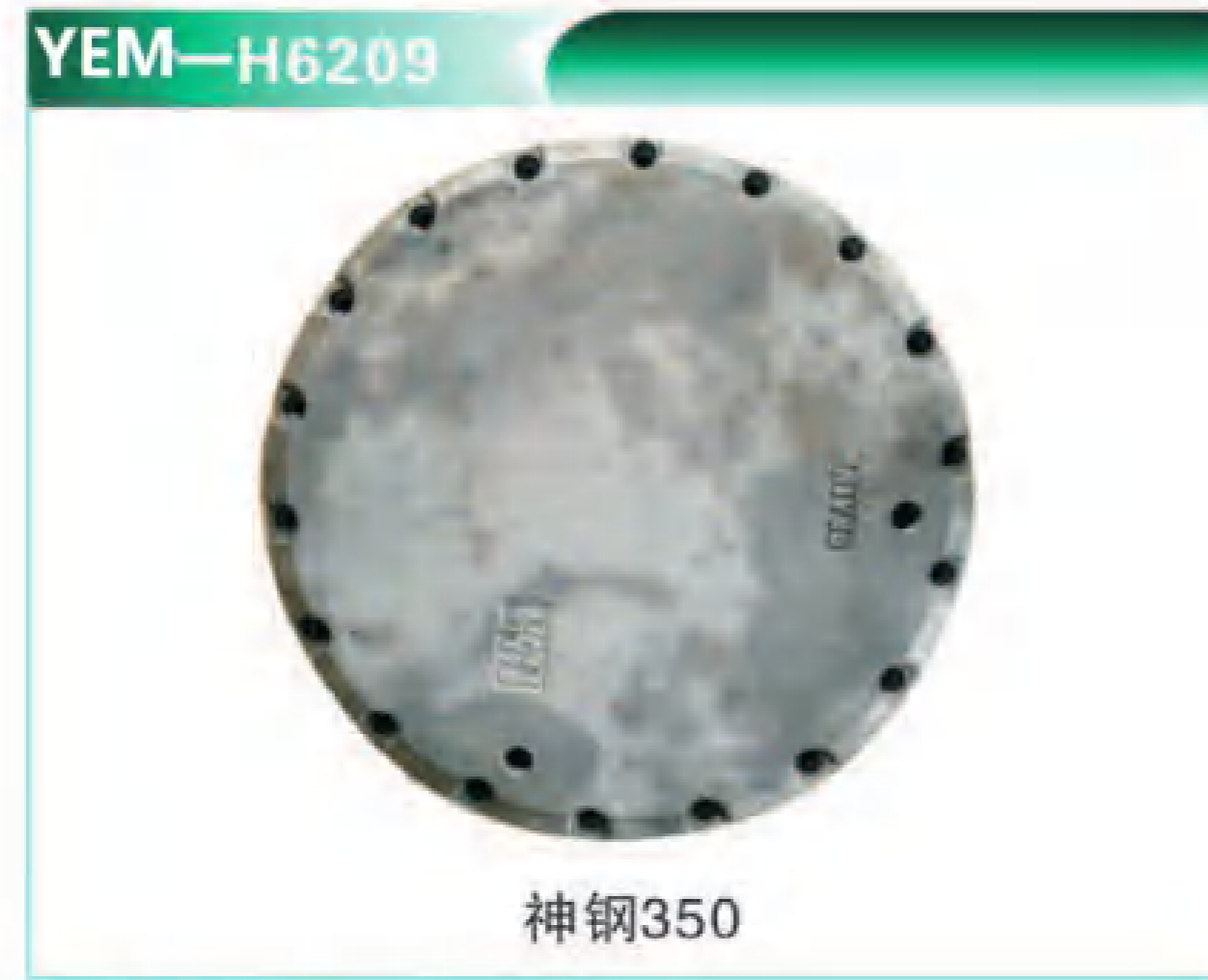
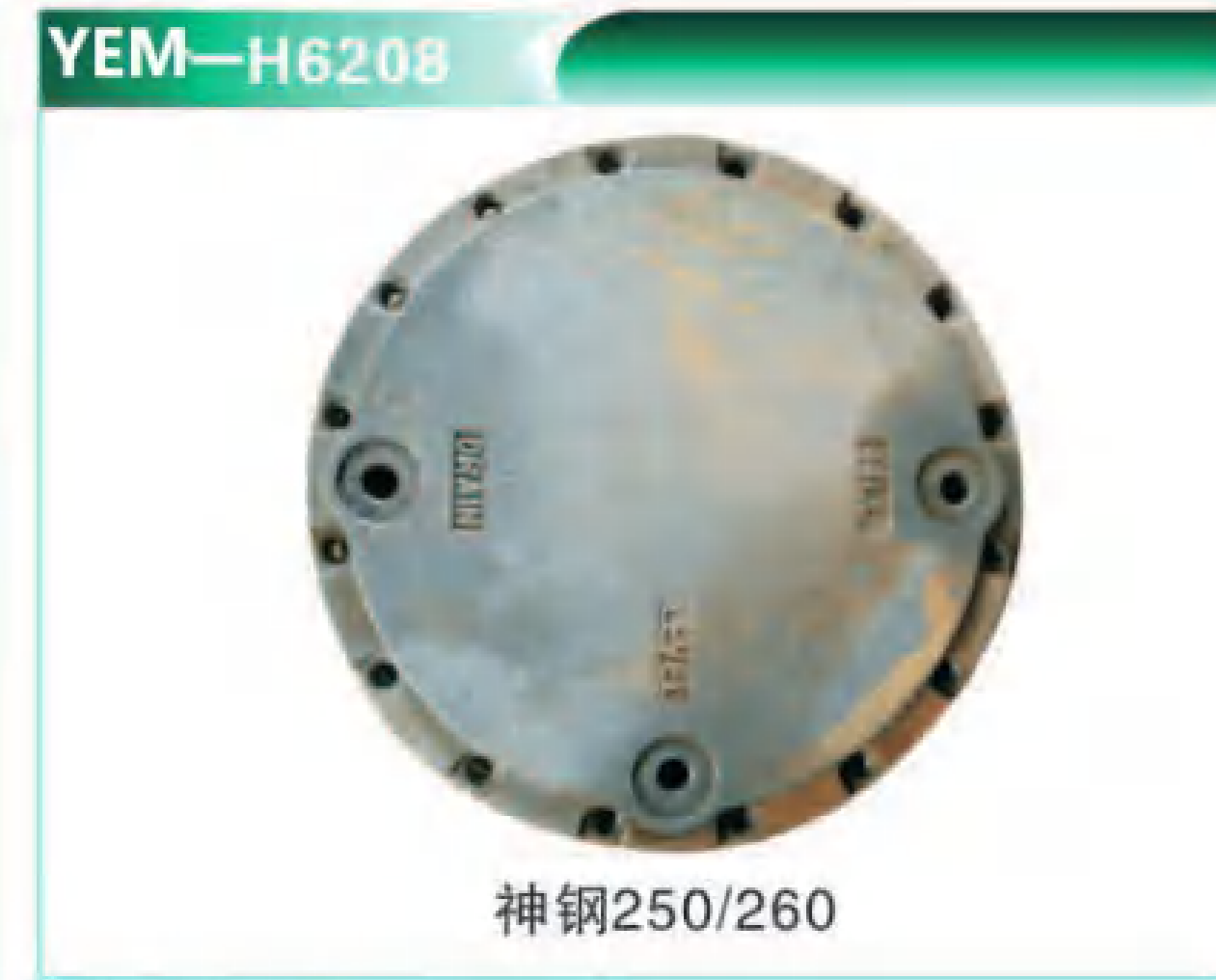

YEM-H6233



沃尔沃/VOLVO EC130

YEM-H6234



沃尔沃/VOLVO EC210/240/290新款

YEM-H6235



沃尔沃/VOLVO EC210B老款

YEM-H6236



沃尔沃/VOLVO EC240B老款

YEM-H6237



沃尔沃/VOLVO EC290B老款

YEM-H6238



沃尔沃/VOLVO EC460新款

YEM-H6239



沃尔沃/VOLVO EC460老款

YEM-H6240



卡特/CARTER CAT320/320B

YEM-H6241



卡特/CARTER CAT320C

YEM-H6242



卡特/CARTER CAT330C

YEM-H6243



加藤/KATO HD1430

YEM-H6244



中联/ZOOMLION ZE205E
柳工/LIUGONG LG920/922
三一/SANY SY200/210/205/215

YEM-H6245



三一/SANY SY310/330/360

YEM-H6246



三一/SANY 柳工/LIUGONG
徐工/XCMG 中联/ZOOMLION
山河/SUNWARD DOMESTIC 13T

YEM-H6247



中联/ZOOMLION 厦工/SAHM
三一/SANY 柳工/LIUGONG 徐工/XCMG
山河/SUNWARD DOMESTIC 20T/30T

YEM-H6248



神钢/KOBELCO SK135SR-2

YEM-H6249



神钢/KOBELCO SK135-8

YEM-H6250



神钢/KOBELCO SK200-6/6E/200-8

YEM-H6251



神钢/KOBELCO SK230-6

YEM-H6252



神钢/KOBELCO SK330-6E/320-6/350-8

YEM-H6253



日立/HITACHI ZX200/230

YEM-H6254



日立/HITACHI EX200-5/220-5

YEM-H6255



日立/HITACHI ZX330-1/-3

YEM-H6256



日立/HITACHI ZX870-3

YEM-H6257



住友/SUMITOMO SH240-3
凯斯/CASE CX240

YEM-H6258



住友/SUMITOMO SH240-5

YEM-H6259



住友/SUMITOMO SH350-5

回转牙箱 ROTARY TOOTH BOX

回转牙箱 ROTARY TOOTH BOX

YEM-H6260



DH55回转

YEM-H6261



DH80回转

YEM-H6262



DH150-7回转

YEM-H6272



E318回转

YEM-H6273



E320C回转

YEM-H6274



EC210回转

YEM-H6263



DH220-5回转

YEM-H6264



DH225-7回转

YEM-H6265



DH258回转

YEM-H6275



EC360回转

YEM-H6276



EX200-5回转

YEM-H6277



HD820回转

YEM-H6266



DH300-7回转

YEM-H6267



DH370回转

YEM-H6268



DH500回转

YEM-H6278



JCM913回转

YEM-H6279



JMF29回转

YEM-H6280



LG200(180)

YEM-H6269



DX60回转

YEM-H6270



E307-E回转

YEM-H6271



E307回转

YEM-H6281



LG200(190)

YEM-H6282



LG225(180)

YEM-H6283



LG225(190)

YEM-H6284



LG240回转

回转牙箱 ROTARY TOOTH BOX

<p>YEM-H6285</p>  <p>LG908回转</p>	<p>YEM-H6286</p>  <p>PC56回转</p>	<p>YEM-H6287</p>  <p>PC60-7回转</p>	<p>YEM-H6288</p>  <p>PC120-6回转</p>
<p>YEM-H6289</p>  <p>PC200-6回转</p>	<p>YEM-H6290</p>  <p>PC200-7 (矮) 回转</p>	<p>YEM-H6291</p>  <p>PC200-7 (高) 回转</p>	<p>YEM-H6292</p>  <p>PC200-8回转</p>
<p>YEM-H6293</p>  <p>PC220-7回转</p>	<p>YEM-H6294</p>  <p>R55回转</p>	<p>YEM-H6295</p>  <p>R80-7回转</p>	<p>YEM-H6296</p>  <p>R130回转</p>
<p>YEM-H6297</p>  <p>R210回转</p>	<p>YEM-H6298</p>  <p>R305-7回转</p>	<p>YEM-H6299</p>  <p>SH120回转</p>	<p>YEM-H6300</p>  <p>SH200回转</p>

回转牙箱 ROTARY TOOTH BOX

<p>YEM-H6301</p>  <p>SH280回转</p>	<p>YEM-H6302</p>  <p>SK60-5回转</p>	<p>YEM-H6303</p>  <p>SK75-8回转</p>	<p>YEM-H6304</p>  <p>SK135回转</p>
<p>YEM-H6305</p>  <p>SK140-8回转</p>	<p>YEM-H6306</p>  <p>SK200-6回转</p>	<p>YEM-H6307</p>  <p>SK200-8回转</p>	<p>YEM-H6308</p>  <p>SK250-8回转</p>
<p>YEM-H6309</p>  <p>SY75回转</p>	<p>YEM-H6310</p>  <p>SY135回转</p>	<p>YEM-H6311</p>  <p>YC60回转</p>	<p>YEM-H6312</p>  <p>YC85回转</p>
<p>YEM-H6313</p>  <p>ZAX60回转</p>	<p>YEM-H6314</p>  <p>ZAX70回转</p>	<p>YEM-H6315</p>  <p>山河50回转</p>	<p>YEM-H6316</p>  <p>山河70回转</p>

牙箱总成 TOOTH BOX ASSY

回转牙箱外壳 ROTATING TOOTH BOX HOUSING

机型 MODELS	机型 MODELS	机型 MODELS	机型 MODELS	机型 MODELS
PC30-7行走	E85旋转	EX60-5旋转	SK200-8行走	R305-7行走
PC40-7行走	E120B行走	ZX60旋转	SK200-8旋转	R305-7旋转
PC40行走	E311行走	ZX70行走	SK230-6行走	R335-7旋转
PC50行走	E312行走	ZX70旋转	SK250-8旋转	EC55旋转
PC56-7行走	E312B行走	EX120-1行走	SK250-8行走	EC210行走
PC56-7旋转	E312C行走	EX120-2旋转	SK350-8行走	EC210旋转
PC60-5行走	E312V2行走	EX120-5行走	SK350-8旋转	EC240行走
PC60-6行走	E315行走	EX120-3行走	DH55行走	EC240B行走
PC60-7行走	E200B行走	EX120-2行走	DH55旋转	EC240旋转
PC60-7旋转	E200B旋转	EX120-5旋转	DH60-7行走	EC240B旋转
PC75UU行走	E320旋转	ZX120行走	DH60-7旋转	EC290行走
PC78行走	E320V2旋转	ZX120旋转	DH80行走	EC290旋转
PC78-6旋转	E320行走	EX200-1行走	DH80旋转	EC290B旋转
PC120-3行走	E320B行走	EX200-1旋转	DH150-7旋转	EC360行走
PC120-5行走	E320C行走	EX200-2行走	DH220-2旋转	EC360旋转
PC120-5旋转	E320C旋转	EX200-2旋转	DH220-3旋转	EC460旋转
PC120-6行走	E324D行走	EX200-5行走	DH220-5行走	龙工85旋转
PC120-6旋转	E325C行走	EX200-5旋转	DH220-5旋转	龙工200旋转
PC120-6(山)旋转	E329D行走	ZX200行走	DH225-7行走	柳工200旋转
PC160-7旋转	E330D行走	ZX200-3行走	DH225-7旋转	柳工240旋转
PC200-6(6D95)行走	SH60-6行走	ZX200旋转	DH225-9行走	厦工825旋转
PC200-6(6D102)行走	SH60旋转	EX220-5行走	DH258行走	徐工150D旋转
PC200-6(山)行走	SH75行走	ZX230行走	DH258旋转	徐工210旋转
PC200-6(山)旋转	SH120A1行走	ZX240-3行走	DH300-5行走	徐工370旋转
PC200-7行走	SH120A1旋转	EX300-1行走	DH300-5旋转	YC35行走
PC200-7旋转	SH120A2旋转	EX300-3行走	DH300-7行走	YC35旋转
PC200-8旋转	S265旋转	EX300-5行走	DH300-7旋转	YC35-6行走
PC200-8行走	FJ260旋转	ZX330-1行走	DH370-7行走	YC45-6旋转
PC220-7行走	SH200旋转	ZX330-3行走	DH370-7旋转	YC55旋转
PC220-7旋转	SH200A3行走	EX400-1旋转	DX350旋转	YC60-8行走
PC300-6行走	SH265-2行走	EX400-3行走	DH420-7行走	YC85-6旋转
PC300-6旋转	S280旋转	ZX450-3行走	R55-7旋转	YC230-8旋转
PC300-7行走	HD250行走	SK60-6行走	R60-7行走	山河70旋转
PC300-7旋转	HD307旋转	SK60-5旋转	R60-7旋转	山河80旋转
PC400-6行走	HD400GL旋转	SK75-8旋转	R80行走	SY75行走
PC400-7行走	HD550行走	SK135旋转	R80-7旋转	SY75旋转
PC400-7旋转	HD700-5旋转	SK130-8旋转	R130-5行走	SY200旋转
E305.5行走	HD700-7行走	SK200-1旋转	R130旋转	竹内160旋转
E306行走	HD800-7行走	SK200-3旋转	R150-9行走	IHI120旋转
E305.5旋转	HD820旋转	SK200-1行走	R150-9旋转	JY200旋转
E307行走	HD1250-7行走	SK200-5行走	R210-3旋转	JY210旋转
E70B行走	HD1430行走	SK200-5旋转	R225-7行走	JCB220旋转
E70B旋转	HD1430旋转	SK200-6旋转	R225-7旋转	福田65行走
E70B-7旋转	EX55行走	SK200-6E行走	R225-9行走	中联85行走
E80旋转	EX60-5行走	SK200-6行走	R300-5行走	



E320B旋转泵壳



E320C旋转泵壳4



E320旋转泵壳9



EX200-5旋转泵壳8副本



EX220-5旋转泵壳6



EX300-3旋转泵壳



EX300-5旋转泵壳



HD400-7旋转泵壳



PC60-7旋转泵壳



PC120-6(山)旋转泵壳



PC120-6旋转泵壳



PC200-6(山)旋转泵壳



PC200-7旋转泵壳



PC200-8旋转泵壳



PC300-7旋转泵壳

回转牙箱外壳 ROTATING TOOTH BOX HOUSING

行走齿圈 WALKING RING
回转齿圈 ROTARY GEAR COMPONENTS

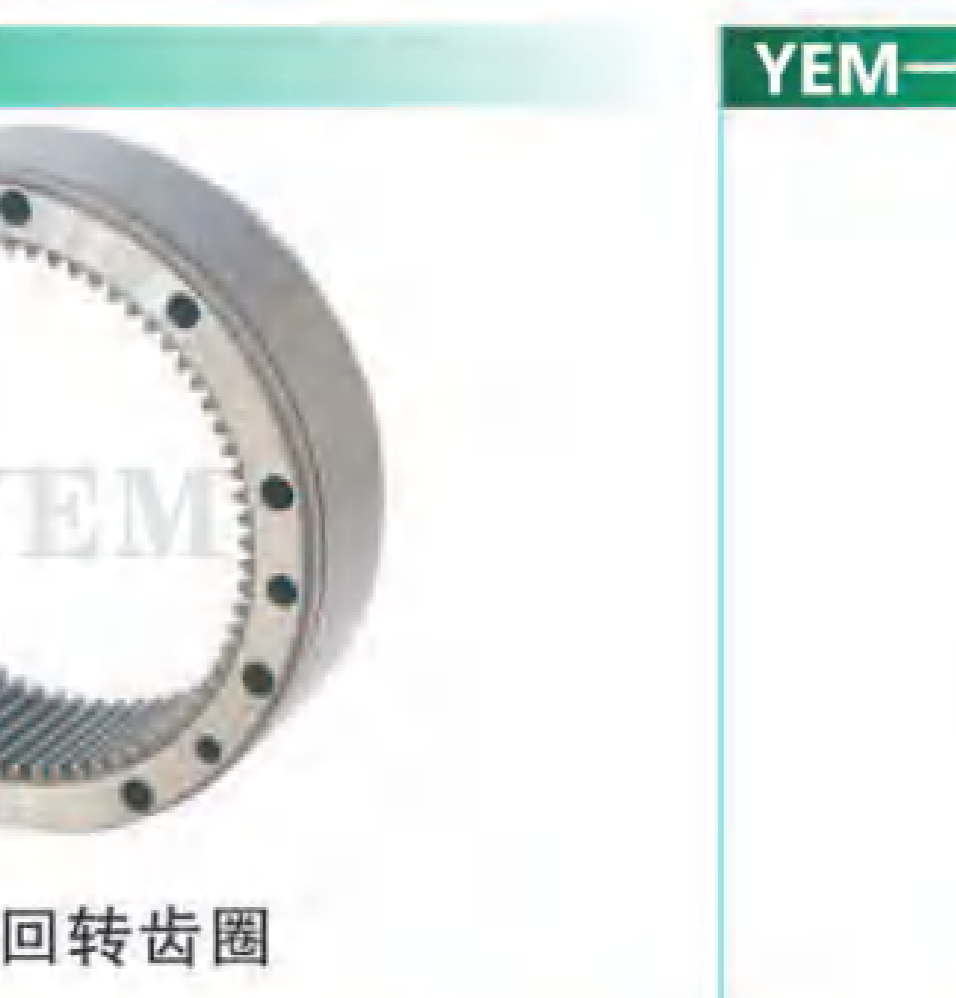

行走一二级总成
WALKING ONE OR TWO LEVEL ASSEMBLY

回转二级总成
ROTARY TWO STAGE ASSEMBLY









<p>YEM-H6365</p>  <p>DH225-9行走一二级总成</p>	<p>YEM-H6366</p>  <p>DH300-7行走一二三级总成</p>	<p>YEM-H6367</p>  <p>ZAX230行走一二三级总成</p>	<p>YEM-H6368</p>  <p>ZAX330-3行走一二三级总成</p>
<p>YEM-H6369</p>  <p>DH370行走一二级总成</p>	<p>YEM-H6370</p>  <p>E320C行走一二级总成</p>	<p>YEM-H6371</p>  <p>EC210行走一二级总成</p>	<p>YEM-H6372</p>  <p>EC290行走一二级总成</p>
<p>YEM-H6373</p>  <p>EX200-5行走一二三级总成</p>	<p>YEM-H6374</p>  <p>PC200-7行走一二级总成</p>	<p>YEM-H6375</p>  <p>PC360-7行走一二级总成</p>	<p>YEM-H6376</p>  <p>R305-7行走一二三级总成</p>
<p>YEM-H6377</p>  <p>SH200A3行走一二级总成</p>	<p>YEM-H6378</p>  <p>SH280行走一二三级总成</p>	<p>YEM-H6379</p>  <p>SK200-8行走一二级总成</p>	<p>YEM-H6380</p>  <p>SK350-8行走一二级总成</p>
<p>YEM-H6381</p>  <p>19X28双联齿总成</p>	<p>YEM-H6382</p>  <p>20X28双联齿总成</p>	<p>YEM-H6383</p>  <p>订做产品</p>	

<p>YEM-H6384</p>  <p>DH55回二总成</p>	<p>YEM-H6385</p>  <p>DH225-7回二总成</p>	<p>YEM-H6386</p>  <p>E318回二总成</p>	<p>YEM-H6387</p>  <p>E320C回二总成</p>
<p>YEM-H6388</p>  <p>EC210回二总成</p>	<p>YEM-H6389</p>  <p>EC360回二总成</p>	<p>YEM-H6390</p>  <p>EX200-5回二总成</p>	<p>YEM-H6391</p>  <p>LG200回二总成</p>
<p>YEM-H6392</p>  <p>LG225回二总成</p>	<p>YEM-H6393</p>  <p>PC120-6回二总成</p>	<p>YEM-H6394</p>  <p>PC200-6回二总成</p>	<p>YEM-H6395</p>  <p>PC200-7回二总成</p>
<p>YEM-H6396</p>  <p>PC240-8回二总成</p>	<p>YEM-H6397</p>  <p>R210回二总成</p>	<p>YEM-H6398</p>  <p>SH200回二总成</p>	
<p>YEM-H6399</p>  <p>SK200-6回二总成</p>	<p>YEM-H6400</p>  <p>SK200-8回二总成</p>	<p>YEM-H6401</p>  <p>SY135回二总成</p>	

回转一级总成 ROTARY PRIMARY ASSEMBLY
回转立轴 ROTARY SHAFT COMPONENTS

分配器总成 DISTRIBUTOR ASSEMBLY

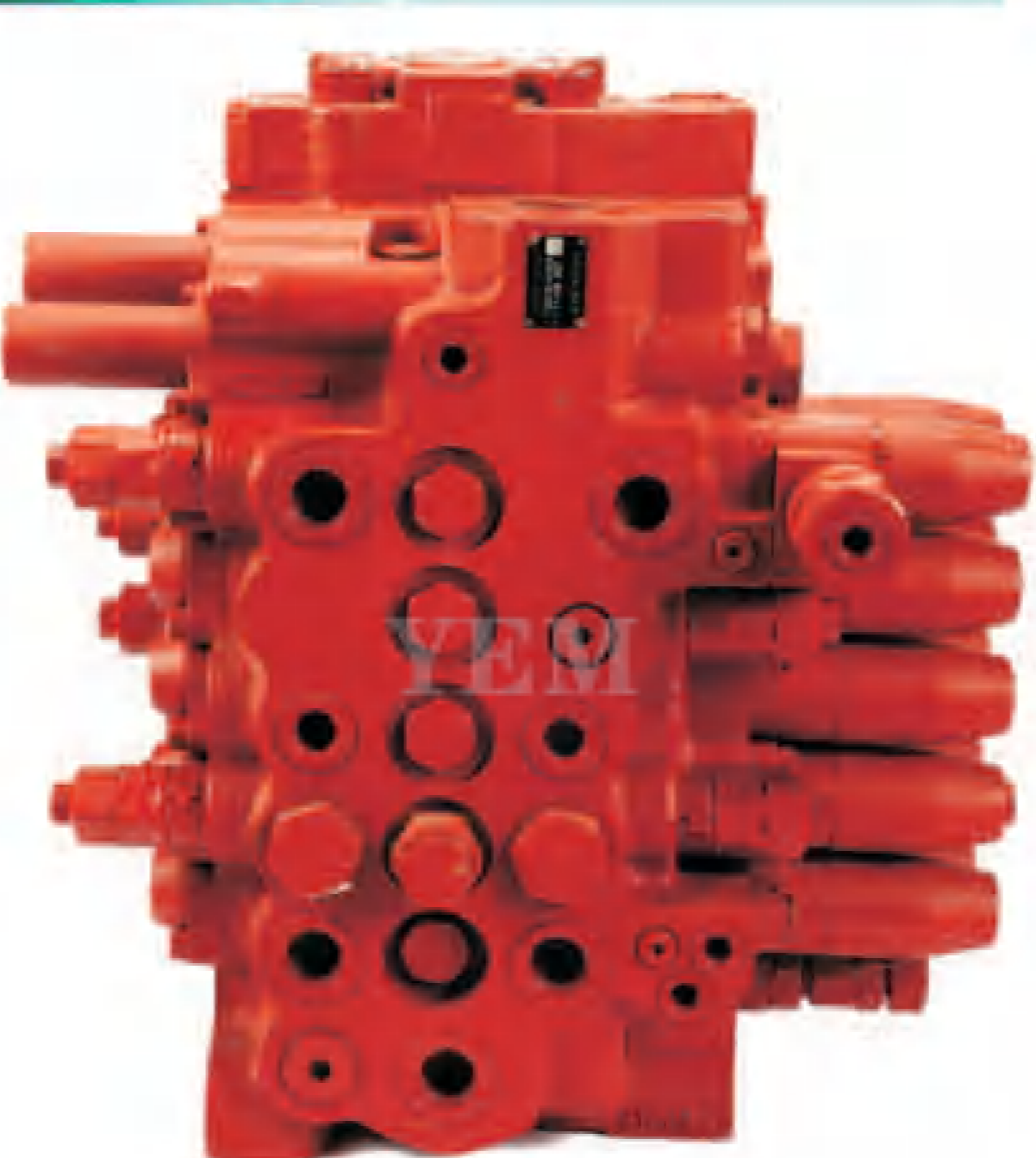
<p>YEM-H6402</p>  <p>DH220-5回一总成</p>	<p>YEM-H6403</p>  <p>DH300-7回一总成</p>	<p>YEM-H6404</p>  <p>E200B回一总成</p>	<p>YEM-H6405</p>  <p>EC210回一总成</p>	
<p>YEM-H6406</p>  <p>LG225回一总成</p>	<p>YEM-H6407</p>  <p>PC200-8回一总成</p>	<p>YEM-H6408</p>  <p>SK250-8回一总成</p>	<p>YEM-H6409</p>  <p>YC60-8回一总成</p>	<p>YEM-H6410</p>  <p>山河50回一总成</p>
<p>YEM-H6411</p>  <p>DH370回转立轴</p>	<p>YEM-H6412</p>  <p>EC210回转立轴</p>	<p>YEM-H6413</p>  <p>LG240回转立轴</p>	<p>YEM-H6414</p>  <p>PC200-7回转立轴</p>	
<p>YEM-H6415</p>  <p>R80-7</p>	<p>YEM-H6416</p>  <p>SH200</p>	<p>YEM-H6417</p>  <p>SK200-8回转立轴</p>	<p>YEM-H6418</p>  <p>SK250-8</p>	<p>YEM-H6419</p>  <p>ZAX70回转立轴</p>

<p>YEM-H6420</p>  <p>日本川崎KMX32N-B45008D</p>	<p>YEM-H6421</p>  <p>日本川崎KMX15RA-B45013</p>	<p>YEM-H6422</p>  <p>力士力-M9</p>
<p>YEM-H6423</p>  <p>(先进QF28-5-53</p>	<p>YEM-H6424</p>  <p>(日本川崎KMX15RA-B45012B</p>	<p>YEM-H6425</p>  <p>赫斯科 (HUSCO-H11</p>
<p>YEM-H6426</p>  <p>(KYB-C0170-41015</p>	<p>YEM-H6427</p>  <p>第一油压-8MCMV-16N</p>	<p>YEM-H6428</p>  <p>(KYB-C0170-33170</p>

分配器总成 DISTRIBUTOR ASSEMBLY

分配器总成 DISTRIBUTOR ASSEMBLY

YEM-H6429



KMX15RA

YEM-H6430



东芝 UX22

YEM-H6431



东芝 UX32

YEM-H6438



东芝 IB18

YEM-H6439



KYB-C0070-36942

YEM-H6440



纳博主控阀218691-01

YEM-H6432



派克 AV280

YEM-H6433



先进 AV280

YEM-H6434



意大利主控阀

YEM-H6441



派克 6T 阀

YEM-H6442



韩国油研阀

YEM-H6443



力士乐 SX12 8片 阀

YEM-H6435

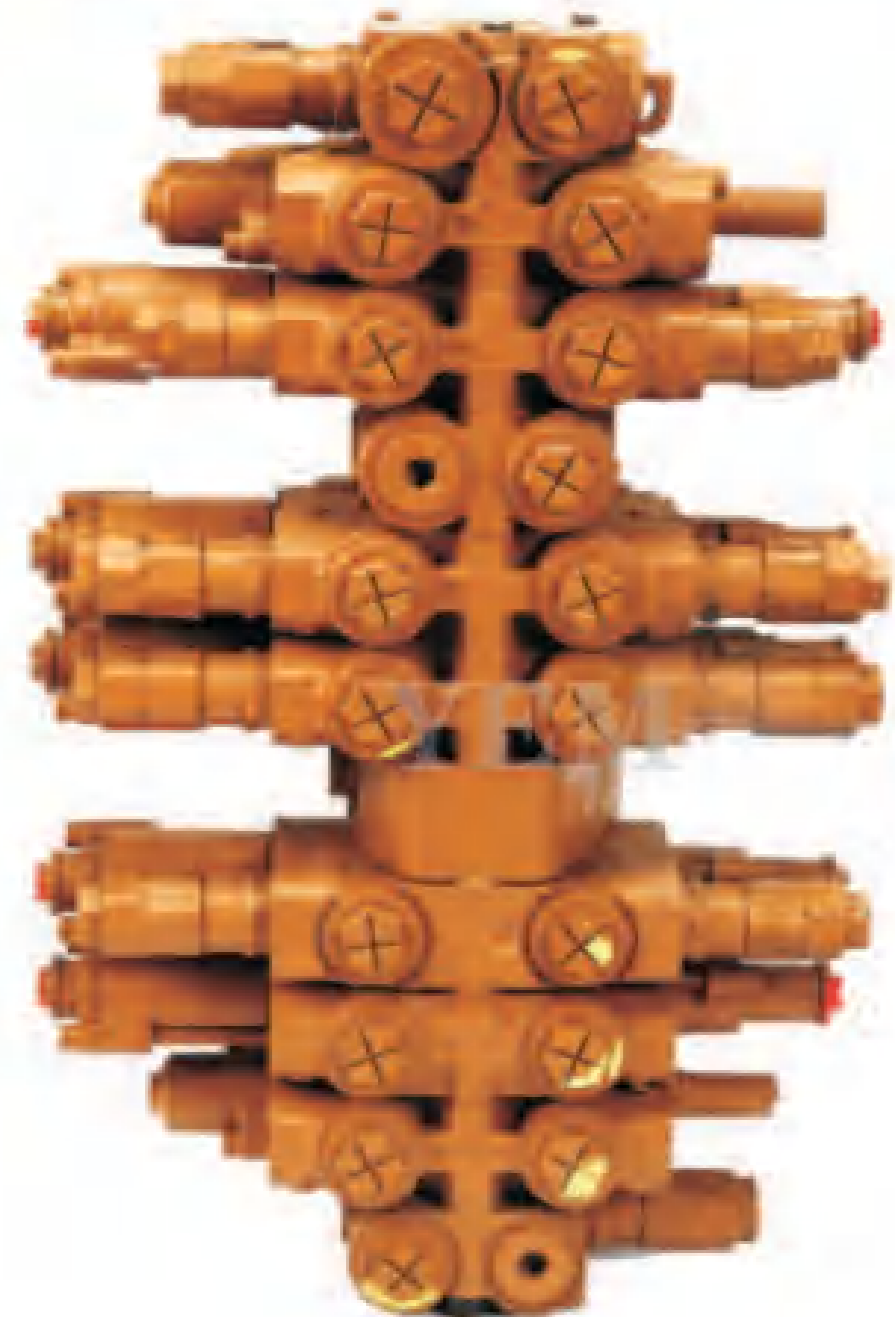

玉柴 3555 阀

YEM-H6436



东芝 UX28

YEM-H6437



KYB-C0170-31104

YEM-H6444



现代-31Q9-17110
KMX15NB/B45042
12720743

YEM-H6445



现代-31Q7-10111
KMX15NB/B45011D
15214466

YEM-H6446



力士乐 9片 阀

分配阀盖 DISTRIBUTING VALVE COVER

分配阀盖 DISTRIBUTING VALVE COVER

YEM-H6447  KMX151A	YEM-H6448  KMX151行走	YEM-H6449  E200B	YEM-H6450  E200B
YEM-H6451  VOLVO480	YEM-H6452  CAT312大	YEM-H6453  CAT312小	YEM-H6454  KMX32
YEM-H6455  KMX15高	YEM-H6456  KMX13	YEM-H6457  KYB	YEM-H6458  KMX15矮
YEM-H6459  KMX15RB	YEM-H6460  KMX15	YEM-H6461  PC200-5	YEM-H6462  CAT308
YEM-H6463  力士乐	YEM-H6464  HD820	YEM-H6465  ZAX200	YEM-H6466  YC85
YEM-H6467  DH55	YEM-H6468  AV280高	YEM-H6469  AV280矮	YEM-H6470  Ec210

YEM-H6471  CAT200B	YEM-H6472  E301	YEM-H6473  CAT320矮	YEM-H6474  CAT308
YEM-H6475  CAT312小	YEM-H6476  E301	YEM-H6477  CAT320C	YEM-H6478  CAT320C/D
YEM-H6479  CAT307V2	YEM-H6480  CAT320双肩	YEM-H6481  CAT349	YEM-H6482  PC双联
YEM-H6483  PC双联	YEM-H6484  PC双联	YEM-H6485  PC单联	YEM-H6486  PC60-6
YEM-H6487  PC130-7	YEM-H6488  PC200-7	YEM-H6489  PC50/60	YEM-H6490  PC200-5
YEM-H6491  ZAX70矮	YEM-H6492  ZAX70高	YEM-H6493  EX70高	YEM-H6494  EX70矮

分配阀盖 DISTRIBUTING VALVE COVER

分油忠 (回转接头) 总成
OIL DISTRIBUTOR (ROTARY JOINT) ASSY

<p>YEM-H6495</p>  <p>ZAX200直喷五联</p>	<p>YEM-H6496</p>  <p>ZAX200电喷四联</p>	<p>YEM-H6497</p>  <p>ZAX200电喷五联</p>	<p>YEM-H6498</p>  <p>ZAX200直喷四联</p>	
<p>YEM-H6499</p>  <p>ZAX200</p>	<p>YEM-H6500</p>  <p>EC210B</p>	<p>YEM-H6501</p>  <p>EC210B 铝</p>	<p>YEM-H6502</p>  <p>斗山55/60</p>	
<p>YEM-H6503</p>  <p>小 大 SK200-8</p>	<p>YEM-H6504</p>  <p>HD450</p>	<p>YEM-H6505</p>  <p>SH240A5 矮</p>	<p>YEM-H6506</p>  <p>CS/SH210/240高</p>	<p>YEM-H6507</p>  <p>SH200A5 高</p>
<p>YEM-H6508</p>  <p>CS/SH210/240矮</p>	<p>YEM-H6509</p>  <p>不二越</p>	<p>YEM-H6510</p>  <p>YC85 IB18分配器</p>	<p>YEM-H6511</p>  <p>派克3.5吨</p>	<p>YEM-H6512</p>  <p>力士乐</p>
<p>YEM-H6513</p>  <p>力士乐 8吨</p>	<p>YEM-H6514</p>  <p>力士乐 6吨</p>	<p>YEM-H6515</p>  <p>KMX15 高</p>	<p>YEM-H6516</p>  <p>KMX32N</p>	<p>YEM-H6517</p>  <p>KMX32N</p>
<p>YEM-H6518</p>  <p>KMX13</p>	<p>YEM-H6519</p>  <p>KYB</p>	<p>YEM-H6520</p>  <p>KMX15 双孔</p>	<p>YEM-H6521</p>  <p>KMX15</p>	<p>YEM-H6522</p>  <p>KYB20吨</p>

<p>YEM-H6523</p>  <p>分油中总成 ZAX70/120不带铲</p>	<p>YEM-H6524</p>  <p>分油中总成 ZAX200</p>	<p>YEM-H6525</p>  <p>分油中总成 ZAX240-3G</p>
<p>YEM-H6526</p>  <p>SK200-6分油中</p>	<p>YEM-H6527</p>  <p>分油中总成 SK200-8/250-8</p>	<p>YEM-H6528</p>  <p>分油中总成 PC120-5/6/7</p>
<p>YEM-H6529</p>  <p>分油中总成 PC200-7/8</p>	<p>YEM-H6530</p>  <p>三一55/65/75回转接头</p>	<p>YEM-H6531</p>  <p>三一195/205/215/235分油中</p>
<p>YEM-H6532</p>  <p>三一285/305/335/365分油中</p>	<p>YEM-H6533</p>  <p>柳工回转接头</p>	<p>YEM-H6534</p>  <p>厦工回转接头</p>

分油忠 (回转接头)总成
OIL DISTRIBUTOR (ROTARY JOINT) ASSY

液压风扇泵 HYDRAULIC FAN PUMP

YEM-H6535



分油中总成

YEM-H6536



分油中总成

YEM-H6537



分油中总成

YEM-H6547



330C风扇泵
283-5992

YEM-H6548



336D风扇泵
259-0815

YEM-H6549



345D风扇泵
295-9426

YEM-H6538



分油中总成

YEM-H6539



分油中总成

YEM-H6540



分油中总成

YEM-H6550



CAT
32180620

YEM-H6551



风扇泵E345C
247-8917

YEM-H6552



风扇泵E345B
259-0814

YEM-H6541



福田回转接头

YEM-H6542



中联回转接头

YEM-H6543



分油中总成

YEM-H6553



CAT
35024544/2017W15
187-9090 05

YEM-H6554



E325C

YEM-H6555



DX500

YEM-H6544



分油中总成

YEM-H6545



分油中总成

YEM-H6546



SK200/250-8分油中

YEM-H6556



HYUNDAI
31Q4-30202

YEM-H6557



HYUNDAI 31QP
31Q9-30213

YEM-H6558



31Q4-30202

YEM-H6559



330C风扇马达 191-5611

YEM-H6560



E325C 风扇马达 179-9778

YEM-H6561



330D风扇马达 234-4638

YEM-H6562



E345B 247-8978

YEM-H6575



980G风扇马达

YEM-H6576



74318DDA风扇马达

YEM-H6577



74318RAA风扇马达

YEM-H6578



74328风扇马达

YEM-H6563



E345D风扇马达 266-8034
E349D风扇马达 225-4613

YEM-H6564



E385风扇马达双向 274-8978

YEM-H6565



E345C 136-8869 带梭阀

YEM-H6566



CAT966风扇马达

YEM-H6579



VOLVO 14543168

YEM-H6580



VOLVO
14602247/14561971

YEM-H6581



VOLVO
14602252/14530502

YEM-H6582



VOLVO 14561970

YEM-H6567



JCB风扇马达

YEM-H6568



日立 024-94578

YEM-H6569



日立KYB风扇马达
B0440-50005

YEM-H6570



31QP-30130

YEM-H6583



VOLVO 14537295

YEM-H6584



VOLVO
R902415267
34753040

YEM-H6585



凯斯 PC

YEM-H6586



凯斯 PC

YEM-H6571



31NB-30020

YEM-H6572



A
MSF16风扇马达 VOV360
B
MSF23风扇马达 VOV700

YEM-H6573



VOLVO18风扇马达

YEM-H6574



825G风扇马达

YEM-H6587



日立/柳工906

YEM-H6588



日立

YEM-H6589



小松风扇泵

YEM-H6590



小松风扇泵

风扇离合器/风扇支架
FAN CLUTCH/FAN SUPPORT

风扇离合器/风扇支架
FAN CLUTCH/FAN SUPPORT

YEM-H6591



小松风扇泵

YEM-H6592



VOV480-380 取力器

YEM-H6593



VOV360-460 取力器

YEM-H6594



VOV驱动装置

YEM-H6595



ZAX450风扇支架

YEM-H6596



VOV360/460风扇支架

YEM-H6597



VOV380/480风扇支架

YEM-H6598

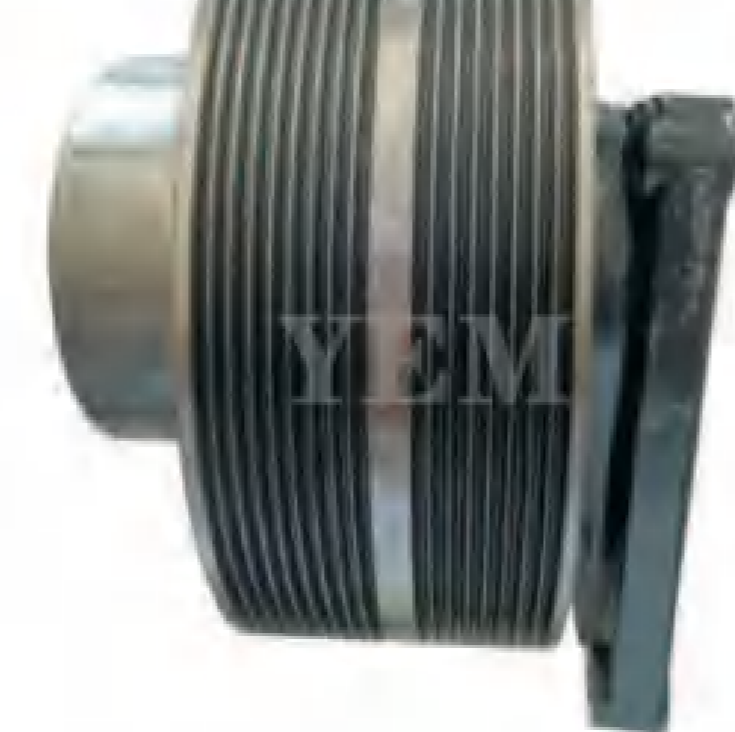

PC360-7风扇支架

YEM-H6599



现代风扇支架

YEM-H6600



卡特风扇支架

YEM-H6601



A
E320D风扇离合器
E320D
281-3588
FAN CLUTCH

B
E320D风扇离合器
E329D
281-3589
FAN CLUTCH

YEM-H6602

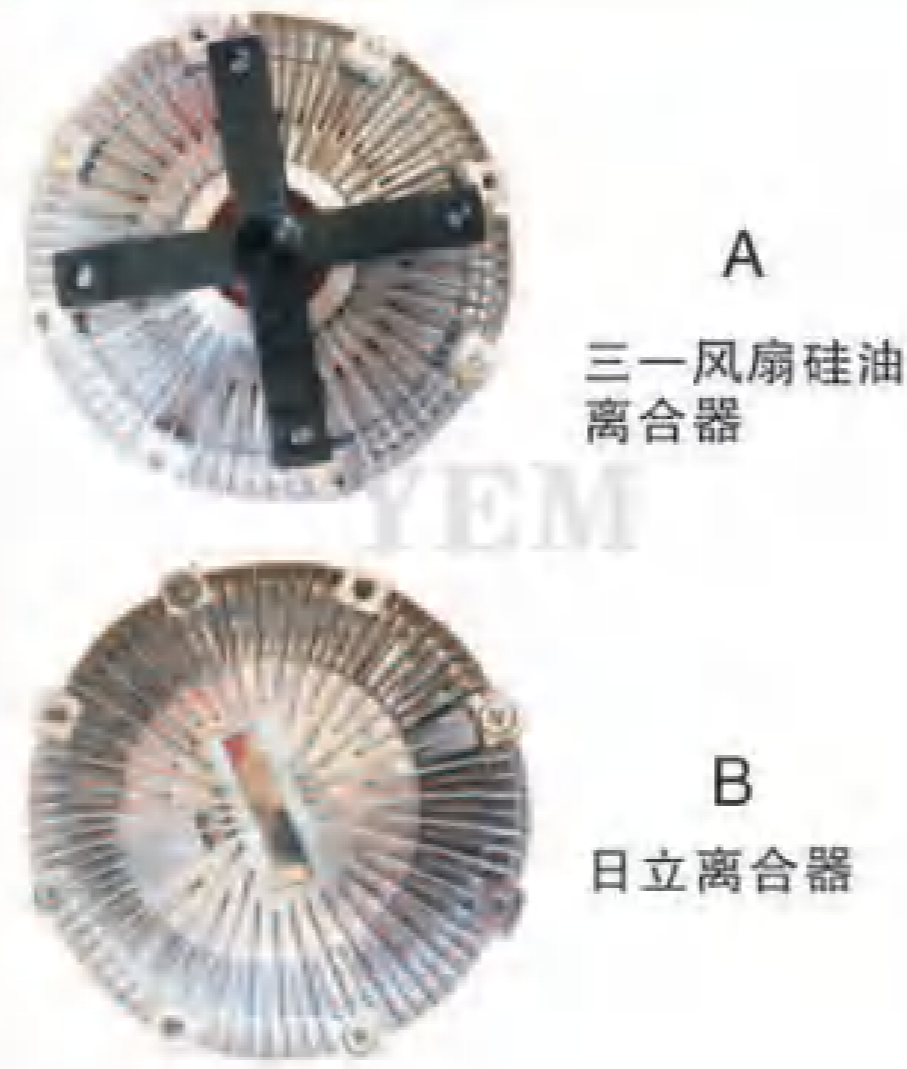

A
三一风扇硅油
离合器

B
日立离合器

YEM-H6603



现代60风扇离合器
R60-9
11Q6-00200
FAN CLUTCH

YEM-H6604



11Q6-00260

YEM-H6605



11Q6-01180

YEM-H6606



11Q6-00370

YEM-H6607



E349风扇离合器

YEM-H6608



五十铃风扇硅油离合器

YEM-H6609



281-3588
卡特320D 老款

YEM-H6610



324-0123
卡特320D 新款

YEM-H6611



281-3589
卡特325D 329D 老款

YEM-H6612



418-2229
卡特320D2 9叶720风叶

YEM-H6613



359-2658
卡特330D2 11叶810风叶

YEM-H6614



11Q6-00200
现代60-9 温控

YEM-H6615



11Q6-01180/190
现代225/275-9 4孔 康明斯

YEM-H6616



11Q6-00260
现代215-9/-9C 6孔 三菱动力

YEM-H6617



11Q6-00250
现代老款6孔 外径186

YEM-H6618



418-2232
卡特336D2 11叶风叶810

YEM-H6623



油源阀块总成

YEM-H6624



油源阀块总成

YEM-H6625



油源阀块总成

YEM-H6626



油源阀块总成

YEM-H6627



油源阀块总成

YEM-H6628



油源阀块总成

YEM-H6629



油源阀块总成

YEM-H6630



油源阀块总成

YEM-H6631



油源阀块总成

YEM-H6632



油源阀块总成

YEM-H6633



油源阀块总成

YEM-H6634



油源阀块总成

YEM-H6635



油源阀块总成

YEM-H6636

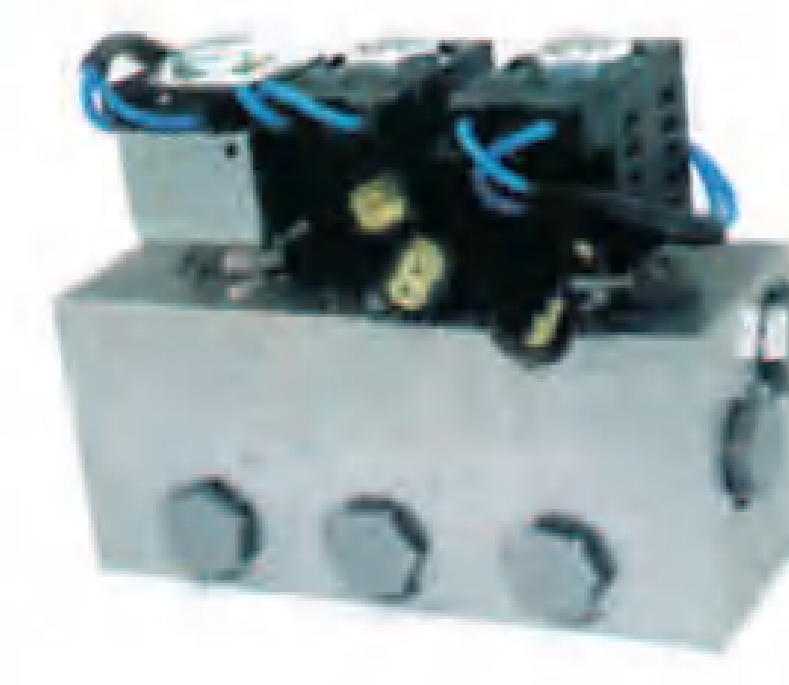

油源阀块总成

YEM-H6637



油源阀块总成

YEM-H6638



蓄能器(圆球)

YEM-H6639



K3V63DT
K3V153-80413
安装孔径
80mm
4孔13齿
2油管/3油管
适用机型
DH513
R130
SK100-3/5等

YEM-H6640



K3V63DT
K3V154-80413
安装孔径
80mm
4孔13齿
3油管/4油管
适用机型
SK200-5等

YEM-H6641



K3V63BDT
SH200A3
K3V153-78213
安装孔径
78mm
2孔13齿
2油管/3油管
适用机型
SH200A3等

YEM-H6642



K3V112DT
K3V153-90413
安装孔径
90mm
4孔13齿
2油管/3油管
适用机型
HD820
HD1023
DH200-5等

YEM-H6643



K3V112DT
K3V154-90413
安装孔径
90mm
4孔13齿
3油管/4油管
适用机型
SK200-6
SK230-6
R200等

YEM-H6644



KP1009CLFSS
安装孔径
51mm
2孔12齿
2油管
适用机型
SK200
SH120
SK120-3/5等

YEM-H6645



4181700
9217993
安装孔径
83mm
11齿
2孔
两开口
适用机型
EX200-1
EX330-5
Zx330等

YEM-H6646



4255303
9218004
安装孔径
67mm
10齿
2孔
适用机型
EX100-2
EX120-2
EX200-2等

YEM-H6647



4276918
9218005
安装孔径
83mm
10齿
两开口
适用机型
EX100-3
EX200-3
ZX270等

YEM-H6648



UH083
4035495

YEM-H6649



14X-49-11600
安装孔径
72mm
13齿
适用机型
D65E-12
D65PX-12
D85E-SS-2等

YEM-H6650



KP1009CHFSS
安装孔径
51mm
2开口
2油管
适用机型
E200B
E180
E240B等

YEM-H6651



41-1023
安装孔径
51mm
2开口
2油管
适用机型
E312B
E312L
E320等

YEM-H6652



126-2016
安装孔径
82mm
2开口
2油管
适用机型
E320B
E320C
E320CU等

YEM-H6653



07432-72203
安装孔径
72mm
13齿
适用机型:
D65A-6
D65S-8
D65P-8等

YEM-H6654



07432-71203
安装孔径
72mm
13齿
适用机型
D65A-6
D85E-18
D80A-18等

YEM-H6655



95518-03001

YEM-H6656



EX30-2
EX35-2

YEM-H6663



斗山370

YEM-H6664



E330C

YEM-H6665



A8VO200

YEM-H6657



EX30-1
EX35-1

YEM-H6658



ZAX70

YEM-H6659



ZX55

YEM-H6669



PC300-6
OEM 704-24-26430

YEM-H6670



PC120-5

YEM-H6671



PC60-7

YEM-H6660



日立60

YEM-H6661



E307上法兰

YEM-H6662



CAT215
CAT229
CAT225B
CAT300B
A8V0107
(9T/10T)

YEM-H6672



A B
PC55/56/60 PC35/40/PVD-2B-36

YEM-H6673



PC30

YEM-H6674



PC45





YEM-H6723



PC30/40
HGP-2A-F12R

YEM-H6724



PC30/40矮

YEM-H6725



K35P36C

YEM-H6735



YEM-H6736



YEM-H6737



YEM-H6726



YEM-H6727



K5V200

YEM-H6728



YEM-H6738



YEM-H6739



YEM-H6740



YEM-H6729



YEM-H6730



YEM-H6731



YEM-H6741



YEM-H6742



YEM-H6743



YEM-H6732



YEM-H6733



YEM-H6734



YEM-H6744



YEM-H6745



YEM-H6746



YEM-H6771



YEM-H6772



YEM-H6773



YEM-H6783



YEM-H6784



YEM-H6785



CBQ100-1015

YEM-H6774



YEM-H6775



YEM-H6776



YEM-H6786



CBQ-2063-2063

YEM-H6787



1011-802D-802D-101

YEM-H6788



PC100-80

YEM-H6777



YEM-H6778



YEM-H6779



YEM-H6789



PC100-100

YEM-H6790



HP192003

YEM-H6791



100-80

YEM-H6780



Yc85

YEM-H6781



YEM-H6782



YEM-H6792



80-63-50

YEM-H6793



PARKE80-80-32

YEM-H6794



100工作泵

YEM-H6795



F63K13L

YEM-H6796



F50-18K13L

YEM-H6797



PARKER63-18

YEM-H6807



KP75B-1

YEM-H6808



KP55

YEM-H6809



YEM-H6798



PARKER63-35

YEM-H6799



PGP330

YEM-H6800



PC102自卸泵

YEM-H6810



YEM-H6811



YEM-H6812



YEM-H6801



PC101自卸泵

YEM-H6802



75A自卸泵

YEM-H6803



1405A自卸泵

YEM-H6813



YEM-H6814



YEM-H6815



YEM-H6804



KP1403A

YEM-H6805



KP1403A-1

YEM-H6806



KP75B

YEM-H6816



YEM-H6817



YEM-H6818







川崎系列 KAWASAKI SERIES 卡特叶片泵 CAT VANE PUMP

Indes	Parts No
1	YT28PL240011
2	KLD80Z 17PL220316A-9PL170702A
3	KLD80Z 13PL190313BK-13PL190711B
4	KLD90Z KFP5190-56KPR4-23ARG
5	KLD95Z 18PL240304BK-4.2PL170702C
6	KLD95Z-2 33PK240304BK-4.2PL170702C
7	KLD110Z 33PL24030BK-15PL190703B
8	KLD115Z 22PL220319A-10PL190703C
9	KLD115Z 22PL220319A-17PL220704A
10	B0319141071 PA1911Q3B26A
11	B0322150121 PA2215C5B20A
12	PAP191111Q32B2H2D2
13	PAP191111Q32B1
14	1161071100

Indes	Part No	Part No
1	3G2722	3G2834
2	3G2749	4T6869
3	1U2664	6E4258
4	3G2720	3G1267
5	3G2715	3G1266
6	3G7659	3G2835
7	4T3196	9T2200
8	3G7658	1U2667
9	1U2665	6E2396
10	3G2717	3G2837
11	1U3519	3G7651
12	3G2200	3G7665
13	3G7653	4T1893
14	9J7891	3G7664
15	1U3952	3G7666
16	3G2195	1U2669
17	3G7654	1U3953
18	3G7663	3G2236
19	1U2666	3G2238
20	3G2196	3G7661
21	3G2718	1U2670
22	3G7652	3G7656
23	1U2652	3G7660
24	3G2752	4T0416
25	3G7655	4T0422
26	3G7662	9T5336
27	4T0417	3G7657
28	4T2626	3G7667
29	1U2668	1U0532
30	3G2806	3G2234
31	3G2807	1U2671
32	9T5199	4W2448
33	1U1779	4W5479
34	6P7361	4N4873
35	3P6816 (14)	4N4864
36	3G4768	5H1719
37	1P4231	5M7864
38	2P9239	7S4629
39	3N2078	EU3507
40	3S4386	3P0380
41	3S2616	3P4002

JCB

JCB 3CX PARTS - HYDRAULIC PARKER PUMP
(PART NO- 20/925339, 332F/9030)

JCB 3CX SPARE PARTS - HYDRAULIC PARKER PUMP
(PART NO:- 20/925579, 332/F9029)

Pump main hydraulic 36/29 cc/rev
- JCB 3CX 4CX Backhoe
(Others Available)

CHARGING PUMP

Item No.	Part No.	Nos of Pump	Machine No.
1	385-10079282	Double pump 双联泵	540-1R
2	385-10234561	Double pump 双联泵	540-1R

装载机 LOADER

Item No.	Part No.	NOs of Pump	Machine No.
1	705-51-20390	Double pump双联泵	WA22-4R
2	705-11-21010	Single pump单泵	WA30-2
3	705-51-21000	Double pump双联泵	WA30-1
4	705-40-01000	Single pump单泵	WA40-2R
5	705-40-01010	Single pump单泵	WA30-3R
6	705-40-01320	Single pump单泵	WA30-52R
7	705-40-01470	Single pump单泵	WA50-3-C
8	705-40-01610	Single pump单泵	WA30-52R
9	705-41-01050	Single pump单泵	WA100
10	705-80-10000	Double pump双联泵	WA100
11	705-12-31010	Single pump单泵	WA100
12	704-31-24110	Single pump单泵	WA100-1
13	705-51-20790	Double pump双联泵	WA120L-3
14	705-11-33011	Single pump单泵	WA120-3-3T
15	705-11-34011	Single pump单泵	WA120-1 GD705A-4
16	705-11-34060	Single pump单泵	WA120-1 GD705A-5
17	705-73-30010	Single pump单泵	WA120-3-4
18	705-51-20180	Double pump双联泵	WA150-1C
19	705-56-34690	Triple pump三联泵	WA150-5R
20	705-73-29010	Single pump单泵	WA150-1C
21	705-51-20430	Double pump双联泵	WA180
22	705-51-20070	Double pump双联泵	WA180
23	705-51-20400	Double pump双联泵	WA200-1C PC80-1
24	705-51-20640	Double pump双联泵	WA200-1-A
25	705-52-20050	Double pump双联泵	WA200-1C PC80-1
26	705-51-20150	Double pump双联泵	WA200-1C PC80-1
27	705-56-26080	Quadruple pump四联泵	WA200-5
28	705-56-26081	Quadruple pump四联泵	WA200-5
29	705-56-26090	Quadruple pump四联泵	WA200-6
30	705-56-36040	Quadruple pump四联泵	WA250L1C
31	705-56-36080	Quadruple pump四联泵	WA250-6
32	705-56-36082	Quadruple pump四联泵	WA250-6
33	704-30-29110	Single pump单泵	WA250LOC
34	705-12-31240	Single pump单泵	WA250
35	705-51-20170	Double pump双联泵	WA250-0C
36	705-52-30150	Double pump双联泵	WA250-LC
37	705-51-10010	Double pump双联泵	WA260
38	705-41-05690	Single pump单泵	WA270-0R
39	705-11-34250	Single pump单泵	WA300/WA320

装载机 LOADER

Item No.	Part No.	NOs of Pump	Machine No.
40	705-12-32040	Single pump单泵	WA300/WA320
41	705-12-32010	Single pump单泵	WA300
42	705-51-22000	Double pump双联泵	WA300/WA320
43	705-51-20280	Double pump双联泵	WA300/WA350
44	705-51-20140	Double pump双联泵	WA300-1 WA320-1
45	705-55-24130	Triple pump三联泵	WA300L-1/WA320-3
46	705-55-24130	Triple pump三联泵	WA300L-1/WA320-3
47	705-51-32080	Double pump双联泵	WA320-1
48	705-52-32080	Double pump双联泵	WA320/WA350
49	705-55-34160	Quadruple pump四联泵	WA320-3C
50	705-32-43240	Single pump单泵	WA320
51	705-56-36050	Quadruple pump四联泵	WA320-6
52	704-30-32110	Single pump单泵	WA350-1
53	705-52-30190	Double pump双联泵	WA350-1M
54	705-55-33080	Triple pump三联泵	WA380-5WA400-5
55	198-49-34100	Double pump双联泵	WA375A-5R
56	705-11-36100	Single pump单泵	WA380
57	705-34-34340	Single pump单泵	WA380
58	705-56-34090	Quadruple pump四联泵	WA380-1
59	705-11-35010	Single pump单泵	WA380-1C
60	705-33-27540	Single pump单泵	WA380-3
61	705-33-28540	Single pump单泵	WA380-3
62	705-21-40020	Single pump单泵	WA380-3C
63	705-56-34180	Quadruple pump四联泵	WA380-1
64	705-55-34180	Quadruple pump四联泵	WA380-3C
65	705-55-34190	Quadruple pump四联泵	WA380-3
66	705-51-20440	Double pump双联泵	WA380-3C
67	705-52-30080	Double pump双联泵	WA380-1 WA350-0C
68	705-51-30600	Double pump双联泵	WA380-5
69	705-52-30220	Double pump双联泵	WA380-1/WA350-0C
70	705-52-20140	Double pump双联泵	WA380/WA400
71	705-52-20190	Double pump双联泵	WA380-5/WA400-5/WA470-1
72	705-52-20240	Double pump双联泵	WA380-5/WA400-5/WA470-1
73	704-30-34110	Single pump单泵	WA400-1
74	705-56-34040	Triple pump三联泵	WA400-1
75	705-56-34240	Triple pump三联泵	WA400-1
76	705-56-30560	Double pump双联泵	WA420-3CS
77	705-56-34100	Quadruple pump四联泵	WA420-1C
78	705-51-30710	Double pump双联泵	WA430-5C

装载机 LOADER

Item No.	Part No.	NOs of Pump	Machine No.
79	705-52-30390	Double pump双联泵	WA420-3D
80	705-52-30550	Double pump双联泵	WA420-3CS
81	705-52-30560	Double pump双联泵	WA420-3CS
82	705-11-35090	Single pump单泵	WA420-1H
83	705-55-33100	Triple pump三联泵	WA430-5-W
84	705-40-01020	Single pump单泵	WA430-6
85	705-22-36060	Single pump单泵	WA450-1-A
86	705-56-43020	Triple pump三联泵	WA450-3L
87	705-21-31020	Single pump单泵	WA450
88	705-24-28203	Single pump单泵	WA450
89	705-30-31203	Single pump单泵	WA450
90	705-51-20240	Double pump双联泵	WA450/WA470
91	705-51-20300	Double pump双联泵	WA450/WA470
92	705-51-20480	Double pump双联泵	WA450/WA470
93	705-51-30920	Double pump双联泵	WA450/WA470
94	705-36-29540	Single pump单泵	WA450-3/WA470-3
95	705-12-36010	Single pump单泵	WA450-1-A
96	705-12-37010	Single pump单泵	WA450-1-A
97	705-12-37040	Single pump单泵	WA450-2-A
98	705-14-41010	Single pump单泵	WA470-1
99	705-14-41040	Single pump单泵	WA470-1
100	705-36-30540	Single pump单泵	WA470
101	705-51-20090	Double pump双联泵	WA470-1
102	705-51-11020	Double pump双联泵	WA470-1
103	705-51-20290	Double pump双联泵	WA470-1
104	705-52-20100	Double pump双联泵	WA470-1
105	705-51-31140	Double pump双联泵	WA470-5S/N
106	705-51-30820	Double pump双联泵	WA470-6AS
107	705-52-30280	Double pump双联泵	WA470-3-X
108	705-41-07210	Double pump双联泵	WA470-5C
109	705-51-30580	Double pump双联泵	WA470-5L
110	705-52-40150	Double pump双联泵	WA470-3
111	705-52-40280	Double pump双联泵	WA470-3E
112	705-52-40130	Double pump双联泵	WA450-3A
113	705-51-31150	Double pump双联泵	WA480-5-W
114	705-51-30590	Double pump双联泵	WA480-5-W
115	705-55-43000	Triple pump三联泵	WA480-3-W
116	705-12-38011	Single pump单泵	WA500-3
117	705-22-40070	Single pump单泵	WA500-1-A

装载机 LOADER

Item No.	Part No.	NOs of Pump	Machine No.
118	704-30-36110	Single pump单泵	WA500-1-3
119	705-52-31130	Double pump双联泵	WA500-1
120	705-52-31230	Double pump双联泵	WA500-3C
121	705-22-44070	Single pump单泵	WA500-3/D155AX-5
122	705-38-39000	Single pump单泵	WA500
123	705-12-44010	Single pump单泵	WA500-3/D155AX-5
124	705-12-40040	Single pump单泵	WA500-3
125	705-22-40160	Single pump单泵	WA500
126	705-52-30260/31130	Double pump双联泵	WA500-1-A
127	705-52-30490	Double pump双联泵	WA500-3C
128	705-56-34130	Triple pump三联泵	WA500-1R
129	705-51-32040	Double pump双联泵	WA500/WA555
130	705-51-32060	Double pump双联泵	WA555
131	705-51-32000	Double pump双联泵	WA540B-1/WA120
132	705-52-31020	Double pump双联泵	WA600-3
133	705-52-31080	Double pump双联泵	WA600-3
134	705-52-31081	Double pump双联泵	WA600-3
135	704-30-42140	Single pump单泵	WA600-3C
136	705-55-43040	Triple pump三联泵	WA600-6S
137	705-56-44000	Triple pump三联泵	WA600-1-A
138	705-56-44001	Triple pump三联泵	WA600-1-A
139	705-56-44010	Triple pump三联泵	WA600-1-A
140	705-56-47000	Quadruple pump四联泵	WA600-3C
141	705-57-46000	Triple pump三联泵	WA600-1-A
142	705-58-46001	Triple pump三联泵	WA600-1-A
143	705-58-47000	Quadruple pump四联泵	WA600-1-A
144	705-53-31020	Double pump双联泵	WA600-3
145	705-53-42000	Double pump双联泵	WA600-3
146	705-53-42000	Double pump双联泵	WA600-3
147	705-53-42010	Double pump双联泵	WA600-3
148	705-53-42020	Double pump双联泵	WA600-3
149	705-51-12090	Double pump双联泵	WA600-8C
150	705-22-40100	Single pump单泵	WA600-3
151	705-23-30610	Single pump单泵	WA600-3
152	705-56-43010	Triple pump三联泵	WA700-1R
153	705-58-43010	Triple pump三联泵	WA800-1
154	705-11-22040	Single pump单泵	WA1200-C

挖掘机 EXCAVATING

挖掘机 EXCAVATING

山推推土机 Shantui bulldozer

山推推土机 Shantui bulldozer

Item No.	Part No.	NOs of Pump	Machine No.
1	705-41-08001	Triple pump三联泵	PC20-6
2	705-86-14000	Triple pump三联泵	PC25-5G PC30-5C
3	705-86-14060	Triple pump三联泵	PC25-5G PC30-5C
4	705-41-08050	Triple pump三联泵	PC25-1E/ PC38UU-2
5	705-41-08080	Triple pump三联泵	PC25-1E/ PC38UU-2
6	705-41-08070	Triple pump三联泵	PC10-7/PC15-3 /PC20-7
7	705-41-02700	Single pump单泵	PC27MR-2/3 PC30MR-2/3
8	705-41-07500	Double pump双联泵	PC35MR
9	705-41-02700	Single pump单泵	PC27MR-2/3 PC30MR-2/3
10	705-41-07180	Single pump单泵	PC35MR-21-3
11	705-41-08100	Triple pump三联泵	PC28UU-2
12	705-41-08210	Triple pump三联泵	PC28/PC30 /PC35
13	705-52-10070	Double pump双联泵	PC30-1R
14	705-56-14000	Triple pump三联泵	PC30-3
15	705-41-07040	Single pump单泵	PC40/PC45/ PC45MR-1
16	705-41-02310	Single pump单泵	PC40/PC45
17	705-54-20000	Double pump双联泵	PC40-1C
18	705-54-20010	Double pump双联泵	PC40-3
19	705-41-08010	Triple pump三联泵	PC40-6 PC20
20	705-41-08090	Triple pump三联泵	PC40-7C/ PC50UU
21	705-41-01620	Single pump单泵	PC50UU
22	705-41-01920	Single pump单泵	PC45R-8R
23	704-24-24400	Single pump单泵	PC60-5C
24	704-24-24430	Single pump单泵	PC60-7C
25	708-3S-04570	Single pump单泵	PC55MR-3
26	705-52-20010	Double pump双联泵	PC60-1

Item No.	Part No.	NOs of Pump	Machine No.
27	705-56-24080	Triple pump三联泵	PC60-3C
28	705-58-24010	Triple pump三联泵	PC60-2R
29	705-21-30251	Single pump单泵	PC75
30	705-22-30150	Single pump单泵	PC75UD-3
31	705-24-29090	Single pump单泵	PC75UU-3 PC78US-5
32	705-40-01370	Single pump单泵	PC75UU-2E
33	705-58-34000	Triple pump三联泵	PC100-3C
34	705-58-34010	Triple pump三联泵	PC100-4C
35	705-56-34000	Triple pump三联泵	PC120-1/2
36	705-56-24090	Triple pump三联泵	PC200-1/2/3/5
37	705-56-24020	Triple pump三联泵	PC200-1
38	705-56-24030	Triple pump三联泵	PC200-1
39	705-51-10020	Double pump双联泵	PC200-2
40	705-51-20110	Double pump双联泵	PC200
41	704-24-26430	Single pump单泵	PC100-6 PC120-6 PC130-6 PC350-6
42	704-24-28203	Single pump单泵	PC200-5
43	704-24-28230	Single pump单泵	PC200-5
44	705-21-26050	Single pump单泵	PC120-1/2
45	704-24-24420	Single pump单泵	PC200-9R
46	705-52-11101	Double pump双联泵	PC600LC-6
47	705-52-21140	Double pump双联泵	PC600-6/7 PC650-6 PC600LC-6
48	705-52-30011	Double pump双联泵	PC650-1
49	705-52-31070	Double pump双联泵	PC750/PC800
50	705-56-34360	Triple pump三联泵	PC1250-C
51	705-51-31060	Double pump双联泵	PC1800-C

Item No.	Part No.	NOs of Pump	Machine No.
1	07421-71401	Single pump单泵	D20-5/6/7/8
2	705-61-28010	Single pump单泵	D20PG-7A
3	103-15-00730	Single pump单泵	D31P-1
4	113-15-00270	Single pump单泵	D31P-1
5	113-15-00470	Single pump单泵	D31P-1
6	14X-12-11102	Single pump单泵	D31P-1
7	705-12-32110	Single pump单泵	D31P-1
8	705-11-33012	Single pump单泵	D31E-17
9	705-11-33013	Single pump单泵	D31E-17
10	705-11-33016	Single pump单泵	D31E-20
11	705-11-20010	Single pump单泵	D31P-17 D31Q-20
12	705-52-21000	Double pump双联泵	D40
13	705-12-32210	Double pump双联泵	D40
14	705-52-21070	Double pump双联泵	D41E-6K
15	705-52-21170 =21070	Double pump双联泵	D41Q-3
16	704-12-38100	Single pump单泵	D50A-16/18 D53
17	07426-71400	Single pump单泵	D50P-16/D50A-17
18	07427-72400	Single pump单泵	D50A-17
19	07429-71203	Single pump单泵	D50/D53/D57
20	07429-72302	Single pump单泵	D50A-17
21	07432-72203	Single pump单泵	D53
22	704-11-38100	Single pump单泵	D53A-16/18 D53P -16/17/18
23	07400-30200	Double pump双联泵	D50P-16/D50A-17
24	07400-40400	Double pump双联泵	D50A-17
25	07400-40500	Double pump双联泵	D50/D60/D70
26	07400-30100	Double pump双联泵	D53/D75-3
27	705-41-01320	Single pump单泵	D60-12/D65-12 /D85-2
28	07443-67503	Single pump单泵	D60/D65
29	07441-67503	Single pump单泵	D60/D65/D70 TY160
30	07430-72203= 07430-72202	Single pump单泵	D60/D65
31	07432-71203	Single pump单泵	D60/D85
32	16Y-75-24000 (07432-71203)	Single pump单泵	D60/D85
33	175-13-23500	Single pump单泵	D60/D85
34	705-51-20800	Double pump双联泵	D65P-12
35	705-51-20930	Double pump双联泵	D65P-12
36	705-51-20830	Double pump双联泵	D65WX-15 D70LE-12

Item No.	Part No.	NOs of Pump	Machine No.
37	14X-49-11600	Single pump单泵	D65-12
38	705-11-34210	Single pump单泵	D65P-12
39	705-11-38240	Single pump单泵	D65/D70/D85
40	705-41-01020	Single pump单泵	D68ESS
41	705-11-36000 /010	Single pump单泵	D68ESS-12
42	705-51-20370	Double pump双联泵	D65WX-15 D70LE-12
43	705-11-40010	Single pump单泵	D70LE-12
44	705-11-38000	Single pump单泵	D70LE-12
45	705-11-38010	Single pump单泵	D70LE-12
46	704-11-40100	Single pump单泵	D75S-1BC
47	07443-67100	Single pump单泵	D75S-2
48	07428-71202	Single pump单泵	D75S-2
49	705-51-30190	Double pump双联泵	D85A-21C
50	705-41-01200	Single pump单泵	D85ESS-1C
51	07436-72202	Single pump单泵	D85A-21/D80A-18
52	07436-72902	Single pump单泵	D85A-21/D80A-18
53	705-41-01540	Single pump单泵	D85ESS-1C
54	705-11-33100	Single pump单泵	D85
55	705-11-34100	Single pump单泵	D85
56	07432-72101	Single pump单泵	D80A-12
57	07433-71103	Single pump单泵	D85/D155-1
58	07434-72201	Single pump单泵	D85/D155-1
59	07444-66101	Single pump单泵	D85/SD22
60	07444-66102	Single pump单泵	D85/SD22
61	07444-66103= 07444-66200	Single pump单泵	D85/SD22
62	705-21-32050	Single pump单泵	D85A-21
63	705-21-32051	Single pump单泵	D85/SD22
64	705-51-30660	Double pump双联泵	D85EX-15
65	705-12-40010	Single pump单泵	D155AX-5
66	705-22-42090	Single pump单泵	D155A-6
67	705-22-43070	Single pump单泵	D155AX-6
68	705-52-40160	Double pump双联泵	D155A-5
69	705-52-40160	Double pump双联泵	D155A-5
70	705-55-34580	Triple pump三联泵	D155AX-5
71	705-55-35000	Triple pump三联泵	D155
72	705-52-30A00	Double pump双联泵	D155-6

山推推土机 Shantui bulldozer 山推推土机 Shantui bulldozer

Item No.	Part No.	NOs of Pump	Machine No.
73	705-52-22100	Double pump双联泵	D155A-2A
74	705-51-30240	Double pump双联泵	D135A-1
75	07440-72202	Single pump单泵	D150/D155A-1
76	07446-66102	Single pump单泵	D155A-1
77	07446-66103	Single pump单泵	D155A-1
78	07446-66200	Single pump单泵	D155A-1
79	07436-66102	Single pump单泵	D155
80	705-51-30290	Double pump双联泵	D155AX-3
81	705-51-30360	Double pump双联泵	D155AX-3
82	195-49-34100	Double pump双联泵	D275A-2
83	705-95-05140	Double pump双联泵	D275A-2/D375A-1/3
84	705-52-30250	Double pump双联泵	D275AX-5
85	705-52-30920	Double pump双联泵	D275AX-5
86	705-12-41010	Single pump单泵	D355/D375/D405
87	07448-66102	Single pump单泵	D355A-3
88	07448-66107	Single pump单泵	D355A-3
89	07448-66108	Single pump单泵	D355A-3
90	07448-66200	Single pump单泵	D355A-3
91	07448-66500	Single pump单泵	D355A-3
92	07448-66803	Single pump单泵	D355A-3
93	07434-72202	Single pump单泵	D355C-1C/WA470
94	07434-72902	Single pump单泵	D355C-1C/WA470
95	07438-72202	Single pump单泵	D355A-3
96	07438-72902	Single pump单泵	D355A-3
97	07442-71102	Single pump单泵	D355A-3
98	07442-71802	Single pump单泵	D355A-5
99	07442-72202	Single pump单泵	D455/D355A-3/5 D475
100	705-12-43030	Single pump单泵	D455A-1C
101	705-52-40000	Double pump双联泵	D375A-2
102	705-52-40001	Double pump双联泵	D375A-2
103	705-52-40080	Double pump双联泵	D375A-2
104	705-52-40081	Double pump双联泵	D375A-2
105	705-52-40100	Double pump双联泵	D375A-2
106	705-58-44050	Triple pump三联泵	D375A-3/5
107	705-52-40250	Double pump双联泵	D475A-3
108	705-52-40290	Double pump双联泵	D475A-3

Item No.	Part No.	NOs of Pump	Machine No.
109	705-52-42000	Double pump双联泵	D475A-2
110	705-52-42001	Double pump双联泵	D475A-2
111	705-52-42010	Double pump双联泵	D575A
112	705-52-42110	Double pump双联泵	D475A-2
113	705-52-42170	Double pump双联泵	D475A-2
114	705-52-30170-2/S	Double pump双联泵	D475A-2
115	705-52-30240	Double pump双联泵	D475A-2
116	705-52-30580	Double pump双联泵	D475A-3
117	705-52-30810	Double pump双联泵	D475A-3
118	705-21-43000	Single pump单泵	D475A-1/2
119	705-21-43010	Single pump单泵	D475A-1/2
120	705-21-46020	Single pump单泵	D475A2
121	705-22-48010	Single pump单泵	D575A-2C
122	705-58-44000	Triple pump三联泵	D575A-2C
123	705-51-42050	Double pump双联泵	D575A-2C
124	705-51-42060	Double pump双联泵	D575A-2C
125	705-51-42070	Double pump双联泵	D575A-2
126	705-51-42080	Double pump双联泵	D575A-2C
127	705-22-48010	Single pump单泵	D575A-2C
128	704-71-44002	Double pump双联泵	D375A-1/2/3
129	704-71-44011	Double pump双联泵	D475-1S/N
130	704-71-44012	Double pump双联泵	D475-2S/N
131	704-71-44030	Double pump双联泵	D275-3S
132	704-71-44050	Triple pump三联泵	D475A-3SC
133	704-71-44060	Double pump双联泵	D375-5R
134	704-71-44071	Triple pump三联泵	D475A-5SD
135	704-72-44000	Double pump双联泵	D475A-6C

自卸车 Dump truck

Item No.	Part No.	NOs of Pump	Machine No.
1	07439-66103	Single pump单泵	HD325
2	705-11-23010	Single pump单泵	HD205/HD255/HD320/HD325/HD405/HD465
3	705-12-38000	Single pump单泵	HD325-6
4	705-12-38010	Single pump单泵	HD325-6
5	705-12-38211	Single pump单泵	HD465/HD605
6	705-22-38050	Single pump单泵	HD325-6
7	705-22-40110	Single pump单泵	HM400-1 WA500-1
8	705-22-44020	Single pump单泵	HD785-3/5 HD985-3/5
9	705-41-02630	Single pump单泵	HP500-7R
10	705-41-07051	Double pump双联泵	HM400-2
11	705-51-42010	Double pump双联泵	HD785-2
12	705-52-20070	Double pump双联泵	HD255
13	705-52-20090	Double pump双联泵	HD205-3
14	705-52-22000	Double pump双联泵	HD205-3
15	705-52-30040	Double pump双联泵	HD255-5
16	705-52-30050	Double pump双联泵	HD325-5
17	705-52-30290	Double pump双联泵	HD255-5
18	705-52-30360	Double pump双联泵	HD255-5C
19	705-52-31010	Double pump双联泵	HD465-7
20	705-52-31150	Double pump双联泵	HM400-1C
21	705-52-31170	Double pump双联泵	HD465-7
22	705-52-31180	Double pump双联泵	HM300-1
23	705-52-31210	Double pump双联泵	HM350-1
24	705-52-31250	Double pump双联泵	HM300-1
25	705-52-32000	Double pump双联泵	HD465-3/5 HD605-5
26	705-52-42090	Double pump双联泵	HD785-3
27	705-52-42100	Double pump双联泵	HD785-3
28	705-52-42220	Double pump双联泵	HD785-3
29	705-56-31040	Triple gear pump三联泵	HM300/HM350
30	705-56-33040	Triple gear pump三联泵	HM400-1C
31	705-56-33050	Triple gear pump三联泵	HM350-1
32	705-56-33080	Triple gear pump三联泵	HM400-1C
33	705-56-33140	Quadruple pump四联泵	HM400-3S/N
34	705-56-34450	Triple gear pump三联泵	HM300-1
35	705-56-34490	Triple gear pump三联泵	HM400-1
36	705-56-34590	Triple gear pump三联泵	HM350-1
37	705-56-34630	Triple gear pump三联泵	HD465-7
38	705-56-44090	Triple gear pump三联泵	HM350-1/HD785-7
39	705-95-03020	Double pump双联泵	HD465-0C
40	705-95-07100	Triple gear pump三联泵	HD465-0C

平地机 GRADER

Item No.	Part No.	NOs of Pump	Machine No.
1	23A-40-11400	Single pump单泵	Gd505
2	23A-60-11200	Single pump单泵	GD611A-1
3	23B-60-11100	Double pump双联泵	GD621A-1/GD611A-1/GD605A-5/GD521A-1/GD623A-1
4	704-56-11101	Double pump双联泵	GD611
5	704-56-11101	Double pump双联泵	GD611
6	705-11-28010	Single pump单泵	D155AX-3/D20A-5 HD785/HD985/WA40-1
7	705-11-33014	Single pump单泵	GD505A-2
8	705-11-33015	Single pump单泵	GD505A-C
9	705-12-28010	Single pump单泵	GD330
10	705-12-34010	Single pump单泵	GD705A1C
11	705-12-34060	Single pump单泵	GD705A2C
12	705-12-35010	Single pump单泵	GD605/GD705
13	705-22-36260	Single pump单泵	GD555-3A
14	705-22-36460	Single pump单泵	GD675-5
15	705-24-30010	Single pump单泵	GD705A-3/4
16	705-24-30060	Single pump单泵	GD705A-3/4
17	705-52-10001	Double pump双联泵	GD605A-3
18	705-52-10030	Double pump双联泵	GD505
19	705-52-10050	Double pump双联泵	GD505A-2
20	705-52-20160	Double pump双联泵	GD705A-4
21	705-52-21160	Double pump双联泵	GD400
22	705-52-21250	Double pump双联泵	GD675-5SN
23	705-56-24370	Triple pump三联泵	GD705-5
24	705-58-24120	Triple pump三联泵	GD675-2C
25	705-52-31220	Double pump双联泵	GD755-5R/GD755-3

起重机 CRANE

Item No.	Part No.	NOs of Pump	Machine No.
1	07439-66103	Single pump单泵	LW200-1
2	705-11-23010	Single pump单泵	LW200-1
3	705-12-38000	Single pump单泵	LW200-1
4	705-12-38010	Single pump单泵	LW250-1
5	705-12-38211	Single pump单泵	LW100-1H
6	705-22-38050	Single pump单泵	LW250-1
7	705-22-40110	Single pump单泵	LW250
8	705-22-44020	Single pump单泵	LW100-1
9	705-41-02630	Single pump单泵	LW250L-C
10	705-41-07051	Double pump双联泵	LW250-5
11	705-51-42010	Double pump双联泵	LW250-0C
12	705-52-20070	Double pump双联泵	LW250L-1NH

其他 OTHER

Item No.	Part No.	NOs of Pump	Machine No.
1	K3V112	Double SK200 SK220	川崎先导泵
2	K3V140	SK300 HD1200	川崎先导泵
3	9218993 4181700	EX200-1 EX300-1	日立先导泵
4	9218005 4276918	EX200-3(5) EX100-3(5)	日立先导泵
5	9218004 4255303	EX100-2 EX200-2 120-2	日立先导泵
6	27E	SWE 45/50/60/65/70	KYB
7	21E		KYB

Item No.	Part No.	Part No.	Part No.
1	CBHZ-F32-ALH6	CBHZA-F36-AFΦL	KRP4-23CDHD
2	CBHZ-F32-ALΦ	GP2-F20-TTBL	IP3084AKK
3	CBHZ-F36-ALΦL	CBW-F314-CFB	KRP4-23ASBSL
4	CBHZ-F40-ALΦ13L	CBHYa-G36/F3.5-ATΦ	
5	W3-20T	CBHZA-F28.2-AFΦ10	
6	CBHZA-F25-ATΦ10	SYQLZ-F528/F528-AFΦ	
7	SGP1-F25-ATΦ10L	CBTSL-F416/F416/F412-AFΦ	
8	CBT-F423-AL8Φ11L	CBQLQ-F540/F540-CFH	
9	CBWZT-F320-AFΦ		

转向器 STEERING

Item No.	Part No.	Part No.
1	BZZ1-100A	BZZ1-400B
2	BZZ1-100B	BZZ1-400C
3	BZZ1-100C	BZZ5-400B
4	BZZ1-160A	BZZ1-500A
5	BZZ1-160B	BZZ1-500B
6	BZZ1-160C	BZZ1-500C
7	BZZ1-125A	BZZ5-500B
8	BZZ1-125B	BZZ1-630A
9	BZZ1-125C	BZZ1-630B
10	BZZ1-200A	BZZ1-630C
11	BZZ1-200B	BZZ5-630B
12	BZZ1-200C	BZZ1-800A
13	BZZ5-200B	BZZ1-800C
14	BZZ1-250A	BZZ1-800B
15	BZZ1-250B	BZZ5-800B
16	BZZ1-250C	BZZ1-1000A
17	BZZ1-350A	BZZ1-1000C
18	BZZ1-350B	BZZ1-1000B
19	BZZ1-350C	BZZ5-1000B
20	BZZ1-400A	



马达 THE MOTOR

Item No.	Part No.	Part No.	Part No.
1	BMM8-50	BMP36	BMPW 36
2	BMP36-400	BMP50	BMPW 50
3	BMR36-375	BMP80	BMPW 80
4	BMH200-500	BMP100	BMPW 100
5	BM2-125-400	BMP125	BMPW 125
6	BM3-500-630	BMP160	BMPW 160
7	BMM8	BMP200	BMPW 200
8	BMM12.5	BMP250	BMPW 250
9	BMM20	BMM40	BMPW 315
10	BMM32	BMM50	BMPW 400
11	BMS 80	BMSE-80	BMSZ-80
12	BMS 100	BMSE-100	BMSZ-100
13	BMS 125	BMSE-125	BMSZ-125
14	BMS 160	BMSE-160	BMSZ-160
15	BMS 200	BMSE-200	BMSZ-200
16	BMS 250	BMSE-250	BMSZ-250
17	BMS 315	BMSE-315	BMSZ-315
18	BMS 375	BMSE-375	BMSZ-375
19	BMRS 36	BMT 160	BMV 315
20	BMRS 50	BMT 200	BMV 400
21	BMRS 80	BMT 250	BMV 500
22	BMRS 100	BMT 315	BMV 630
23	BMRS 125	BMT 400	BMV 800
24	BMRS 160	BMT 500	BMV 1000
25	BMRS 200	BMT 630	
26	BMRS 250	BMT 800	
27	BMRS 315		
28	BMRS 375		

Item No.	Part No.	Machine No.
1	PVD-1B-4	PC30 PC40 35MR-1
2	PVD-2B-4	PC55 PC56-7
3	PVD-2B-2	50
4	PVD-0B-18/24P	35
5	PVD 15A	PC50UU-2
6	PVD 15	PC40-1 PC45
7	PVD8.5-4	PC27MR-2

<p>YEM-H6864</p>  <p>小松 PC200-7 Ls 阀 708-2L-06710</p>	<p>YEM-H6865</p>  <p>小松 PC220-7 LS 阀 708-2L-35311</p>	<p>YEM-H6866</p>  <p>小松 PC200 备用阀侧阀 723-46-48100</p>	<p>YEM-H6867</p>  <p>小松 PC 压力补偿阀 (带单向阀) 423-46-43200</p>
<p>YEM-H6868</p>  <p>PC200-3 付炮 709-70-55100</p>	<p>YEM-H6869</p>  <p>小松 PC120-6 动作阀 709-90-73100</p>	<p>YEM-H6870</p>  <p>小松 PC120-6 提升阀 709-90-73100</p>	<p>YEM-H6871</p>  <p>小松 PC200-6 (6D102) 主炮 723-40-51102</p>
<p>YEM-H6872</p>  <p>小松 PC60-5 主炮 709-20-51800</p>	<p>YEM-H6873</p>  <p>小松 PC60-7 主炮 709-20-51800</p>	<p>YEM-H6874</p>  <p>小松 PC60-7 付炮</p>	<p>YEM-H6875</p>  <p>小松 PC60-7 回转</p>
<p>YEM-H6876</p>  <p>小松 PC60-7 卸荷阀</p>	<p>YEM-H6877</p>  <p>小松 PC60 回转</p>	<p>YEM-H6878</p>  <p>小松 PC100-5 付炮 709-70-55100</p>	<p>YEM-H6879</p>  <p>小松 PC120-5 付炮 709-70-55100</p>
<p>YEM-H6880</p>  <p>小松 PC120-5 主炮 709-70-51200</p>	<p>YEM-H6881</p>  <p>小松 PC120-6 卸荷阀 723-30-56100</p>	<p>YEM-H6882</p>  <p>小松 PC120-7 卸荷阀 723-30-56100</p>	<p>YEM-H6883</p>  <p>小松 PC120 行走阀</p>
<p>YEM-H6884</p>  <p>小松 PC200-5 主炮 709-70-51401</p>	<p>YEM-H6885</p>  <p>小松 PC200-6 主炮 (山推) 723-40-93601</p>	<p>YEM-H6886</p>  <p>小松 PC200-6 主炮 (手拉油门) 723-40-93601</p>	<p>YEM-H6887</p>  <p>小松 PC200-6 (6D102) 主炮 723-40-51102</p>

主炮、副炮 MAIN VALVE/SERVICE VALVE

<p>YEM-H6888</p>  <p>小松PC130-7吸油阀 709-90-73100</p>	<p>YEM-H6889</p>  <p>小松PC200-3付炮 709-70-55100</p>	<p>YEM-H6890</p>  <p>小松PC200-3先导阀 702-75-01201</p>	<p>YEM-H6891</p>  <p>小松PC200-3主炮 709-70-51200</p>
<p>YEM-H6892</p>  <p>小松PC200-7付炮 723-46-42800</p>	<p>YEM-H6893</p>  <p>小松PC200-7备用阀 723-40-90101</p>	<p>YEM-H6894</p>  <p>小松PC200-8付炮 723-40-91300</p>	<p>YEM-H6895</p>  <p>小松PC220-8主炮 723-40-51100</p>
<p>YEM-H6896</p>  <p>小松PC240主炮 723-40-51100</p>	<p>YEM-H6897</p>  <p>小松PC270-8主炮 723-40-92103</p>	<p>YEM-H6898</p>  <p>小松PC360-7主炮 723-40-92403</p>	<p>YEM-H6899</p>  <p>小松PC400-7主炮 723-40-93600</p>
<p>YEM-H6900</p>  <p>日立EX-1主炮 4242176</p>	<p>YEM-H6901</p>  <p>日立EX-2付炮 4242176</p>	<p>YEM-H6902</p>  <p>日立EX-2回转</p>	<p>YEM-H6903</p>  <p>日立EX70主炮</p>
<p>YEM-H6904</p>  <p>日立EX100-5回转</p>	<p>YEM-H6905</p>  <p>日立EX120-2主炮 9185757</p>	<p>YEM-H6906</p>  <p>日立EX120-3主炮 9185757</p>	<p>YEM-H6907</p>  <p>日立EX120-5回转</p>
<p>YEM-H6908</p>  <p>日立EX240-5主炮 4372038</p>	<p>YEM-H6909</p>  <p>日立EX300-1回转</p>	<p>YEM-H6910</p>  <p>日立EX330行走阀</p>	<p>YEM-H6911</p>  <p>日立ZAX55主炮</p>

主炮、副炮 MAIN VALVE/SERVICE VALVE

<p>YEM-H6912</p>  <p>日立EX120付炮</p>	<p>YEM-H6913</p>  <p>日立EX200-2主炮 4289604</p>	<p>YEM-H6914</p>  <p>日立EX200-5回转 YN22V00014F1</p>	<p>YEM-H6915</p>  <p>日立EX200-5主炮 4372038</p>
<p>YEM-H6916</p>  <p>日立ZAX70主炮</p>	<p>YEM-H6917</p>  <p>日立ZAX330行走阀</p>	<p>YEM-H6918</p>  <p>日立ZAX330主炮 320-350-100</p>	<p>YEM-H6919</p>  <p>大宇DH55付炮</p>
<p>YEM-H6920</p>  <p>大宇DH60主炮</p>	<p>YEM-H6921</p>  <p>大宇DH80付炮</p>	<p>YEM-H6922</p>  <p>大宇DH80主炮</p>	<p>YEM-H6923</p>  <p>大宇DH130-8付炮</p>
<p>YEM-H6924</p>  <p>大宇DH55回转</p>	<p>YEM-H6925</p>  <p>大宇DH55主炮</p>	<p>YEM-H6926</p>  <p>大宇DH60付炮</p>	<p>YEM-H6927</p>  <p>大宇DH60回转</p>
<p>YEM-H6928</p>  <p>大宇DH150-7付炮</p>	<p>YEM-H6929</p>  <p>大宇DH220-7主炮 14513267</p>	<p>YEM-H6930</p>  <p>大宇DH225-7回转 YN22V00014F1</p>	<p>YEM-H6931</p>  <p>大宇DH225-7主炮 4372038</p>
<p>YEM-H6932</p>  <p>斗山55付炮</p>	<p>YEM-H6933</p>  <p>斗山55主炮</p>	<p>YEM-H6934</p>  <p>斗山60回转</p>	<p>YEM-H6935</p>  <p>加藤HD80主炮</p>

主炮、副炮 MAIN VALVE/SERVICE VALVE

<p>YEM-H6936</p>  <p>加藤HD400主炮</p>	<p>YEM-H6937</p>  <p>加藤HD450主炮</p>	<p>YEM-H6938</p>  <p>加藤HD700-7主炮</p>	<p>YEM-H6939</p>  <p>加藤HD700-800回转</p>
<p>YEM-H6940</p>  <p>加藤HD800-900主炮 32642101</p>	<p>YEM-H6941</p>  <p>加藤HD820-3回转 YN22V00014F1</p>	<p>YEM-H6942</p>  <p>加藤HD820主炮 14513267</p>	<p>YEM-H6943</p>  <p>加藤HD1430主炮 2113-50306</p>
<p>YEM-H6944</p>  <p>加藤HD250付炮</p>	<p>YEM-H6945</p>  <p>加藤HD250回转</p>	<p>YEM-H6946</p>  <p>加藤HD250主炮</p>	<p>YEM-H6947</p>  <p>加藤HD300-400回转</p>
<p>YEM-H6948</p>  <p>卡特E307主炮</p>	<p>YEM-H6949</p>  <p>卡特E320B付炮</p>	<p>YEM-H6950</p>  <p>卡特E320C主炮</p>	<p>YEM-H6951</p>  <p>卡特E320C主炮</p>
<p>YEM-H6952</p>  <p>卡特E320B付炮</p>	<p>YEM-H6953</p>  <p>卡特E320D主炮 6E-5933</p>	<p>YEM-H6954</p>  <p>卡特E320行走阀</p>	<p>YEM-H6955</p>  <p>卡特E320回转</p>
<p>YEM-H6956</p>  <p>卡特CAT单向阀</p>	<p>YEM-H6957</p>  <p>卡特E200B回转</p>	<p>YEM-H6958</p>  <p>卡特E200B主炮</p>	<p>YEM-H6959</p>  <p>卡特E307D主炮</p>

主炮、副炮 MAIN VALVE/SERVICE VALVE

<p>YEM-H6960</p>  <p>卡特E323主炮</p>	<p>YEM-H6961</p>  <p>神钢SK60-7主炮</p>	<p>YEM-H6962</p>  <p>神钢SK60主炮</p>	<p>YEM-H6963</p>  <p>神钢SK75卸荷阀</p>
<p>YEM-H6964</p>  <p>神钢SK100-5主炮</p>	<p>YEM-H6965</p>  <p>神钢SK110-5主炮</p>	<p>YEM-H6966</p>  <p>神钢SK130-5主炮 323-350-100</p>	<p>YEM-H6967</p>  <p>神钢SK200-1付炮</p>
<p>YEM-H6968</p>  <p>神钢SK200-1主炮</p>	<p>YEM-H6969</p>  <p>神钢SK200-3付炮</p>	<p>YEM-H6970</p>  <p>神钢SK200-3主炮</p>	<p>YEM-H6971</p>  <p>神钢SK200-5-6主炮 320-350-100</p>
<p>YEM-H6972</p>  <p>神钢SK200-5付炮</p>	<p>YEM-H6973</p>  <p>神钢SK200-8付炮</p>	<p>YEM-H6974</p>  <p>神钢SK200-8回转 YN22V00013F1</p>	<p>YEM-H6975</p>  <p>神钢SK200-8主炮 320-350-100</p>
<p>YEM-H6976</p>  <p>神钢SK单向阀</p>	<p>YEM-H6977</p>  <p>沃尔沃210主炮 14513267</p>	<p>YEM-H6978</p>  <p>沃尔沃240主炮</p>	<p>YEM-H6979</p>  <p>现代R60回转</p>
<p>YEM-H6980</p>  <p>现代R225-7行走</p>	<p>YEM-H6981</p>  <p>住友SH200A1/A2主炮 32642101</p>	<p>YEM-H6982</p>  <p>住友SH70回转</p>	<p>YEM-H6983</p>  <p>住友SH120付炮</p>

主炮、副炮 MAIN VALVE/SERVICE VALVE

单向阀 CHECK VALVE

<p>YEM-H6984</p>  <p>住友SH200A1/A2 32642101</p>	<p>YEM-H6985</p>  <p>工业阀</p>	<p>YEM-H6986</p>  <p>工业阀</p>	<p>YEM-H6987</p>  <p>力士乐付炮</p>
<p>YEM-H6988</p>  <p>力士乐主炮</p>	<p>YEM-H6989</p>  <p>三一75主炮</p>	<p>YEM-H6990</p>  <p>三一215-8付炮</p>	<p>YEM-H6991</p>  <p>三一215-8主炮</p>
<p>YEM-H6992</p>  <p>三一225-8主炮</p>	<p>YEM-H6993</p>  <p>山河智能70主炮</p>	<p>YEM-H6994</p>  <p>玉柴YC85卸荷阀</p>	<p>YEM-H6995</p>  <p>玉柴吸油阀</p>
<p>YEM-H6996</p>  <p>龙工907主炮</p>	<p>YEM-H6997</p>  <p>派克280主炮</p>	<p>YEM-H6998</p>  <p>大宇单向阀</p>	
<p>YEM-H6999</p>  <p>小松PC200-7自减阀 723-40-71103</p>	<p>YEM-H7000</p>  <p>小松PC120-6自减阀 702-21-09147</p>	<p>YEM-H7001</p>  <p>小松PC200-6自减阀</p>	<p>YEM-H7002</p>  <p>小松PC</p>

<p>YEM-H7003</p>  <p>SH120单向阀 KRJ1600 11.6X8.7</p>	<p>YEM-H7004</p>  <p>SH460单向阀 KTJ2038 16.7X15</p>	<p>YEM-H7005</p>  <p>SH350-5单向阀 2.0 KTJ2038 9.6X3.9</p>
<p>YEM-H7006</p>  <p>SH单向阀 3.0 12.5X5</p>	<p>YEM-H7007</p>  <p>SH200/SH300单向阀 KRJ2246 12.5X11.5</p>	<p>YEM-H7008</p>  <p>SH460-5单向阀 4.0 12.5X5</p>
<p>YEM-H7009</p>  <p>SH单向阀 1.0 9.6X4</p>	<p>YEM-H7010</p>  <p>SK 单向阀 5.0 14.5X4.2</p>	<p>YEM-H7011</p>  <p>SK75单向阀 YR21V0001R1 8.6X5.8</p>
<p>YEM-H7012</p>  <p>SK2.5单向阀 14.5X4.2</p>	<p>YEM-H7013</p>  <p>SK460单向阀 1.5 LV21V00003F4 19.5X6</p>	<p>YEM-H7014</p>  <p>E320C/D单向阀 4.0 12.5X4.8</p>
<p>YEM-H7015</p>  <p>E320C/D单向阀 3.0 12.5X4.8</p>	<p>YEM-H7016</p>  <p>三一 4.5 单向阀 12.5X5</p>	<p>YEM-H7017</p>  <p>三一 2.5 单向阀 12.5X5</p>
<p>YEM-H7018</p>  <p>厦工4.5单向阀 12.5X5</p>	<p>YEM-H7019</p>  <p>厦工2.5单向阀 12.5X5</p>	<p>YEM-H7020</p>  <p>HD1250单向阀 2.5压力 12.5X5</p>
<p>YEM-H7021</p>  <p>HD1250单向阀 4.5压力 12.5X5</p>	<p>YEM-H7022</p>  <p>徐工单向阀 2.0 19.8X6</p>	<p>YEM-H7023</p>  <p>徐工单向阀 5.0 19.8X6</p>

单向阀 CHECK VALVE

<p>YEM-H7024</p>  <p>SK 单向阀2.5 YN21V00013F1</p>	<p>YEM-H7025</p>  <p>4387143 单向阀4.0 ZX330</p>	<p>YEM-H7026</p>  <p>432456-467480 单向阀1.5 ZX330/ZX330-3</p>
<p>YEM-H7027</p>  <p>KRJ32823 单向阀1.0 SH210-5</p>	<p>YEM-H7028</p>  <p>KRJ3515 单向阀3.0 SH210-5</p>	<p>YEM-H7029</p>  <p>VA12009A002A 单向阀4.5 三一重工</p>
<p>YEM-H7030</p>  <p>VA12005A004A 单向阀2.5 三一重工</p>	<p>YEM-H7031</p>  <p>177-2713 单向阀4.0 E320C</p>	<p>YEM-H7032</p>  <p>184-3833 单向阀3.0 E320C</p>
<p>YEM-H7033</p>  <p>VA16004A003A 单向阀5.0 徐工/SK460</p>	<p>YEM-H7034</p>  <p>VA16004A003R 单向阀2.0 徐工</p>	<p>YEM-H7035</p>  <p>LV12-45T 单向阀4.5 厦工</p>
<p>YEM-H7036</p>  <p>LV12-25T 单向阀2.5 厦工</p>	<p>YEM-H7037</p>  <p>单向阀5.0 SK</p>	<p>YEM-H7038</p>  <p>4276584 单向阀1.0 ZX200/ZX200-3/ZX240 -3ZX230/ZX240</p>
<p>YEM-H7039</p>  <p>410128-00063 单向阀2.5 DH</p>	<p>YEM-H7040</p>  <p>410128-00055 单向阀4.5 DH</p>	<p>YEM-H7041</p>  <p>410128-00043 单向阀3.0 DH</p>
<p>YEM-H7042</p>  <p>HD820 5.0压力 669-50700002 回油单向阀</p>	<p>YEM-H7043</p>  <p>410128-00033 3.0K 单向阀</p>	<p>YEM-H7044</p>  <p>410128-00049 1.5K 单向阀</p>

单向阀 CHECK VALVE

<p>YEM-H7045</p>  <p>410128-00034 单向阀1.0 DH</p>	<p>YEM-H7046</p>  <p>410128-00033 单向阀3.0 DH</p>	<p>YEM-H7047</p>  <p>410128-00049 单向阀1.5 DH</p>
<p>YEM-H7048</p>  <p>4276584 单向阀1.0 ZX200/ZX200-3/ ZX240-3ZX230/ZX240</p>	<p>YEM-H7049</p>  <p>KHJ16030 单向阀2.0 SH350-5</p>	<p>YEM-H7050</p>  <p>KHJ19730 单向阀4.0 SH460-5</p>
<p>YEM-H7051</p>  <p>4436022 单向阀2.5 ZX450</p>	<p>YEM-H7052</p>  <p>4277666 单向阀1.5 ZX450</p>	<p>YEM-H7053</p>  <p>14673207 单向阀4.5 VOLVO</p>
<p>YEM-H7054</p>  <p>14673207 单向阀3.0 VOLVO</p>	<p>YEM-H7055</p>  <p>12C1518 单向阀 柳工</p>	<p>YEM-H7056</p>  <p>12C2503 单向阀 柳工</p>
<p>YEM-H7057</p>  <p>12C0154 单向阀 柳工225</p>	<p>YEM-H7058</p>  <p>4656988 单向阀5.0 ZX200-3/240/330-3</p>	<p>YEM-H7059</p>  <p>4272164 单向阀 ZX200/230/240</p>
<p>YEM-H7060</p>  <p>DH60 液压油箱单向阀 8.6X6.7</p>	<p>YEM-H7061</p>  <p>DH60 单向阀 3.0压力 410128-00033 9.8X3.7</p>	<p>YEM-H7062</p>  <p>DH60 单向阀 1.5压力 410128-00049</p>
<p>YEM-H7063</p>  <p>DH 单向阀 1.0 12.5X4.8</p>	<p>YEM-H7064</p>  <p>柳工12C2503 单向阀 19.5X5.6</p>	<p>YEM-H7065</p>  <p>柳工225 单向阀 12C0154 14X4.3</p>

单向阀 CHECK VALVE

<p>YEM-H7066</p>  <p>柳工12C1518单向阀 15.5X5.5</p>	<p>YEM-H7067</p>  <p>VOLVO单向阀 14673207 3.0 14.4X4.2</p>	<p>YEM-H7068</p>  <p>VOLVO单向阀 4.5 14673207 14.4X4.2</p>
<p>YEM-H7069</p>  <p>小松/山推单向阀 8.4X3.8</p>	<p>YEM-H7070</p>  <p>小松/山推 单向阀 11.7X9</p>	<p>YEM-H7071</p>  <p>PC300-7/8单向阀 2.5压力 12.1X12.5</p>
<p>YEM-H7072</p>  <p>PC200-7/8单向阀 11.5X12.5</p>	<p>YEM-H7073</p>  <p>20T液压油箱单向阀 10.8X12.5</p>	<p>YEM-H7074</p>  <p>小松/山推单向阀 9.1X6.8</p>
<p>YEM-H7075</p>  <p>ZAX450单向阀 4436022 2.5 19.6X7</p>	<p>YEM-H7076</p>  <p>ZAX330/330-3单向阀 1.5压力 14.5X4.2</p>	<p>YEM-H7077</p>  <p>ZAX200-3/240-3/330-3单向阀 4656988 5.0压力 14.4X3.4</p>
<p>YEM-H7078</p>  <p>ZAX330单向阀 4.0压力 14.5X4.2</p>	<p>YEM-H7079</p>  <p>ZAX450单向阀 4277666 1.5 12.6X5</p>	<p>YEM-H7080</p>  <p>ZAX240-3单向阀 电喷1.5 12.5X4.2</p>
<p>YEM-H7081</p>  <p>ZAX200单向阀 4272164 14.4X3.4</p>	<p>YEM-H7082</p>  <p>EX直喷单向阀 1.0 9.6X4.2</p>	<p>YEM-H7083</p>  <p>ZAX240-3单向阀 电喷4.0 12.5X4.2</p>
<p>YEM-H7084</p>  <p>DH 4.5单向阀 410128-00055 13X4.8</p>	<p>YEM-H7085</p>  <p>DH2.5单向阀 19.8X6</p>	<p>YEM-H7086</p>  <p>DH3.0单向阀 12.5X4.8</p>

单向阀 CHECK VALVE

<p>YEM-H7087</p>  <p>单向阀PC200-7/8</p>	<p>YEM-H7088</p>  <p>单向阀 2.5 PC300-7/8</p>	<p>YEM-H7089</p>  <p>Kr12246 单向阀 SH330A3</p>
<p>YEM-H7090</p>  <p>KTJ20378单向阀 SH450A5/460</p>	<p>YEM-H7091</p>  <p>KRJ1600单向阀 SH120/SH75X-3B</p>	<p>YEM-H7092</p>  <p>YR21V0001R1单向阀 Sk75</p>
<p>YEM-H7093</p>  <p>R335-7单向阀 1.5压力 12.5x4.8</p>	<p>YEM-H7094</p>  <p>R335-7单向阀 3.0压力 12.5x4.8</p>	<p>YEM-H7095</p>  <p>单向阀R60/R80</p>
<p>YEM-H7096</p>  <p>35M5-00240 单向阀 R200/R300</p>	<p>YEM-H7097</p>  <p>LV21V00003F4 单向阀1.5 SK460</p>	<p>YEM-H7098</p>  <p>31Q6-11110 单向阀1.5 HYUNDAI</p>
<p>YEM-H7099</p>  <p>31ER-11111单向阀总成1.5 R225-7/150-7/305-7/210W-5110-9 /150-9/110-7/205-7/215-7</p>	<p>YEM-H7100</p>  <p>31ER-11121单向阀总成3.0 R305-7/225-7/210W-5/150W-9/ 215-9/215-9C/225-9/305-9/ 335-9/150W-7/205-7/210W-7/ 215-7/215-7C/245-7/265-7/ 225-9T/305-9T/335-9T</p>	<p>YEM-H7101</p>  <p>31Q6-12290单向阀总成5.0 R305-7/455-7/210W-7/ 245-7/265-7/335-7/375-7</p>

单向阀 CHECK VALVE

摩擦片 FRICTION PLATE

<p>YEM-H7102</p>  <p>12C1903 单向阀总成 柳工</p>	<p>YEM-H7103</p>  <p>12C2503 单向阀总成 柳工</p>	<p>YEM-H7104</p>  <p>12C5250 单向阀总成 柳工</p>	<p>YEM-H7105</p>  <p>12C1518A 单向阀总成 柳工225</p>
<p>YEM-H7106</p>  <p>柳工12C2289单向阀总成</p>	<p>YEM-H7107</p>  <p>柳工12C1518 回油单向阀总成</p>	<p>YEM-H7108</p>  <p>柳工12C1903单向阀总成</p>	<p>YEM-H7109</p>  <p>柳工12C2503单向阀总成</p>
<p>YEM-H7110</p>  <p>14555660 单向阀4.5 VOLVO360</p>	<p>YEM-H7111</p>  <p>14555660 单向阀3.0 VOLVO360</p>	<p>YEM-H7112</p>  <p>现代3.0单向阀总成 E131-0116 13.5X7</p>	<p>YEM-H7113</p>  <p>现代1.5压力单向阀 E313-0115</p>
<p>YEM-H7114</p>  <p>现代31NB-12520 5.0K压力回油单向阀总成</p>	<p>YEM-H7115</p>  <p>现代31ND-11110 1.5K压力回油单向阀总成</p>	<p>YEM-H7116</p>  <p>31ND-11120 单向阀3.0 HYUNDAI</p>	<p>YEM-H7117</p>  <p>31EH-11160 单向阀 HYUNDAI</p>
<p>YEM-H7118</p>  <p>31EH-11150 单向阀1.5 HYUNDAI</p>	<p>YEM-H7119</p>  <p>31NB-12520 单向阀 5.0 HYUNDAI</p>	<p>YEM-H7120</p>  <p>31ND-11110 单向阀1.5 HYUNDAI</p>	<p>YEM-H7121</p>  <p>现代31EH-11160 3.0K压力回油单向阀总成</p>

<p>YEM-H7122</p>  <p>ALLISON 6768446 253.7x187.5x3.9 60T</p>	<p>YEM-H7123</p>  <p>ALLISON 6777592 253.7x74.4x3.9</p>	<p>YEM-H7124</p>  <p>ALLISON 6835720 275.3x213.4x3.2 50T</p>	<p>YEM-H7125</p>  <p>ALLISON 23016608 292.1x224.3x2.5 11T</p>	<p>YEM-H7126</p>  <p>ALLISON 23041615 433.3x371.3x5.2 89T</p>
<p>YEM-H7127</p>  <p>ALLISON 23041616 371.3x303.0x5.2 72T</p>	<p>YEM-H7128</p>  <p>ALLISON 23041786 319.0x259.1x3.8 62T</p>	<p>YEM-H7129</p>  <p>ALLISON 23042200 182.4x129.5x2.5 30T</p>	<p>YEM-H7130</p>  <p>ALLISON 23046108 314.5x230.9x3.5 56T</p>	<p>YEM-H7131</p>  <p>CASE 100049A1 455.0x342.0x4.0 142T</p>
<p>YEM-H7132</p>  <p>CASE 100050A1 437.9x325.1x5.3 104T</p>	<p>YEM-H7133</p>  <p>CASE 237017A1 272.0x71.1x4.9 36T</p>	<p>YEM-H7134</p>  <p>CASE 237021A1 223.0x71.0x4.9 36T</p>	<p>YEM-H7135</p>  <p>CASE 237023A1 230.0x152.5x9.0 32T</p>	<p>YEM-H7136</p>  <p>CASE 308029A1 230.0x151.0x9.0 64T</p>
<p>YEM-H7137</p>  <p>CASE 308030A1 230.0x152.5x5.0 64T</p>	<p>YEM-H7138</p>  <p>CASE 3125322R2 125.5x93.2x2.1 45T</p>	<p>YEM-H7139</p>  <p>CASE A188412 300.7x49.9x6.3 14T</p>	<p>YEM-H7140</p>  <p>DS0040 190.8x147.3x3.0 59T</p>	<p>YEM-H7141</p>  <p>CASE D50081</p>
<p>YEM-H7142</p>  <p>CASE D50084</p>	<p>YEM-H7143</p>  <p>CASE K963646 224.0x70.1x4.9 23T</p>	<p>YEM-H7144</p>  <p>CAT 1A3987 365.8x273.1x2.3 88T</p>	<p>YEM-H7145</p>  <p>CAT 2G0478 189.0x124.0x1.5 44T</p>	<p>YEM-H7146</p>  <p>CAT 2H6936 289.1x194.1x2.3 8T</p>

摩擦片 FRICTION PLATE

<p>YEM-H7147</p>  <p>CAT 3P0337 215.9X155.7X2.9 24T</p>	<p>YEM-H7148</p>  <p>CAT 3P0801 224.8X177.8X4.8 32T</p>	<p>YEM-H7149</p>  <p>CAT 3P3241 369.8X222.3X6.4 72T</p>	<p>YEM-H7150</p>  <p>CAT 3P5955 311.2X252.5X5.0 101T</p>	<p>YEM-H7151</p>  <p>CAT 3P8393 306.3X213.4X6.4 5T</p>
<p>YEM-H7152</p>  <p>CAT 3S7981 264.9X201.8X4.6 81T</p>	<p>YEM-H7153</p>  <p>CAT 3T1407 282.0X172.0X5.0 48T</p>	<p>YEM-H7154</p>  <p>CAT 3T9960 184.7X125.7X4.9 35T</p>	<p>YEM-H7155</p>  <p>CAT 4S5891 268.2X199.6X2.8 64T</p>	<p>YEM-H7156</p>  <p>CAT 4S9072 355.6X200.2X7.1 64T</p>
<p>YEM-H7157</p>  <p>CAT 5H0047 400.1X241.3X6.4 78T</p>	<p>YEM-H7158</p>  <p>CAT 5K8617 304.8X212.9X3.8 95T</p>	<p>YEM-H7159</p>  <p>CAT 5M1199 384.6X291.3X4.7 120T</p>	<p>YEM-H7160</p>  <p>CAT 5M6122 381.0X300.0X5.6 96T</p>	<p>YEM-H7161</p>  <p>CAT 5S7830 533.4X435.1X5.6 138T</p>
<p>YEM-H7162</p>  <p>CAT 5V0593 304.8X212.9X4.3 95T</p>	<p>YEM-H7163</p>  <p>CAT 6D2348 381.0X197.6X5.5 64T</p>	<p>YEM-H7164</p>  <p>CAT 6I8916 412.2X292.1X4.8 128T</p>	<p>YEM-H7165</p>  <p>CAT 6T8533 137.4X90.9X2.0 27T</p>	<p>YEM-H7166</p>  <p>CAT 6T8886 4393.7X273.8X2.4 8T</p>
<p>YEM-H7167</p>  <p>CAT 6T9194 139.2X98.6X1.8 54T</p>	<p>YEM-H7168</p>  <p>CAT 6Y2027 311.2X253.0X5.1 101T</p>	<p>YEM-H7169</p>  <p>CAT 6Y2084 402.0X82.9X9.1 18T</p>	<p>YEM-H7170</p>  <p>CAT 6Y2089 422.0X88.0X9.1 18T</p>	<p>YEM-H7171</p>  <p>CAT 6Y5352 281.7X220.0X4.9 61T</p>

摩擦片 FRICTION PLATE

<p>YEM-H7172</p>  <p>CAT 6Y5911 344.9X98.6X3.0 75T</p>	<p>YEM-H7173</p>  <p>CAT 6Y5912 240.0X172.7X5.1 48T</p>	<p>YEM-H7174</p>  <p>CAT 6Y5913 333.5X70.0X8.3 18T</p>	<p>YEM-H7175</p>  <p>CAT 6Y5914 215.0X168.4X2.9 54T</p>	<p>YEM-H7176</p>  <p>CAT 6Y5916 381.0X300.0X5.6 96T</p>
<p>YEM-H7177</p>  <p>CAT 6Y7915 255.5X168.4X2.8 54T</p>	<p>YEM-H7178</p>  <p>CAT 6Y7916 306.6X198.4X3.5 64T</p>	<p>YEM-H7179</p>  <p>CAT 6Y7922 160.0X108.0X4.0 52T</p>	<p>YEM-H7180</p>  <p>CAT 6Y7929 133.1X92.7X2.1 45T</p>	<p>YEM-H7181</p>  <p>CAT 6Y7953 178.0X116.4X2.7 74T</p>
<p>YEM-H7182</p>  <p>CAT 6Y7955 192.9X124.1X2.9 40T</p>	<p>YEM-H7183</p>  <p>CAT 6Y7981 224.8X165.1X4.3 32T</p>	<p>YEM-H7184</p>  <p>CAT 6Y8512 170.0X117.5X3.0 36T</p>	<p>YEM-H7185</p>  <p>CAT 7G0437 336.0X233.4X3.2 6T</p>	<p>YEM-H7186</p>  <p>CAT 7T3302 131.1X85.1X2.5 29T</p>
<p>YEM-H7187</p>  <p>CAT 7T3456 287.0X226.0X5.0 63T</p>	<p>YEM-H7188</p>  <p>CAT 8D8794 276.9X187.5X1.5 86T</p>	<p>YEM-H7189</p>  <p>CAT 8E2153 160.0X108.0X4.0 52T</p>	<p>YEM-H7190</p>  <p>CAT 8G4510 275.6X192.0X2.3 86T</p>	<p>YEM-H7191</p>  <p>CAT 8M5070 533.4X445.8X5.6 142T</p>
<p>YEM-H7192</p>  <p>CAT 8P2051 381.5X285.8X5.0 5T</p>	<p>YEM-H7193</p>  <p>CAT 9P7101 265.9X178.1X3.2 6T</p>	<p>YEM-H7194</p>  <p>CAT 9P9382 384.8X29.1X4.8 120T</p>	<p>YEM-H7195</p>  <p>CAT 101-5141 266.2X181.6X4.8 58T</p>	<p>YEM-H7196</p>  <p>CAT 101-5144 393.0X328.0X407 104T</p>

摩擦片 FRICTION PLATE

<p>YEM-H7197</p>  <p>CAT 108-5751 216.0X128.0X4.0 52T</p>	<p>YEM-H7198</p>  <p>CAT 110-7723 200.0X140.0X3.0 30T</p>	<p>YEM-H7199</p>  <p>CAT 122-1880 127.1X82.2X2.5 40T</p>	<p>YEM-H7200</p>  <p>CAT 122-1881 143.5X89.5X2.2 26T</p>	<p>YEM-H7201</p>  <p>CAT 159-0927 190.0X128.6X3.0 52T</p>
<p>YEM-H7202</p>  <p>CLARK 208772 165.1X74.2X4.0 19T</p>	<p>YEM-H7203</p>  <p>CLARK 232155 233.4X175.5X3.8 72T</p>	<p>YEM-H7204</p>  <p>CLARK 232394 218.9X158.8X2.7 14T</p>	<p>YEM-H7205</p>  <p>CLARK 232395 314.2X211.2X2.6 21T</p>	<p>YEM-H7206</p>  <p>CLARK 232635 257.3X190.5X2.7 16T</p>
<p>YEM-H7207</p>  <p>CLARK 232778 195.1X145.0X4.0 60T</p>	<p>YEM-H7208</p>  <p>CLARK 232779 233.4X175.5X3.8 72T</p>	<p>YEM-H7209</p>  <p>CLARK 243737 175.0X107.0X2.9 52T</p>	<p>YEM-H7210</p>  <p>CLARK 244133 129.0X76.0X1.5 4T</p>	<p>YEM-H7211</p>  <p>CLARK 887984 214.9X155.7X1.8 3T</p>
<p>YEM-H7212</p>  <p>CLARK 2106606 394.5X223.3X6.2 36T</p>	<p>YEM-H7213</p>  <p>CLARK 2115857</p>	<p>YEM-H7214</p>  <p>CLARK 2822116 117.9X68.1X2.2 33T</p>	<p>YEM-H7215</p>  <p>CLARK 4207444 148.3X92.7X2.3 45T</p>	<p>YEM-H7216</p>  <p>CLARK 4207455</p>
<p>YEM-H7217</p>  <p>CLARK 4210570</p>	<p>YEM-H7218</p>  <p>CLARK 4211394 154.0X99.0X2.7 60T</p>	<p>YEM-H7219</p>  <p>CLARK 4344394</p>	<p>YEM-H7220</p>  <p>GM30H RUBBER DISC</p>	<p>YEM-H7221</p>  <p>GM30H STEEL PLATE</p>

摩擦片 FRICTION PLATE

<p>YEM-H7222</p>  <p>GM35VL RUBBER DISC</p>	<p>YEM-H7223</p>  <p>GM35VL STEEL PLATE</p>	<p>YEM-H7224</p>  <p>M2X63 PAPER DISC</p>	<p>YEM-H7225</p>  <p>M2X63 STEEL PLATE</p>	<p>YEM-H7226</p>  <p>M2X96 PAPER DISC</p>
<p>YEM-H7227</p>  <p>M2X96 STEEL PLATE</p>	<p>YEM-H7228</p>  <p>M2X120 PAPER DISC</p>	<p>YEM-H7229</p>  <p>M2X120 STEEL PLATE</p>	<p>YEM-H7230</p>  <p>M2X146 PAPER DISC</p>	<p>YEM-H7231</p>  <p>M2X146 STEEL PLATE</p>
<p>YEM-H7232</p>  <p>M2X150-170 PAPER DISC</p>	<p>YEM-H7233</p>  <p>M2X150-170 STEEL PLATE</p>	<p>YEM-H7234</p>  <p>M2X210 PAPER DISC</p>	<p>YEM-H7235</p>  <p>M2X210 STEEL PLATE</p>	<p>YEM-H7236</p>  <p>M5X130 PAPER DISC</p>
<p>YEM-H7237</p>  <p>M5X130 STEEL PLATE</p>	<p>YEM-H7238</p>  <p>M5X180 PAPER DISC</p>	<p>YEM-H7239</p>  <p>M5X180 STEEL PLATE</p>	<p>YEM-H7240</p>  <p>MAG170 PAPER DISC</p>	<p>YEM-H7241</p>  <p>MAG170 STEEL PLATE</p>
<p>YEM-H7242</p>  <p>ML4002P PAPER DISC</p>	<p>YEM-H7243</p>  <p>ML4006P PAPER DISC</p>	<p>YEM-H7244</p>  <p>SG08 PAPER DISC</p>	<p>YEM-H7245</p>  <p>SG08 STEEL PLATE</p>	<p>YEM-H7246</p>  <p>SK2MX PAPER DISC</p>

摩擦片 FRICTION PLATE

<p>YEM-H7247</p>  <p>SK2MX STEEL PLATE</p>	<p>YEM-H7248</p>  <p>SK2MY PAPER DISC</p>	<p>YEM-H7249</p>  <p>SK2MY STEEL PLATE</p>	<p>YEM-H7250</p>  <p>FORKLIFT TRANSMISSION DISC BALKANCAR 6855.02.00.06 139.3X90.0X1.5 45T</p>	<p>YEM-H7251</p>  <p>BALKANCAR KTM1490 132.0X83.0X2.0 34T</p>
<p>YEM-H7252</p>  <p>CLARK 878373 133.1X92.7X1.6 45T</p>	<p>YEM-H7253</p>  <p>DAEWOO-DOOSAN A213070 122.0X60.0X3.0 24T</p>	<p>YEM-H7254</p>  <p>DAEWOO-DOOSAN A21307 128.9X80.0X2.3 50T1</p>	<p>YEM-H7255</p>  <p>DAEWOO-DOOSAN D141112 215.0X134.1X5.1 54T</p>	<p>YEM-H7256</p>  <p>DAEWOO-DOOSAN D141113 148.6X107.7X1.8 52T</p>
<p>YEM-H7257</p>  <p>DAEWOO-DOOSAN D700251 226.0X142.9X2.5 53T</p>	<p>YEM-H7258</p>  <p>KOMATSU 3EA-15-11180 137.8X80.0X3.2 4T</p>	<p>YEM-H7259</p>  <p>KOMATSU 3EC-15-31280 168.0X100.0X2.0 8T</p>	<p>YEM-H7260</p>  <p>KOMATSU 34B-15-11340 125.0X68.6X3.0 41T</p>	<p>YEM-H7261</p>  <p>KOMATSU 381-922539-1 181.6X85.6X1.7 85T</p>
<p>YEM-H7262</p>  <p>KOMATSU 381-922541-1 167.5X78.7X1.8 32T</p>	<p>YEM-H7263</p>  <p>KOMATSU 381-922549-1 181.4X112.8X1.7 85T</p>	<p>YEM-H7264</p>  <p>KOMATSU 381-922551-1 167.6X104.6X1.8 34T</p>	<p>YEM-H7265</p>  <p>TCM 134G-382121 132.0X80.0X1.6 24T</p>	<p>YEM-H7266</p>  <p>TCM 11243-82141 125.0X68.6X2.6 41T</p>
<p>YEM-H7267</p>  <p>TCM BK-703100-9000 133.6X77.0X2.8 38T</p>	<p>YEM-H7268</p>  <p>TCM BK-709500-5000 183.4X118.0X1.6 12T</p>	<p>YEM-H7269</p>  <p>TOYOTA 32412-22030-71 165.6X100.1X2.0 12T</p>	<p>YEM-H7270</p>  <p>TOYOTA 32432-22030-71 155.7X87.9X2.6 37T</p>	<p>YEM-H7271</p>  <p>YALE 505-971-559 133.1X92.7X2.1 45T</p>

摩擦片 FRICTION PLATE

<p>YEM-H7272</p>  <p>YALE 505-971-578 139.2X98.6X3.0 54T</p>	<p>YEM-H7273</p>  <p>INDIA TRACTOR BRAKE DISC ARJUN PAPER DISC</p>	<p>YEM-H7274</p>  <p>ARJUN STEEL PLATE</p>	<p>YEM-H7275</p>  <p>BALWAN CARBON DISC</p>	<p>YEM-H7276</p>  <p>EICHER PAPER DISC</p>
<p>YEM-H7277</p>  <p>EICHER STEEL PLATE</p>	<p>YEM-H7278</p>  <p>FARMTRAC PAPER DISC</p>	<p>YEM-H7279</p>  <p>JOHN DEERE 10</p>	<p>YEM-H7280</p>  <p>JOHN DEERE 12</p>	<p>YEM-H7281</p>  <p>M.F. PAPER DISC</p>
<p>YEM-H7282</p>  <p>M.F. STEEL PLATE</p>	<p>YEM-H7283</p>  <p>NEW HOLLAND CARBON DISC</p>	<p>YEM-H7284</p>  <p>NEW HOLLAND STEEL PLATE</p>	<p>YEM-H7285</p>  <p>SAME PAPER DISC</p>	<p>YEM-H7286</p>  <p>SWARAJ CARBON DISC</p>
<p>YEM-H7287</p>  <p>SWARAJ STEEL PLATE</p>	<p>YEM-H7288</p>  <p>JCB 331-16516 147.2X99.5X2.0 57T</p>	<p>YEM-H7289</p>  <p>JCB 331-16520 140.2X92.4X2.4 45T</p>	<p>YEM-H7290</p>  <p>JCB 445-03205 133.1X92.7X1.6 45T</p>	<p>YEM-H7291</p>  <p>JCB 445-12307 139.2X98.6X1.8 54T</p>
<p>YEM-H7292</p>  <p>JCB 450-10211 221.0X49.5X4.8 15T</p>	<p>YEM-H7293</p>  <p>JCB 450-10212 238.0X140.0X3.2 3T</p>	<p>YEM-H7294</p>  <p>JCB 451-01702 203.2X46.2X4.7 23T</p>	<p>YEM-H7295</p>  <p>JCB 451-22702 229.9X130.0X3.2 4T</p>	<p>YEM-H7296</p>  <p>JCB 458-20285 240.0X140.0X3.8 3T</p>

摩擦片 FRICTION PLATE

<p>YEM-H7297</p>  <p>JCB 458-20286 180.4X80.0X3.8 9T</p>	<p>YEM-H7298</p>  <p>JCB 458-20289 240.0X130.0X3.8 9T</p>	<p>YEM-H7299</p>  <p>JCB 458-20353 222.0X49.5X3.9 15T</p>	<p>YEM-H7300</p>  <p>KAWASAKI 52301-00540 158.0X95.2X2.7 38T</p>	<p>YEM-H7301</p>  <p>37212-20160 404.0X255.0X4.9 52T</p>
<p>YEM-H7302</p>  <p>37212-60150 164.3X107.0X2.0 64T</p>	<p>YEM-H7303</p>  <p>37212-60160 180.0X120.0X2.0 70T</p>	<p>YEM-H7304</p>  <p>37213-20170 400.0X150.0X7.0 32T</p>	<p>YEM-H7305</p>  <p>37213-20190 375.0X110.0X7.4 24T</p>	<p>YEM-H7306</p>  <p>37213-60160 131.0X79.2X2.6 30T</p>
<p>YEM-H7307</p>  <p>37213-60450 173.0X110.0X3.0 44T</p>	<p>YEM-H7308</p>  <p>52201-06390 191.9X124.1X3.3 40T</p>	<p>YEM-H7309</p>  <p>YK 1188 310 400 221.5X135.0X2.3 12T</p>	<p>YEM-H7310</p>  <p>YK 1188 310 510 209.0X130.3X3.3 54T</p>	<p>YEM-H7311</p>  <p>YK 1188 310 700</p>
<p>YEM-H7312</p>  <p>YK 1208 300 400 238.1X162.3X4.0 56T</p>	<p>YEM-H7313</p>  <p>YK 1208 310 200 247.0X179.0X2.3 12T</p>	<p>YEM-H7314</p>  <p>YS 584 020 262 295.0X225.0X2.7 6T</p>	<p>YEM-H7315</p>  <p>YS 584 990 840 270.0X212.0X3.9 68T</p>	<p>YEM-H7316</p>  <p>YS 1188 300 400 209.5X120.4X3.2 50T</p>
<p>YEM-H7317</p>  <p>KOMATSU 12F-10-11240</p>	<p>YEM-H7318</p>  <p>23S-15-12720 250.0X197.0X3.0 100T</p>	<p>YEM-H7319</p>  <p>23S-15-12730 280.0X221.0X5.0 75T</p>	<p>YEM-H7320</p>  <p>23S-15-12740 250.0X197.0X3.0 100T</p>	<p>YEM-H7321</p>  <p>104-22-33321 202.0X147X6.0 66T</p>

摩擦片 FRICTION PLATE

<p>YEM-H7322</p>  <p>110-22-11332</p>	<p>YEM-H7323</p>  <p>111-11-12120</p>	<p>YEM-H7324</p>  <p>113-15-22720 263.0X178.5X3.2 5T</p>	<p>YEM-H7325</p>  <p>113-15-22730 263.0X178.5X3.2 5T</p>	<p>YEM-H7326</p>  <p>124-15-52710</p>
<p>YEM-H7327</p>  <p>125-15-32750 252.0X179.0X3.2 5T</p>	<p>YEM-H7328</p>  <p>131-10-11110</p>	<p>YEM-H7329</p>  <p>131-10-11120 395.7X275.0X6.8 108T</p>	<p>YEM-H7330</p>  <p>131-10-61140 375.0X257X7.0 87T</p>	<p>YEM-H7331</p>  <p>131-21-43220 366.0X260.0X4.1 120T</p>
<p>YEM-H7332</p>  <p>150-21-23111 372X258X2.9</p>	<p>YEM-H7333</p>  <p>175-22-11140 390X276X4.7 128T</p>	<p>YEM-H7334</p>  <p>232-25-51430</p>	<p>YEM-H7335</p>  <p>235-25-11360 399.3X309.4X3.8 105T</p>	<p>YEM-H7336</p>  <p>281-15-12720 250.0X197.0X3.0 100T</p>
<p>YEM-H7337</p>  <p>418-33-11241 276.0X50.3X8.7 15T</p>	<p>YEM-H7338</p>  <p>418-33-21340 303.0X58.0X8.7 15T</p>	<p>YEM-H7339</p>  <p>419-15-12290 160.0X97.5X2.2 26T</p>	<p>YEM-H7340</p>  <p>419-33-11243 320.0X64.0X8.2 15T</p>	<p>YEM-H7341</p>  <p>419-33-11250 322.0X215.0X6.6 3T</p>
<p>YEM-H7342</p>  <p>714-07-12670 180.0X110.5X3.2 26T</p>	<p>YEM-H7343</p>  <p>714-07-29710 160.0X97.5X2.2 26T</p>	<p>YEM-H7344</p>  <p>TCM 16262-52601</p>	<p>YEM-H7345</p>  <p>TCM 16382-54221 138.6X90.5X1.6 35T</p>	<p>YEM-H7346</p>  <p>TCM 16382-54232 130.0X85X2.5</p>

摩擦片 FRICTION PLATE

脚踏阀 FOOT VALVE

<p>YEM-H7347</p>  <p>TCM 16382-54721 130.0X85.0X2.5 34T</p>	<p>YEM-H7348</p>  <p>TCM 16383-02171 280.0X87.5X6.2 23T</p>	<p>YEM-H7349</p>  <p>TCM 16422-52281 160.0X107.0X2.2 52T</p>	<p>YEM-H7350</p>  <p>TCM 16503-02332 370.1X126.2X7.2 35T</p>	<p>YEM-H7351</p>  <p>TCM 16603-02911 362.0X126.2X7.2 35T</p>	
<p>YEM-H7352</p>  <p>TCM 16783-02331 400.0X122.5X6.2 33T</p>	<p>YEM-H7353</p>  <p>TCM 18223-02452 280.0X87.5X6.2 23T</p>	<p>YEM-H7354</p>  <p>Z.F.0501 208 457 277.0X167.0X4.5 34T</p>	<p>YEM-H7355</p>  <p>Z.F.0750 140 028 179.0X103.0X3.5 35T</p>	<p>YEM-H7356</p>  <p>Z.F.4143-251-002 187.0X132.0X3.0 45T</p>	
<p>YEM-H7357</p>  <p>Z.F.4462 305 075 191.0X130.0X3.0 67T</p>	<p>YEM-H7358</p>  <p>Z.F.4472 209 002 232.7X142.0X4.0 48T</p>	<p>YEM-H7359</p>  <p>Z.F.4472 320 103 243.6X152.1X2.5 81T</p>	<p>YEM-H7360</p>  <p>Z.F.4474 304 049 293.0X185.0X4.0 88T</p>	<p>YEM-H7361</p>  <p>Z.F.4474 352 052 372.5X262.5X4.0 20T</p>	
<p>YEM-H7362</p>  <p>Z.F.4642 308 330 131.1X85.1X1.5 29T</p>	<p>YEM-H7363</p>  <p>Z.F.4644 208 013 170.9X102.9X2.0 35T</p>	<p>YEM-H7364</p>  <p>Z.F. 0501 208 884 196.0X142.0X2.0 64T</p>	<p>YEM-H7365</p>  <p>Z.F. 0501 309 330 177.5X109X2.0 35T</p>	<p>YEM-H7366</p>  <p>Z.F. 0750 140 009 137.4X98.9X2.0 27T</p>	
<p>YEM-H7367</p>  <p>Z.F. 4474 252 008 345.0X252.1X4.7 64T</p>	<p>YEM-H7368</p>  <p>VOLVO 795322-7 142.5X99.1X1.6 8T</p>	<p>YEM-H7369</p>  <p>VOLVO 4720768-3 155.0X92.7X9.0 45T</p>	<p>YEM-H7370</p>  <p>VOLVO 4720856-6 202.0X133.3X2.7 48T</p>	<p>YEM-H7371</p>  <p>VOLVO 4871796</p>	<p>YEM-H7372</p>  <p>VOLVO 4871966</p>
<p>YEM-H7373</p>  <p>VOLVO 4873042</p>	<p>YEM-H7374</p>  <p>VOLVO 11037030-1 224.0X70.1X4.8 23T</p>	<p>YEM-H7375</p>  <p>VOLVO 11037196</p>	<p>YEM-H7376</p>  <p>VOLVO 11102319 419.0X100.0X9.5 36T</p>	<p>YEM-H7377</p>  <p>VOLVO 11102321 360.0X100.0X9.5 36T</p>	<p>YEM-H7378</p>  <p>VOLVO 11103170</p>

<p>YEM-H7379</p>  <p>PC200-7/8(8孔)</p>	<p>YEM-H7380</p>  <p>PC60-7(6孔)</p>	<p>YEM-H7381</p>  <p>PC200-6 (7孔)</p>
<p>YEM-H7382</p>  <p>ZAX200脚踏阀总成 ZAX200 FOOTWOCK ASS'Y</p>	<p>YEM-H7383</p>  <p>ZAX200 ZAX330</p>	<p>YEM-H7384</p>  <p>日立200-5脚踏伐</p>
<p>YEM-H7385</p>  <p>神钢200-6E脚踏阀总成(8孔) FOOTWOCK ASS'Y</p>	<p>YEM-H7386</p>  <p>神钢200-8脚踏阀总成 SK200-8/SK350-8 YN30V00105F2 YN30V00105F3 FOOTWOCK ASS'Y</p>	<p>YEM-H7387</p>  <p>Sk75脚踏阀</p>
<p>YEM-H7388</p>  <p>卡特脚踏阀总成 E320C/E320D FOOTWOCK ASS'Y</p>	<p>YEM-H7389</p>  <p>E320D 八孔</p>	<p>YEM-H7390</p>  <p>E320/E312</p>

脚踏阀 FOOT VALVE

脚踏阀 FOOT VALVE

YEM-H7391



DH220-5/7
R220-5/7

YEM-H7392



通用型脚踏阀总成 (双边)
DH/R
FOOTWOOK ASS'Y

YEM-H7393



力士乐脚踏阀不带踏板

YEM-H7394



力士乐脚踏阀单边

YEM-H7395



力士乐脚踏阀总成
REXROTH
FOOTWOOK ASS'Y

YEM-H7396



三一脚踏阀总成(8孔)
SANY
FOOTWOOK ASS'Y

YEM-H7397



三一中联

YEM-H7398



川崎脚踏阀总成
FOOTWOOK ASS'Y

YEM-H7399



川崎脚踏阀 6孔

YEM-H7400



DX80

YEM-H7401



Dx260脚踏阀

YEM-H7402



通用型

YEM-H7403



通用型脚踏阀总成 (单边)
FOOTWOOK ASS'Y

YEM-H7404



炮机

YEM-H7405



小挖脚踏阀总成
FOOTWOOK ASS'Y

YEM-H7406



现代轮挖

YEM-H7407



现代轮挖

YEM-H7408



钻机

YEM-H7409



SH120/E200B

YEM-H7410



脚踏阀压板

YEM-H7411



破碎锤脚踏阀总成
FOOTWOOK ASS'Y

YEM-H7412



PC-6脚踏阀块总成

YEM-H7413



ZAX直喷

YEM-H7414



力士乐脚踏胶

YEM-H7415



卡特320CD脚踏胶

YEM-H7416



SK-8脚踏胶

YEM-H7417



通用脚踏胶

YEM-H7418



ZAX电喷脚踏胶

YEM-H7419



ZAX直喷脚踏胶

YEM-H7420



HD820长 脚踏胶

YEM-H7421



HD820短 脚踏胶

YEM-H7422



HD700长 脚踏胶

操纵杆总成 LEVER VALVE ASSY

操纵杆总成 LEVER VALVE ASSY

YEM-H7423



力士乐操纵杆总成
REXROTH
PILOT VALVE

YEM-H7424



力士乐操纵杆总成
REXROTH
OPERATING ROD ASS'Y

YEM-H7425



小松操纵杆总成
PC200-5/6/7 PC100/120-6
702-16-01180/702-16-01022/03530
PILOT VALVE

YEM-H7435



DX260手柄总成

YEM-H7436



卡特320C操纵杆总成
E320C
2970589/1772805
2063305/1659569
OPERATING ROD ASS'Y

YEM-H7437



川崎操纵杆总成 (7油孔)
SK135-8
XE150-8
OPERATING ROD ASS'Y

YEM-H7426



日立操纵杆总成 ZAX电喷
9239583/9268375
9247135/9257577
PILOT VALVE

YEM-H7427



卡特320D操纵杆总成
E320D/E330D/E336D
2970589
PILOT VALVE

YEM-H7428



神钢200-8操纵杆总成
SK200/210-8
SK350/460-8
YN30V00111F1
PILOT VALVE

YEM-H7438



DH/R220-5操纵杆 单键

YEM-H7439



DH/R225-7操纵杆 双键

YEM-H7440



DH225-9操纵杆 3键

YEM-H7429



神钢200-6操纵杆总成
SK200-6/6E
SK330-6E/SK480-6E
YT30V00008F2
PILOT VALVA

YEM-H7430



EC210操纵杆

YEM-H7431



卡特320B/C操纵杆

YEM-H7441



通用型操纵杆总成(韩国版)
DH/R
2420-9517
31N6-20200/25200/26200
OPERATING ROD ASS'Y

YEM-H7442



大字-7操纵杆总成(双按钮)
DH225-7
DH300-7
4200-0342A
OPERATING ROD ASS'Y

YEM-H7443



大字-9操纵杆总成 (3按键)
DH215-9
DH225-9
OPERATING ROD ASS'Y

YEM-H7444



R225-9手柄总成

YEM-H7432



三一75手柄总成

YEM-H7433



ZAX200子弹头座
ZAX直喷
9233096
PUSHER HEAD

YEM-H7434



川崎操纵杆总成 (7油孔)
SK135-8
XE150-8
PILOT VALVE

YEM-H7445



推土机操纵杆
OPERATING ROD ASS'Y

YEM-H7446



久保田161

YEM-H7447



日立200-3-5手柄总成

YEM-H7448





















VOLVO55/66/80

操纵杆总成 LEVER VALVE ASSY



















操纵杆系列 OPERATING ROD ASS'Y

<p>YEM-H7449</p>  <p>361-6015操纵杆</p>	<p>YEM-H7450</p>  <p>487-8455操纵杆</p>	<p>YEM-H7451</p>  <p>PC-8小松新款操纵杆</p>	<p>YEM-H7452</p>  <p>沃尔沃210操纵杆</p>
<p>YEM-H7453</p>  <p>川崎操纵杆</p>	<p>YEM-H7454</p>  <p>Ex操纵手柄 Manipulation Handle</p>	<p>YEM-H7455</p>  <p>SH 操纵手柄 Manipulation Handle</p>	<p>YEM-H7456</p>  <p>EX200-1 SK 操纵手柄 Manipulation Handle</p>
<p>YEM-H7457</p>  <p>DH 操纵手柄 Manipulation Handle</p>	<p>YEM-H7458</p>  <p>PC200-6 操纵手柄 Manipulation Handle</p>	<p>YEM-H7459</p>  <p>CAT 操纵手柄胶 Manipulation Handle</p>	<p>YEM-H7460</p>  <p>DH-7操纵手柄 胶</p>
<p>YEM-H7461</p>  <p>DH-9操纵手柄胶</p>	<p>YEM-H7462</p>  <p>PC200-5 操纵手柄 Manipulation Handle</p>	<p>YEM-H7463</p>  <p>DH-5黑色</p>	<p>YEM-H7464</p>  <p>加藤</p>

<p>YEM-H7465</p>  <p>R-9新款 (4按键)</p>	<p>YEM-H7466</p>  <p>VOLVO</p>	<p>YEM-H7467</p>  <p>ZAX电喷</p>
<p>YEM-H7468</p>  <p>力士乐 (单按钮)</p>	<p>YEM-H7469</p>  <p>力士乐 (三按钮)</p>	<p>YEM-H7470</p>  <p>力士乐 (双按钮)</p>
<p>YEM-H7471</p>  <p>力士乐 (四按钮)</p>	<p>YEM-H7472</p>  <p>SK行走手柄胶</p>	<p>YEM-H7473</p>  <p>SH行走手柄胶</p>
<p>YEM-H7474</p>  <p>CAT行走手柄胶</p>	<p>YEM-H7475</p>  <p>SH行走手柄胶</p>	<p>YEM-H7476</p>  <p>PC-6行走手柄胶</p>
<p>YEM-H7477</p>  <p>PC-5行走手柄胶</p>	<p>YEM-H7478</p>  <p>大字行走手柄胶</p>	<p>YEM-H7479</p>  <p>加藤行走手柄胶</p>
<p>YEM-H7480</p>  <p>三一行走手柄胶</p>	<p>YEM-H7481</p>  <p>PC200-5 dustproof cover</p>	<p>YEM-H7482</p>  <p>6D102防尘套 dustproof cover</p>

操纵杆系列 OPERATING ROD ASS'Y

操纵杆子弹头 JOYSTICK PUSHER

<p>YEM-H7483</p>  <p>PC200-7防尘套 dustproof cover</p>	<p>YEM-H7484</p>  <p>EX200 dustproof cover</p>	<p>YEM-H7485</p>  <p>E200B防尘套 dustproof cover</p>	<p>YEM-H7486</p>  <p>E320防尘套 dustproof cover</p>
<p>YEM-H7487</p>  <p>E320B防尘套 dustproof cover</p>	<p>YEM-H7488</p>  <p>6D31防尘套 dustproof cover</p>	<p>YEM-H7489</p>  <p>DH-7/9防尘套 dustproof cover</p>	<p>YEM-H7490</p>  <p>力士乐防尘套 dustproof cover</p>
<p>YEM-H7491</p>  <p>神钢防尘套 dustproof cover</p>	<p>YEM-H7492</p>  <p>Hd700防尘套 dustproof cover</p>	<p>YEM-H7493</p>  <p>Hd700长防尘套 dustproof cover</p>	<p>YEM-H7494</p>  <p>沃尔沃防尘套 dustproof cover</p>
<p>YEM-H7495</p>  <p>DH220-5防尘套 dustproof cover</p>	<p>YEM-H7496</p>  <p>ZAX200电喷行走推杆</p>	<p>YEM-H7497</p>  <p>ZAX200直喷行走推杆</p>	
<p>YEM-H7498</p>  <p>大宇/三一/小松通用型行走推杆</p>	<p>YEM-H7499</p>  <p>卡特B/C/D行走推杆</p>	<p>YEM-H7500</p>  <p>SK-8行走推杆</p>	

<p>YEM-H7501</p>  <p>EX200-2、3、5 Right 11.5</p>	<p>YEM-H7502</p>  <p>EX-5带珠专用</p>	<p>YEM-H7503</p>  <p>日立EX200-1 old</p>	<p>YEM-H7504</p>  <p>ZAX200 Long</p>
<p>YEM-H7505</p>  <p>ZAX200 short</p>	<p>YEM-H7506</p>  <p>ZAX电喷 Long</p>	<p>YEM-H7507</p>  <p>ZAX电喷 short</p>	<p>YEM-H7508</p>  <p>KATO</p>
<p>YEM-H7509</p>  <p>石川岛</p>	<p>YEM-H7510</p>  <p>玉柴35</p>	<p>YEM-H7511</p>  <p>玉柴60</p>	<p>YEM-H7512</p>  <p>小松PC200-3/5</p>
<p>YEM-H7513</p>  <p>小松PC200-6/7</p>	<p>YEM-H7514</p>  <p>三一75子弹头</p>	<p>YEM-H7515</p>  <p>KATO HD800 900</p>	<p>YEM-H7516</p>  <p>炮机</p>

操纵杆子弹头 JOYSTICK PUSHER

行走子弹头 WALKING PUSHER

<p>YEM-H7517</p>  <p>S6K 卡特10mm</p>	<p>YEM-H7518</p>  <p>E320 卡特15mm</p>	<p>YEM-H7519</p>  <p>E320C 卡特25mm</p>	<p>YEM-H7520</p>  <p>卡特307 φ12</p>
<p>YEM-H7521</p>  <p>大宇DH220-5 φ12</p>	<p>YEM-H7522</p>  <p>DH φ10</p>	<p>YEM-H7523</p>  <p>大宇DH225-7</p>	<p>YEM-H7524</p>  <p>住友SH</p>
<p>YEM-H7525</p>  <p>住友SH120 φ12</p>	<p>YEM-H7526</p>  <p>SK</p>	<p>YEM-H7527</p>  <p>R60-7</p>	<p>YEM-H7528</p>  <p>R225-7</p>
<p>YEM-H7529</p>  <p>R200-5</p>	<p>YEM-H7530</p>  <p>EX200-1 Left 9.8</p>	<p>YEM-H7531</p>  <p>EX200-1 Right 11.5</p>	<p>YEM-H7532</p>  <p>EX200-2、3、5 Left 9.8</p>

<p>YEM-H7533</p>  <p>E200B</p>	<p>YEM-H7534</p>  <p>E320 SH</p>	<p>YEM-H7535</p>  <p>E320B/C</p>	<p>YEM-H7536</p>  <p>杰西博</p>	
<p>YEM-H7537</p>  <p>SK200-5</p>	<p>YEM-H7538</p>  <p>SK230-6E</p>	<p>YEM-H7539</p>  <p>SK-8</p>	<p>YEM-H7540</p>  <p>小松</p>	<p>YEM-H7541</p>  <p>小松 PC-6</p>
<p>YEM-H7542</p>  <p>DH80 铲斗</p>	<p>YEM-H7543</p>  <p>DH220-5</p>	<p>YEM-H7544</p>  <p>福田</p>	<p>YEM-H7545</p>  <p>EX-1</p>	<p>YEM-H7546</p>  <p>EX-2/3</p>
<p>YEM-H7547</p>  <p>ZAX200</p>	<p>YEM-H7548</p>  <p>ZAX120-5、ZAX55</p>	<p>YEM-H7549</p>  <p>SH75X-3</p>	<p>YEM-H7550</p>  <p>玉柴</p>	<p>YEM-H7551</p>  <p>DX60</p>
<p>YEM-H7552</p>  <p>小螺牙DH130</p>	<p>YEM-H7553</p>  <p>大螺牙DH280</p>	<p>YEM-H7554</p>  <p>力勃海尔</p>	<p>YEM-H7555</p>  <p>炮机</p>	<p>YEM-H7556</p>  <p>山河智能45-55</p>

古田破碎锤 破碎锤结构图解及原理功能
古田の粉碎する器

YEM-H7557

- 1. 阀门系统 (Valve)**
设计标准、独特
适当调节压力，精确控制流量
确保破碎锤的最佳工作状态
- 2. 蓄能器 (Accumulator)**
用以补偿液压回路中的压力及防止震动
减缓冲击系统，延长装备使用寿命
保护挖掘的液压系统
补充油量，提高作业效率
- 3. 油缸 (Cylinder)**
高强度特殊钢材制成，经过深
度的热处理加工以最小油压系
统完成高低压循环作业
精密的加工设备，保障高品质
的产品
- 4. 贯体螺栓 (Through Bolt)**
连接破碎锤前体、缸体和后体
采用高强度材料特制
特殊热处理制作
防止机器本身意外断裂
四个一样的高强度螺栓设计



- 6. 钢钎 (Chisel)**
采用优质特殊钢材，坚韧、耐磨、不易断裂
可选用不同的类型中：
1、角锥形2、楔子形3、圆锥形4、钝形
- 8. 活塞 (Piston)**
采用特殊钢材及深度热处理
高标准设计，确保精度和同心度
加大打击力和减少反冲击力
精密的加工设备，确保高品质的产品
- 7. 氮气室 (Back Head)**
内充有氮气，储蓄动力
减少油路中不规则的液压力
减少对加载机和操作者的反冲击力
担当高打击破碎效率

源自精良的设备

Model型号	GL53	GL60	GL68	GL75
(ton)Weight重量	90	157	242	380
(mm)Length长度	1046	1220	1347	1520
(mm)Width宽度	180	185	235	240
(l/min)Required Flow要求流量	20-35	25-50	30-45	40-80
(bar)Operating Pressure工作压力	80-110	90-120	130-150	130-150
(bpm)Hitting Frequency击打频率	650-1100	550-1100	450-750	400-800
(joule)Impacting Capacity冲击能量	420	600	810	1070
(inch)Size Of Oil Tube油管尺寸	1/2"	1/2"	1/2"	1/2"
(mm)Drill Shank(Diameter/Length)钎体(直径、长度)	53	60	68/697	75/800
(ton)Suitable grab适合挖机	0.8-0.3	1.5-4.0	4.0-6.0	6.0-9.0

Model型号	GL85	GL100	GL135
(ton)Weight重量	510	788	1535
(mm)Length长度	1737	1990	2295
(mm)Width宽度	395	450	466
(l/min)Required Flow要求流量	80-110	80-110	120-150
(bar)Operating Pressure工作压力	130-150	150-170	160-180
(bpm)Hitting Frequency击打频率	400-800	450-625	400-490
(joule)Impacting Capacity冲击能量	1300	2500	4300
(inch)Size Of Oil Tube油管尺寸	3/4"	3/4"	1"
(mm)Drill Shank(Diameter/Length)钎体(直径、长度)	85/810	100/1055	135/1200
(ton)Suitable grab适合挖机	8.0-10.0	10.0-16.0	18.0-23.0

Model型号	GL140	GL150
(ton)Weight重量	1635	2248
(mm)Length长度	2295	2601
(mm)Width宽度	247	600
(l/min)Required Flow要求流量	120-150	170-240
(bar)Operating Pressure工作压力	160-180	165-185
(bpm)Hitting Frequency击打频率	400-490	310-490
(joule)Impacting Capacity冲击能量	4300	7500
(inch)Size Of Oil Tube油管尺寸	1"	1-1/4"
(mm)Drill Shank(Diameter/Length)钎体(直径、长度)	140/1250	150/1400
(ton)Suitable grab适合挖机	18.0-26.0	26.0-33.0



古田破碎锤 源自精良的设备
古田の粉碎する器

Model型号	GL53	GL60	GL68	GL75
(ton)Weight重量	90	157	242	380
(mm)Length长度	1046	1220	1347	1520
(mm)Width宽度	180	185	235	240
(l/min)Required Flow要求流量	20-35	25-50	30-45	40-80
(bar)Operating Pressure工作压力	80-110	90-120	130-150	130-150
(bpm)Hitting Frequency击打频率	650-1100	550-1100	450-750	400-800
(joule)Impacting Capacity冲击能量	420	600	810	1070
(inch)Size Of Oil Tube油管尺寸	1/2"	1/2"	1/2"	1/2"
(mm)Drill Shank(Diameter/Length)钎体(直径、长度)	53	60	68/697	75/800
(ton)Suitable grab适合挖机	0.8-0.3	1.5-4.0	4.0-6.0	6.0-9.0

Model型号	GL85	GL100	GL135
(ton)Weight重量	510	788	1535
(mm)Length长度	1737	1990	2295
(mm)Width宽度	395	450	466
(l/min)Required Flow要求流量	80-110	80-110	120-150
(bar)Operating Pressure工作压力	130-150	150-170	160-180
(bpm)Hitting Frequency击打频率	400-800	450-625	400-490
(joule)Impacting Capacity冲击能量	1300	2500	4300
(inch)Size Of Oil Tube油管尺寸	3/4"	3/4"	1"
(mm)Drill Shank(Diameter/Length)钎体(直径、长度)	85/810	100/1055	135/1200
(ton)Suitable grab适合挖机	8.0-10.0	10.0-16.0	18.0-23.0

Model型号	GL140	GL150
(ton)Weight重量	1596	2155
(mm)Length长度	2350	2695
(mm)Width宽度	580	750
(l/min)Required Flow要求流量	120-150	170-240
(bar)Operating Pressure工作压力	160-185	165-185
(bpm)Hitting Frequency击打频率	400-490	310-490
(joule)Impacting Capacity冲击能量	4300	7500
(inch)Size Of Oil Tube油管尺寸	1"	1-1/4"
(mm)Drill Shank(Diameter/Length)钎体(直径、长度)	140/1250	150/1400
(ton)Suitable grab适合挖机	18.0-26.0	26.0-33.0

古田破碎锤 GL BREAKER



古田破碎锤 GL BREAKER

古田破碎锤 源自精良的设备
古田の粉碎する器

Item		Model	GL150		GL140		GL135		GL100	
Carrier Weight	ton		40~55		30~45		32~44		28~35	
	lbs		88,200~121,000		66,120~99,180		70,400~96,800		61,700~79,400	
Operating	OpenType(H)	kg/pound	3207	7055	2650	5830	2650	5830	2413	5320
Weight	SilenceType(S)	kg/lbs	3550	7810	3055	6757	2800	6757	2555	5633
		Joule	9340		7308		7719		6610	
Impact Energy		Ft.Lbs	6227		4872		5146		4407	
		bar	170	190	170	190	170	190	160	180
OperatingPressure		psi	2418	2702	2418	2702	2418	2702	2276	2560
		Oil Flow	1/min	210	290	180	250	180	250	180
No.ofStrike		bpm	200	350	250	400	250	400	300	450
Hose Size		mm(inch)	31.75 {1+1/4}		31.75 {1+1/4}		31.75 {1+1/4}		31.75 {1+1/4}	
Tool Diameter		mm(inch)	175 {6.9}		165 {6.5}		160 {6.1}		155 {6.1}	
Noise Level (S-Type)	LPA	db(A)	96		95		91		93	
	LWA		125		124		119		121	

GL85		GL75		GL68		GL60		GL53	
25~35		18~26		18~25		12~18		11~16	
55,000~77,000		39,700~57,300		39,700~55,000		26,400~39,600		24,200~35,300	
2150	4730	1750	3847	1620	3564	1200	2640	790	1738
2300	5060	1754	3867	1700	3740	1310	2882	860	1892
6341		4500		4335		3341		2193	
4227		3000		2890		2227		1462	
160	180	160	180	160	180	150	170	150	170
2276	2560	2276	2560	2276	2560	2133	2418	2133	2418
160	200	120	180	130	150	90	120	80	110
300	450	350	500	350	600	350	750	350	700
31.75 {1+1/4}		25.4 {1}		25.4 {1}		25.4 {1}		19.1 {3/4}	
150 {5.9}		140 {5.5}		135 {5.3}		120 {4.7}		100 {3.9}	
93		90		91		90		89	
121		118		119		118		117	

金属剪 YEM-H7585

特殊耐磨-稳定的结构
易更换的专用齿
具提供剪切能力



Shear

Special abrasion-resistant
frame Easy control teeth
Upgrade cutting ability

液压拆除剪 YEM-H7586

超强剪切力
特殊的耐磨结构及齿具为各
种机械的功能变化提供可能
超大开口



Shear

More Powerful Special
abrasion-resistant
frame&Teeth Applicable to a
variety of carriers for small
works Wide jaw

可配套的机型

型号Model	GLB200CR	GLB300CR
重量Weight(kg)	1,950	2,770
长度Length(mm)	2,391	2,688
宽度Width(mm)	503	620
最大流量 Max Oil Flow rate(l/min)	150-250	200-300
工作压力 Operating Pressure(bar)	320	320
剪切力 Rotating Pressure(ton)	140	140
挖掘机Excavator(ton)	18-26	30-45

型号Model	GLB200CR	GLB300CR
重量Weight(kg)	1,880	2,760
长度Length(mm)	2,165	2,412
宽度Width(mm)	1,281	1,598
最大流量 Max Oil Flow rate(l/min)	200	250
工作压力 Operating Pressure(bar)	320	320
最大开口 Max Jaw Opening(mm)	900	1,100
剪切力 Rotating Pressure(ton)	111	157
回转角度 Rotating Angle(°)	360°	360°
挖掘机Excavator(ton)	18-26	30-45

Model型号	GL68	GL75	GL85	GL100	GL135	GL140	GL150
DOOSAN DAEWOO 斗山/斗山	DH50	DH55		S130	DH220	DH220	DH300
	DH55	DH60		DH130W	DH225	DH225	DH330
HYUNDAI 现代	RS-5			R130W	R200	R200	R260
	R60-5			HX60W	R210	R210	R290
	R60-7				R220	R220	R360
					R215	R215	R305
					R225	R225	R300
KOMATSU 小松	PC45	PC60	PC90		PC200	PC200	PC250
	PW60	PW60	PC100	PC100	PC220	PC220	PC300
	PC50			PC120	PW210	PC250	PC310
	EX35			EX100	EX200	EX200	
HITACHI 日立	EX55	EX60W	EX90	EX100WD	EX210	EX210	EX300
					EX220	EX220	
					ZX210	ZX200	
				ZX210	ZX210		
					ZX230		
CAT卡特				205	320	320	325
				307	322	325	330
KOBELCO 神钢	SK025	SK60	SK60	SK100	SK200	SK270	SK300
					SK200E	SK300	SK320
	SK030				SK230	SK230	SK-L330
				SK220	SK220		
VOLVO 沃尔沃	MXSE25				EC210	EC240	EC290
						EC210	
						EC290	
LIEBHERR 利勃海尔		A310	A310	IL310	A912	R92L1T	R922
				R312	A922	914	934
				A901	904	924	A932
						A912	
					A922		
SUMTOMO 住友	S25	S25	S25	S40	SH200	SH200	S280
	S140	S160	S250	S260	S260	S280	SFL300
				S265			S340
KATO加腾	HD180G	HD250	HD399	HD450	HD700	HD1023	HD1200
	HD250	HD400	HD400	HD500	HD800	HD1100	HD1250
					HD820		HD1430
詹阳	JY35				JY161	JY320	JY320
					JY200		
ATLAS 阿特拉斯					2006LC	2306LC	
					2106LC	2106LC	2606LC
					2006LC		3306LC
装载机	ZL15	ZL30	ZL40				
	ZL30	ZL40	ZL50	ZL50			

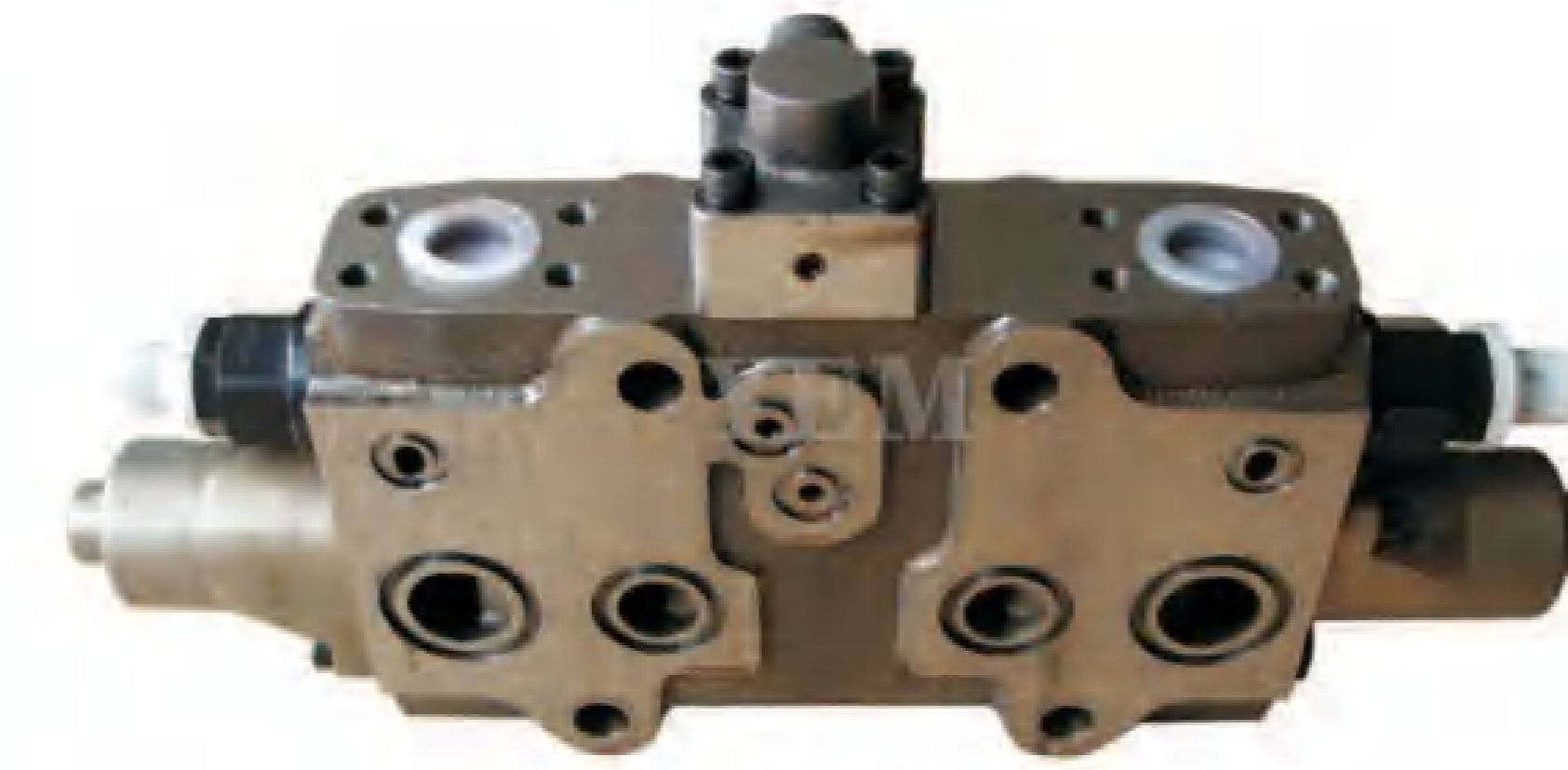

YEM-H7587
PC200-7 PC220-7 723-41-07600备用阀
Standby valve hydraulic hammer



YEM-H7588
PC200-6 PC220-6 723-41-05300备用阀
Standby valve hydraulic hammer



YEM-H7589
神钢备用阀
Standby valve hydraulic hammer



YEM-H7590
神钢备用阀
Standby valve hydraulic hammer



YEM-H7591
PC120-6(小机头)炮阀
Standby valve hydraulic hammer



YEM-H7592
PC-228US-3炮阀
Standby valve hydraulic hammer



YEM-H7593
PC120-6(大机头)炮阀
Standby valve hydraulic hammer



YEM-H7594
PC60-7备用阀
Standby valve hydraulic hammer



KRUPP			
品名	直径(mm)	长度(mm)	重量(kg)
GB45	42	470	6
GB50/55	45	560	7
GB60V	48	500	6
GB60/75	55	590	10
GB85/90V	62	600	11
GB100/110V	65	700	18
GB130/131/135/140	65	780	18
GB170/185/190V	75	800	25
GB200	80	835	29
GB220V	80	900	30
GB230V	80	800	28
GB300/301/305V	80	900	30
GB350V	90	900	40
GB400/401	80	800	27
GB550/560CS/V	100	1000	55
GB580	100	1000	55
GB600/601	100	1000	55
GB700/701/702/705	115	1150	86
GB710/720CS/V	115	1080	82
GB780	120	1100	87
GB780V	120	1100	89
GB800	135	1150	115
GB900/901/902	135	1150	115
GB950/960CS/V	135	1080	110
GB1000	140	1200	130
GB1000V	140	1200	128
GB1200	150	1250	155
GB1300/1500CD/V	150	1200	151
GB1800/2000CS/V	165	1400	220
GB2100	165	1300	220
GB2200/2500CS/V	180	1500	270

N.P.K			
品名	直径(mm)	长度(mm)	重量(kg)
H-08X	45	480	5
H-1XA	57	580	10
H-2XA	65	620	15
H-2X/3XA	75	720	22
H-4X	90	780	30
H-5X/6X	96	930	50
H-7X	105	930	57
H-8XA	115	1000	72
H-9X	115	1000	72
H-10X	126	1100	93
H-10XB/10XE	126	1100	93
H-11X/14X	140	1250	140
H-12X	135	1200	115
H-16X	145	1300	148
H-18X	146	1400	160
H-20X	156	1400	183
H-25X	165	1400	220
E-12X	126	1100	93
E-15X	136	1200	120
E-18X	146	1300	148
E-106	41	410	4
E-200	42	480	5
E-201	50	510	8
E-202	57	580	12
E-203	66	740	18
E-204	76	800	22
E-205	86	890	34
E-208	116	1160	74
E-210	126	1100	98
E-212	126	1100	98
E-213	136	1200	122
E-215	140	1200	130
E-216	146	1300	148
E-218	146	1300	148
E-220	156	1400	183
E-224	156	1450	188
E-225	165	1520	228
E-240	184	1740	320

MITSUBISHI			
品名	直径(mm)	长度(mm)	重量(kg)
MKB60M	38	400	
MKB100M	45	450	5
MKB120M	45	520	6
MKB150M	55	600	11
MKB300M	70	750	22
MKB500N	80	900	30
MKB900N	100	1000	55
MKB1200N	120	1150	90
MKB1500V	135	1150	115
MKB1800V	145	1200	140
MKB2100V	150	1280	160
MKB2500V	160	1350	200
MKB3000V	165	1500	230
MKB4000V	180	1600	278
MKB6000V	200	1450	
MKB7000V	220	1800	

MIRACLE			
品名	直径(mm)	长度(mm)	重量(kg)
MB15M	40	450	3
MB20M	45	500	4
MB35M	58	590	12
MB50M	70	700	20
MB80M	80	750	30
MB100M	85	850	35
MB130M	100	1050	55
MB160M	125	1180	100
MB300M	140	1250	130
MB180F	120	1100	95
MB250F	135	1200	115
MB260F	135	1250	120
MB350F	150	1300	150
MB450F	155	1450	186
MB600F	175	1500	260

OKADA			
品名	直径(mm)	长度(mm)	重量(kg)
OUB-301	50	500	6
OUB-302	61	550	9
OUB-303	68	700	12
OUB-304	74	700	19
OUB-305	85	900	32
OUB-308	110	1000	32
OUB-310	122	1100	32
OUB-312	130	1150	32
OUB-316	140	1250	32
OUB-318	150	1400	170
OUB-512	130	1050	100
UB-5	80	750	30
UB-8/UB7	98	1000	45
UB-11	122	1100	83
UB-14	136	1200	117
UB-17	138	1250	138
UB-23	158	1500	180

FURUKAWA			
品名	直径(mm)	长度(mm)	重量(kg)
HB100	55	500	9
HB200	70	510	13
HB700	104	940	49
HB1G	36	400	3
HB2G	45	460	4
HB3G	60	560	11
HB5G	70	650	20
HB8G	90	750	30
HB10G	105	1000	65
HB15G	120	1000	80
HB20G	135	1200	120
HB30G	150	1300	157
HB40G	160	1400	200
HB50G	180	1500	270
HB1200	140	1200	130
F3	52	520	8
F4	60	540	11
F5	68	610	16
F6	75	720	23
F9	90	800	32
F12	105	1000	66
F19	120	1100	86
F22/F20	135	1200	117
F27	140	1300	141
F35	150	1400	164
F45	165	1450	220

KWANGLIM			
品名	直径(mm)	长度(mm)	重量(kg)
SG200	45	500	5
SG300	57	600	10
SG350	68	700	17
SG400	75	690	20
SG600	90	800	35
SG800	100	1000	55
SG1200	120	1100	90
SG1800	135	1200	120
SG2100	138	1250	125
SG2500	145	1300	151
SG2800	155	1450	190
SG3200/3300	158	1500	200
Sg5000	180	1600	280

TOYO			
品名	直径(mm)	长度(mm)	重量(kg)
THBB71	45	480	5
THBB101	57	580	10
THBB301	70	740	19
THBB401	80	900	32
THBB801	100	930	49
THBB1400	136	1150	114
THBB1600	138	1200	127
THBB1401	130	1100	92
THBB2000	150	1280	155

SOOSAN			
品名	直径(mm)	长度(mm)	重量(kg)
SH200	70	600	17
SH400	95	840	40
SH700	105	930	57
SH18G	120	1000	80
SH20G	135	1200	114
SH30G	150	1300	162
SH35G	140	1300	141
SH40G	160	1400	200
SB-30	53	580	9
SB-35	60	630	13
SB-40	68	680	17
SB-43	75	750	22
SB-45	85	850	31
SB-50	100	1000	55
SB-60	125	1050	90
SB-70	135	1200	114
SB-81	140	1250	130
SB-100	150	1376	172
SB-121	155	1450	185
SB-131	165	1500	213
SB-151	175	1500	256

GENERAL BREAKER			
品名	直径(mm)	长度(mm)	重量(kg)
GBM60	40	450	3
GBM90	45	500	5
GBM1T	58	580	10
GBM2T	70	700	18
GBM3T	75	750	22
GBM4T	90	902	38
GBM5T	100	1050	55
GBM6T	125	1180	97
GBM8T	140	1250	132
GBM11T	155	1500	183
GBM14T	160	1500	182
GBM8AT	135	1250	125
GBM8F	137	1250	125
GBM170E	120	1110	83
GBM220E	135	1200	114
GBM290E	150	1300	163
GBM300E	150	1300	164
GBM400E	155	1500	200

TOKU			
品名	直径(mm)	长度(mm)	重量(kg)
TNB-1E	50	500	6
TNB-2E	58	590	10
TNB-4E	75	710	20
TNB-5E/6E	95	800	40
TNB-7E/8E/10E	115	930	63
TNB-13E	135	1150	110
TNB-14E/16E	135	1150	117
TNB-150	135	1200	121
TNB-22E	145	1200	136
TNB-1425	146	1300	140

MSB			
品名	直径(mm)	长度(mm)	重量(kg)
SAGA20	48	500	6
SAGA30	62	580	12
SAGA40	68	600	15
SAGA50	68	697	17
SAGA80	75	742	28
SAGA100	85	895	37
SAGA120	98	950	49
SAGA180	100	1100	90
SAGA200	135	1200	122
SAGA300	150	1300	150
SAGA350	153	1400	176
MS250	75	730	23
MS200	70	680	19
MS300	85	790	32
MS400	95	905	45
MS450	100	920	51
MS500	110	950	64
MS550	120	1050	84
MS600	130	1100	103
MS700	140	1200	131
MS750	160	1300	185
MS800	160	1300	185
MS900	170	1450	233

KLT			
品名	直径(mm)	长度(mm)	重量(kg)
BT150	53	580	8.6
BT200	68	690	17.5
BT350	75	750	22.5
BT500	85	810	35
BT600	100	1000	57
BT650	125	1100	95
BT810	135	1200	121
BT1000	140	1300	136
BT1100	140	1300	136
BT3000	150	1300	163
BT3600	155	1500	182

RWB			
品名	直径(mm)	长度(mm)	重量(kg)
RWB70	135	/	115
RWB80	140	/	126
RWB100	150	/	155
RWB121	155	/	182
RWB140	165	/	205
RWB155	180	/	/

DAEMO			
品名	直径(mm)	长度(mm)	重量(kg)
DMB03	70	600	15
DMB04	95	900	43
DMB06	105	930	57
DMBS150V	57	650	12
DMBS500V	70	730	20
DMBS900V	85	850	34
DMBS1300V	105	975	60
DMBS1800V	120	1165	93
DMBS2200-11	135	1250	127
DMBS2300V	135	1200	121
DMBS2500V	145	1280	149
DMBS3000V	150	1400	175
DMBS3600S	150	1400	175
DMBS5000V	165	1650	249

HANWOO			
品名	直径(mm)	长度(mm)	重量(kg)
RHB301	45	480	4
RHB303	50	490	8
RHB304	58	600	11
RHB305	68	450	21
RHB306	80	850	30
RHB309	85	900	35
RHB313	105	1050	62
RHB320	125	1150	100
RHB321	130	1200	113
RHB322/325/323	135	1200	120
RHB328/330/332	150	1450	181
RHB333	155	1450	186
RHB340	165	1450	219
RHB350	180	1600	285

BLT			
品名	直径(mm)	长度(mm)	重量(kg)
BLT20	53	580	10
BLT30	70	700	20
BLT40	75	750	23
BLT50	85	800	35
BLT60	100	950	50
BLT80-1	135	1200	115
BLT80-2	135	1250	120
BLT81	140	1300	135
BLT100	140	1300	135
BLT160	155	1400	180
BLT190	160	1500	200

RWB			
品名	直径(mm)	长度(mm)	重量(kg)
RWB30	53	/	10
RWB40	68	/	18
RWB43	75	/	23
RWB45	85	/	29
RWB50	100	/	54



YEM-H7601
破碎锤活塞杆 Piston



YEM-H7602
氮气瓶 Nitrogen Gas Bottle



YEM-H7603 下缸体 Forebody



YEM-H7604 换向阀

YEM-H7605 炮机阀 Valve

YEM-H7606 截止阀 Stopvaive



YEM-H7607 皮碗

YEM-H7608 脚踏阀 PEDAIVAIVE



YEM-H7609
破碎锤圆销 Pin

YEM-H7610
破碎锤扁销 Retainer Pin



YEM-H7611

炮尖螺丝 GB220E/HB20G 42*440



YEM-H7612

炮尖螺丝-短 HB10G 36*370



YEM-H7613

炮尖螺丝 HB20G/GE220 42*3*475



YEM-H7614

炮尖螺丝-短 SB81/81N/GB8AT 47*450



YEM-H7615

炮尖螺丝-短 HB30G 48*500



YEM-H7616

炮尖螺丝 SB50 36*320



YEM-H7617

炮尖螺丝 HB20G 42*4*980



YEM-H7618

炮尖螺丝(长) NPK10XB 45*1110



YEM-H7619

炮尖螺丝(长) TNB150



YEM-H7620

炮尖螺丝 GB8T 48*1050



YEM-H7621

炮尖螺丝长 SB50



YEM-H7622

炮尖螺丝(长) HB8G\F9 27*655



YEM-H7623 合资压管机 Pipe extruding machine



YEM-H7624 加强型压链机 Chain making tools



YEM-H7625
 套装液压表
 Hydraulic gauge set



YEM-H7626
 检测仪



YEM-H7627
 液压表接头
 Hydraulic



YEM-H7628
 油管接头
 Hydraulic hose fitting



YEM-H7629
 卡特快速接头
 Cat express fitting



液压油缸零件

YEM-H7630

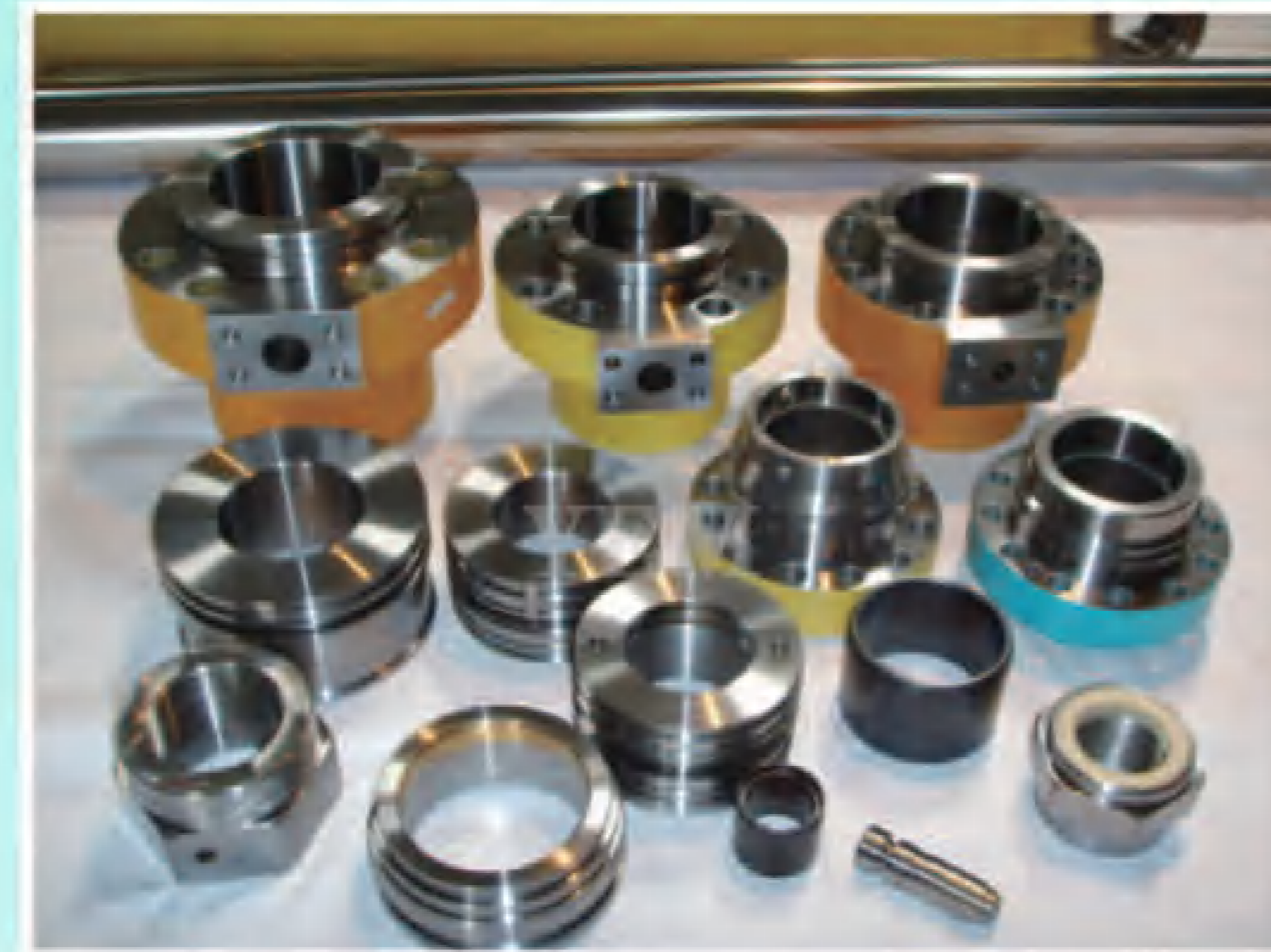

缸盖、活塞、螺母、前后缓冲

YEM-H7631



YEM-H7632



YEM-H7633 缸盖 Cylinder Head

液压油缸用珩磨无缝钢管（缸筒）

本公司銷售之缸筒均選用優質鋼材，經過專用機床加工而成，符合國家標準。該產品廣泛使用於各種工程機械、船舶、輕工業、冶金業、汽車製造業等。挖掘機缸筒選用高強合金鋼材(27SiMn)制造而成。

一、製造標準

- 1、內表面粗糙度 : Ra0.2-0.4
- 2、直線度(圓跳動) : 0.5-1/1000
- 3、內徑公差等級 : H8

二、壁厚與承壓

公式 $T=pd/200S$

T: 壁厚 單位: mm d: 內徑 單位: mm
 P: 耐壓力 單位: kg/cm² S: 安全係數 抗拉強度/5

三、化學成分及機械強度

國標牌號	日本鋼材牌號	化學成分 %					機械強度		延伸率 %	國標
		C	Si	Mn	P	S	抗拉強度 Mpa ^(5b)	屈服強度 Mpa ^(5a)		
20# (冷拔)	STKM13C	0.17-0.24	0.17-0.37	0.35-0.65	<0.035	<0.035	520	390	15	GB699-88
	13A	0.17-0.24	0.17-0.37	0.35-0.65	<0.035	<0.035	410	245	25	GB699-88
20# (熱軋)	STKM16A	0.42-0.50	0.17-0.37	0.50-0.80	<0.035	<0.035	590	370	16	GB699-88
	16A (調質)	0.42-0.50	0.17-0.37	0.50-0.80	<0.035	<0.035	680	438	15	GB699-88
27SiMn (熱軋)	27SiMn	0.24-0.32	1.10-1.40	1.10-1.40	<0.035	<0.035	693	438	13	GB3077-88
	27SiMn (熱軋、調質)	0.24-0.32	1.10-1.40	1.10-1.40	<0.035	<0.035	980	785	12	GB3077-88

四、內徑公差等級

單位: mm

等級 \ 直徑	φ10-φ18	φ19-φ30	φ31-φ50	φ51-φ80	φ81-φ120	φ121-φ180	φ181-φ250	φ251-φ315
H7	+0.018 0	+0.021 0	+0.025 0	+0.030 0	+0.035 0	+0.040 0	+0.046 0	+0.052 0
H8	+0.027 0	+0.033 0	+0.039 0	+0.046 0	+0.054 0	+0.063 0	+0.072 0	+0.081 0
H9	+0.043 0	+0.052 0	+0.062 0	+0.074 0	+0.087 0	+0.100 0	+0.115 0	+0.130 0



YEM-H7634
罗母 Jack Shaft Nut

YEM-H7635
杯士 Bushing

YEM-H7636
缓冲套

YEM-H7637
内缸盖 Collar



YEM-H7638 泵芯 Jack Shaft



YEM-H7639 活塞 Jack piston

液压油缸用镀铬活塞杆

本公司銷售之镀铬活塞杆選用優質碳素鋼或合金鋼材經過精密加工後鍍硬鉻而成。該產品廣泛使用於各種工程機械、船舶、輕工業、冶金業、汽車製造業等。挖掘機活塞杆選用合金鋼材(40Cr)經過調質或調質后表面高频加硬處理。

一、製造標準

- 1、表面粗糙度： Ra0.2以下
- 2、直線度：(圓跳動)：0.2/1000
- 3、表面尺寸公差： f8
- 4、鹽霧腐蝕測試(標準厚度)：連續40小時以上
- 5、鍍鉻層厚度： 0.03-0.04 mm (可按要求加厚)
- 6、鉻層硬度： Hv850-1000
- 7、電感硬化層厚度： 1.5-2.5mm
- 8、電感硬化層硬度： HRC 50-58
- 9、調質硬度(45#鋼) HB 220-250
調質硬度(40Cr鋼) HB 250-280

二、化學成分及機械強度

國標牌號	日本鋼材牌號	化學成分 %						機械強度		延伸率 %	標準
		C	Si	Mn	Cr	P	S	抗拉強度 Mpa ^(6b)	屈服強度 Mpa ^(6s)		
45# (熱軋)	S45C	0.42-	0.17-	0.50-	/	<0.035	<0.035	590	370	16	GB699-88
		0.50	0.37	0.80							
45# (熱軋、調質)	S45C 調質	0.42-	0.17-	0.50-	/	<0.035	<0.035	680	438	15	GB699-88
		0.50	0.37	0.80							
40Cr (熱軋)	Scr440	0.37-	0.20-	0.50-	0.80-	<0.035	<0.035	730	540	15	GB3077-88
		0.45	0.40	0.80	1.10						
40Cr (熱軋、調質)	Scr440 調質	0.37-	0.20-	0.50-	0.80-	<0.035	<0.035	980	785	13	GB3077-88
		0.45	0.40	0.80	1.10						

四、活塞杆公差等級

單位：mm

等級 \ 直徑	φ18-φ30	φ31-φ50	φ51-φ80	φ81-φ120	> φ120
f7	-0.020 -0.041	-0.025-0.050	-0.030 -0.060	-0.036 -0.071	-0.043 -0.083
f8	-0.020 -0.053	-0.025-0.064	-0.030 -0.076	-0.036 -0.090	-0.043-0.106
f9	-0.020 -0.072	-0.025-0.087	-0.030 -0.104	-0.036 -0.123	-0.043-0.143

YEM-H7640



本公司现货供应上列型号大齿圈

序号	型号	序号	型号	序号	型号	序号	型号
1	PC60-7	19	SH200AI	37	SK07-N2	55	现代305LC-7
2	PC60-7-76齿	20	SH200A3	38	日立EX60-5	56	现代300-5
3	PC60-6-80齿	21	SH220	39	日立EX120-5	57	现代335LC-7
4	PC60-7-80齿	22	SH260	40	日立EX200-5	58	SW200
5	PC120-6(4D102)	23	SH300AI(300A2)	41	日立ZAXIS210LC	59	VOLVO EC210BLC
6	PC120-6(4D95)	24	SH300A3	42	日立EX270	60	ZX230
7	PC100-5	25	CAT320B	43	日立EX300-3	61	佳藤HD450-7
8	PC200-5	26	CAT320C	44	日立EX400-3	62	佳藤HD700-5
9	PC200-6国产	27	CAT320D	45	大宇DH55	63	佳藤HD700-7
10	PC200-6进口	28	CAT320L	46	大宇DH220-3	64	佳藤HD770-1/2
11	PC200-6(6D95)	29	卡特E200B	47	大宇DH220-5	65	佳藤HD820-3
12	PC200-7	30	SK60-3	48	大宇DH255-7	66	山河
13	PC200-7-92齿	31	SK200-3	49	现代55-7	67	柳工
14	PC300-5	32	SK200-6	50	现代60-5	68	Liebherr914/924
15	PC300-6	33	SK200-8	51	现代130LC-3	69	Liebherr934
16	PC400-6	34	SK230-6	52	现代200-5	70	Liebherr944
17	SH120AI	35	SK07-1	53	现代225-7		
18	Sh280	36	SK07-2	54	现代260LC-7		



YEM-H7641



YEM-H7642



YEM-H7643

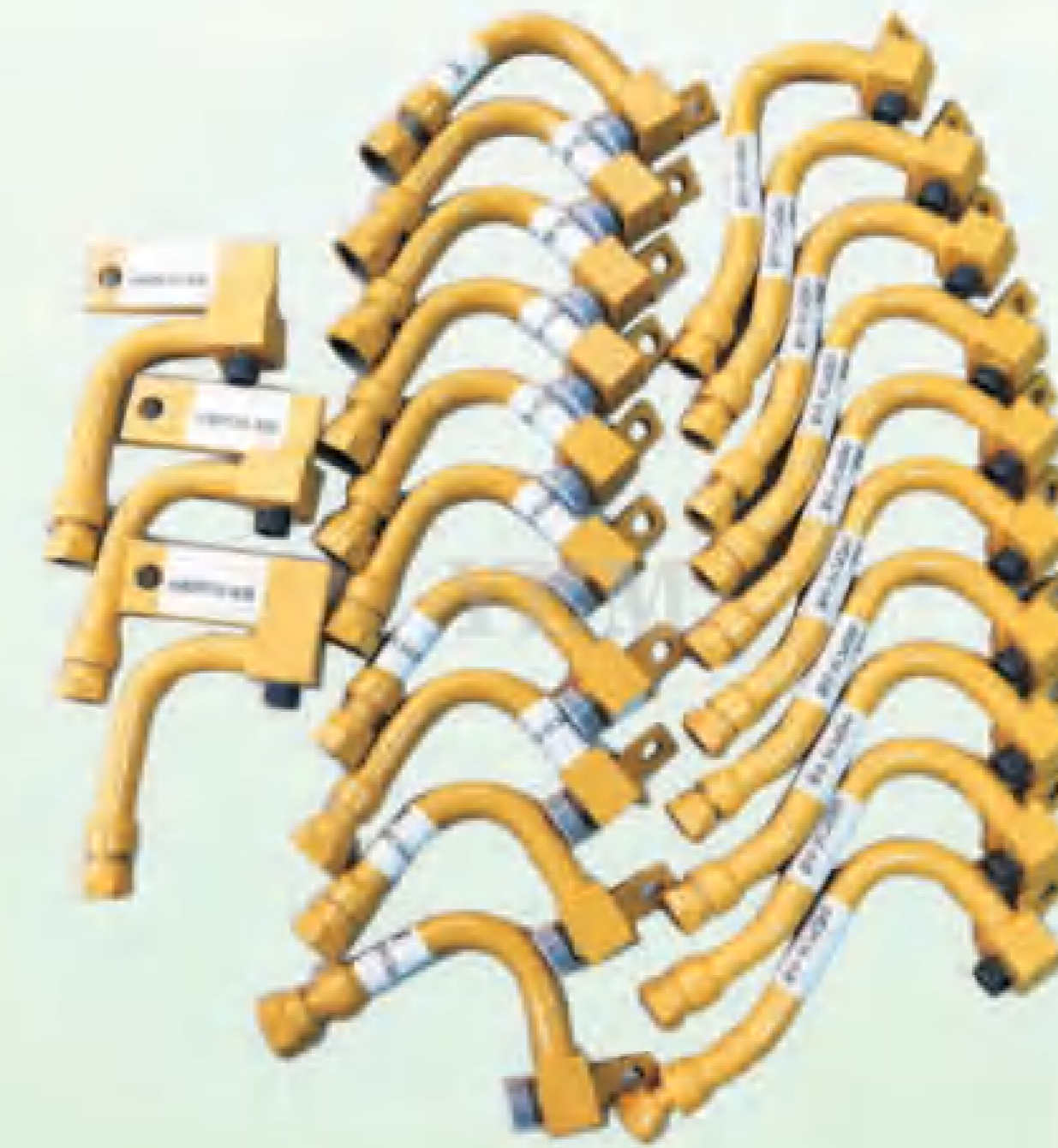

YEM-H7644



YEM-H7645



YEM-H7646



YEM-H7647

链条 TRACK LINK



YEM-H7648

链条规格表

节距	长距	短距	斜距	链通	肖	孔	通用机型
250.35	234.95	184.15	76.5	85.3	57.2	27.4	EX700(47节)
228.6	184	144	76.2	71.5	47	24.4	PC400-6(46节)
216	184	146	76.2	74.3	47	24.4	PC360/400-5/EX400-5 EC360/460 WY160(49节) ZAX450
216	178.4	140	76.5	71	47	22.4	SH330(47节)
216	190	140	76.2	68	46	22.4	E330(45节) CAT235-7 SK300/400
216	184	146	76.2	71	47	22.4	PC400-1/3 DH280/R290
202.8	179	129	72	64	42	20.4	E325/SK300(48节)
203.2	178.4	138.4	72	66.8	44.6	22.4	PC300-5(47节)
203.2	178.4	138.4	72	66.8	44.6	20.4	EX270/300-1/3 DH280/R290(47节)
203.2	186.2	148.2	76.2	66.8	44.6	19.4	R944
190	160.4	124.4	62	59.5	38	20.4	PC200-5 DH220 SW200 HXW200 R220
190	155.6	119	69	58.8	36.6	20.4	E200B/E320/240.SK200.230/SH200 SH340(45节) 瞻阳 ZAX240.5(51节)
190	160.4	124.4	62	59.3	38	18.4	PC200-3/EX200-3/5(46节)
175.5	144.5	125.4	58.7	58.75	36.5	18.4	EX200-1(48节) SH250
175	102.4	86.4	57	46.3	30	16.4	PC100/120/130(40节)
175	158.4	122.4	57	55.3	38	18.4	HD800/770/900(48节)
171.45	144.5	125.4	58.7	54.3	36.65	16.4	R200(50节)
171.45	108	108	60.3	50.8	33.5	16.4	EX100/120 DH120 SH120(43节)
171.45	108	108	60.3	50.3	33.5	14.5	HD400
154	89	73	57	41.2	24	14.4	PC60-6/PC75 柳工907 (38节)
154	112.4	82.4	57	46.3	30	14.4	PC100-1/3 HD350(43节)
154	90	90	55	46.3X89	30X154	14.4	EX60-5
149	84.2	84.2	57	38	25	12.4	CW341/351(37节) ECM350/450
140	86	86	52	37	25.1	12.1	SWE55
140	86	86	52	40	28	14.4	DBC8085/8070
135	99	72	48.2	41	24	12.4	PC60-3/5 DBC8060 SH65 D20 S50 SH60(42节)
135	98.4	74.4	46	35	22.5	12.4	YC60-6/7U45KH25 KX15
135	93.8	63.8	46	35	22.5	12.4	PC40-7/PC45.PC50-7/8/SK040
135	104	80	46	35	22.5	12.4	EX40 EX45
135	88	58	46	35	22.5	12.4	YC35-6/7
135	85	55	46	35	22.5	12.4	PC40-5
101.6	55	55	22	32	19	10.4	EX35 YC35-6/7 IHI30J/SK030
135	106	82	48	35X75	22.5X13	12.4	EX55
135	107	76	48	41.3	24	13	E70B
216	184	146	78	71	47	20.4	R450
135	104	80	47	35X81	22.5X14	13.4	R50/R55 石川島55 SK120.E120通用

履带板 TRACK SHOE



YEM-H7649
履带板 TRACK SHOE



YEM-H7650 斗连杆 BUCKET ROD



YEM-H7651
湿式链板 干式链板系列

YEM-H7652 刀片 刀角系列

引导轮 FRONT IDLER



适用机型

PC60-5、PC100-5、PC120-5、PC200-5、PC200-7、PC300-3/5、PC400、E307、E70B、E110、120B、E312、E200B、E320、E330、E307、E180、E240、E325、E300B、EX55、EX60、EX100、EX120-5、EX200-1、EX200-2、EX200-3、EX200-5、ZX230、ZX240、EX300、EX330、EX400、HD250、HD400、HD450、HD700-5/7、HD770、HD770-2、HD800、HD820、HD1250、HD1880、SK60、SK03、SK06、SK100、SK120、SK200-3/5、SK07N2、SK220、SK230、SK400、SK320、SK350、SH60、SH65、SH100、SH120、SH160、SH200、SH220、SH280、SH260、SH340、SH300、SH350、SH300A2、R50、R55、R60、R130、R200、R210、R215、R220、R225、R290、R300、DH55、DH220、DH50、DH258、DH250、DH280、DH300、YC35、YC65、YC85、EC210、EC240、EC290、EC460、D31、D50、D60

支重轮 TRACK ROLLER

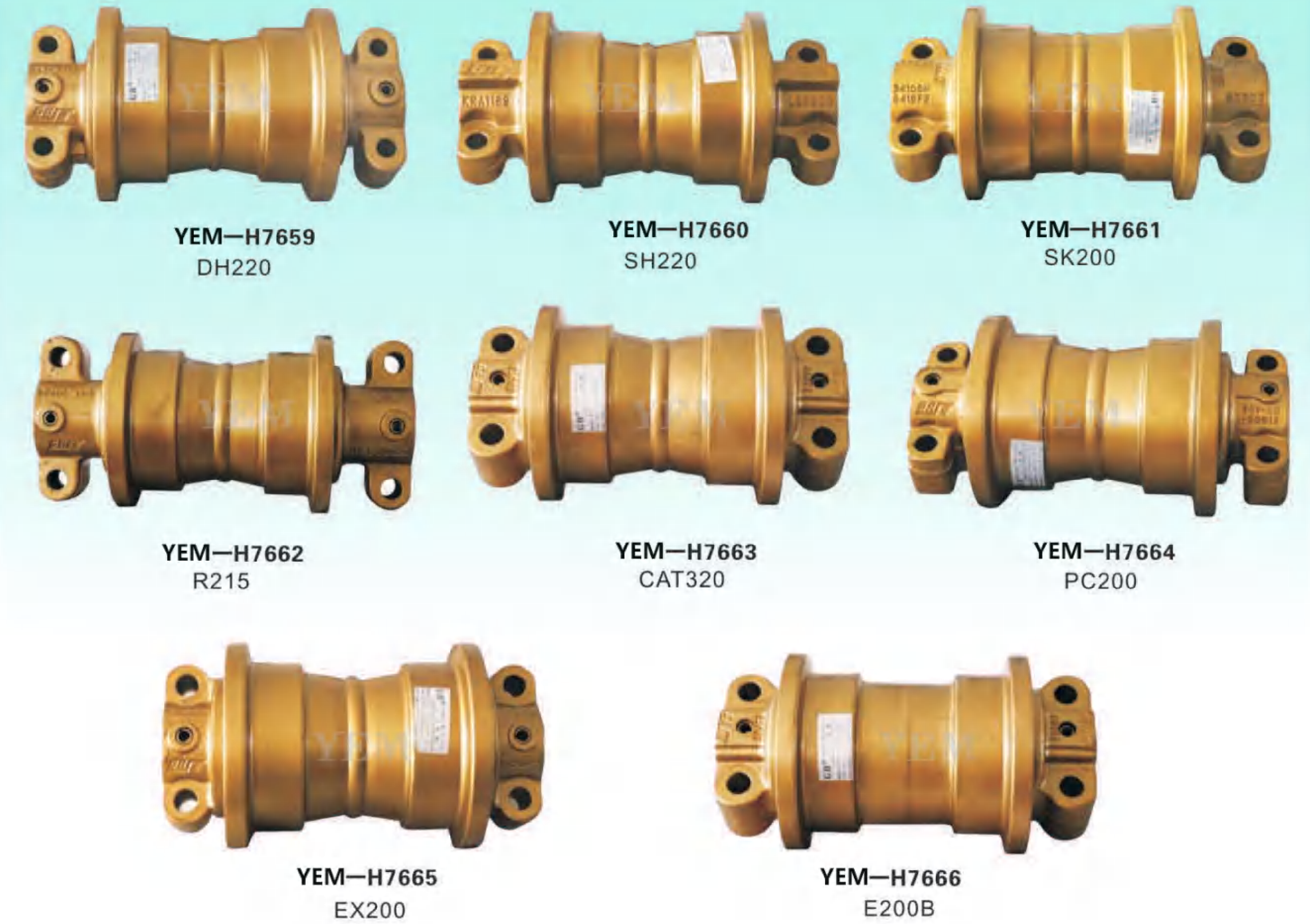

Gb支重轮保质一年

适用机型

PC30、PC40、PC60-1、PC60-3/5、PC60-6、PC100-3/5、PC120-5、P200-1、PC200-3、PC200-5、PC200-7、PC60-7、PC220、PC300-5、PC400-5、20HT、E70B、E110、E120B、E311、E312、E180、E307、E200B、E240、E320、E300B、E325、E330、E460、EX55、EX60、EX70、EX100、EX120、EX200-1、EX200-2、EX200-3/5、EX220、EX230、EX300、EX330、EX350、EX400、HD250、HD400-1、HD420-2、HD450、HD550、HD700、HD770、HD800、HD820、HD1220、HD1250-5/7、HD1430、SK03、SK60、SK100、SK120、SK200-3/5、SK220、SK230、SK300、SK07N2、SK12、SK320、SK350、SH60、SH100、SH120、SH160、SH200、SH260、SH265、SH280、SH220、SH340、SH300、SH300-A2、SH400、SH430、SH580、SH350、DH55、DH130、DH220、DH250、DH258、DH280、DH300、R130、R280、R292、R300、R290、R50、R55、R60、R200、R210、R220、R335、R450、MS180、MS280、EC210、EC290、VH04、VH07、V240、V290、V360、玉柴35、玉柴65、玉柴85、上海T120、宣化T140、D20、D31、D50、D60、D75、D80、D85、抚顺35T、抚顺50T、抚顺70T、山河智能、久保田

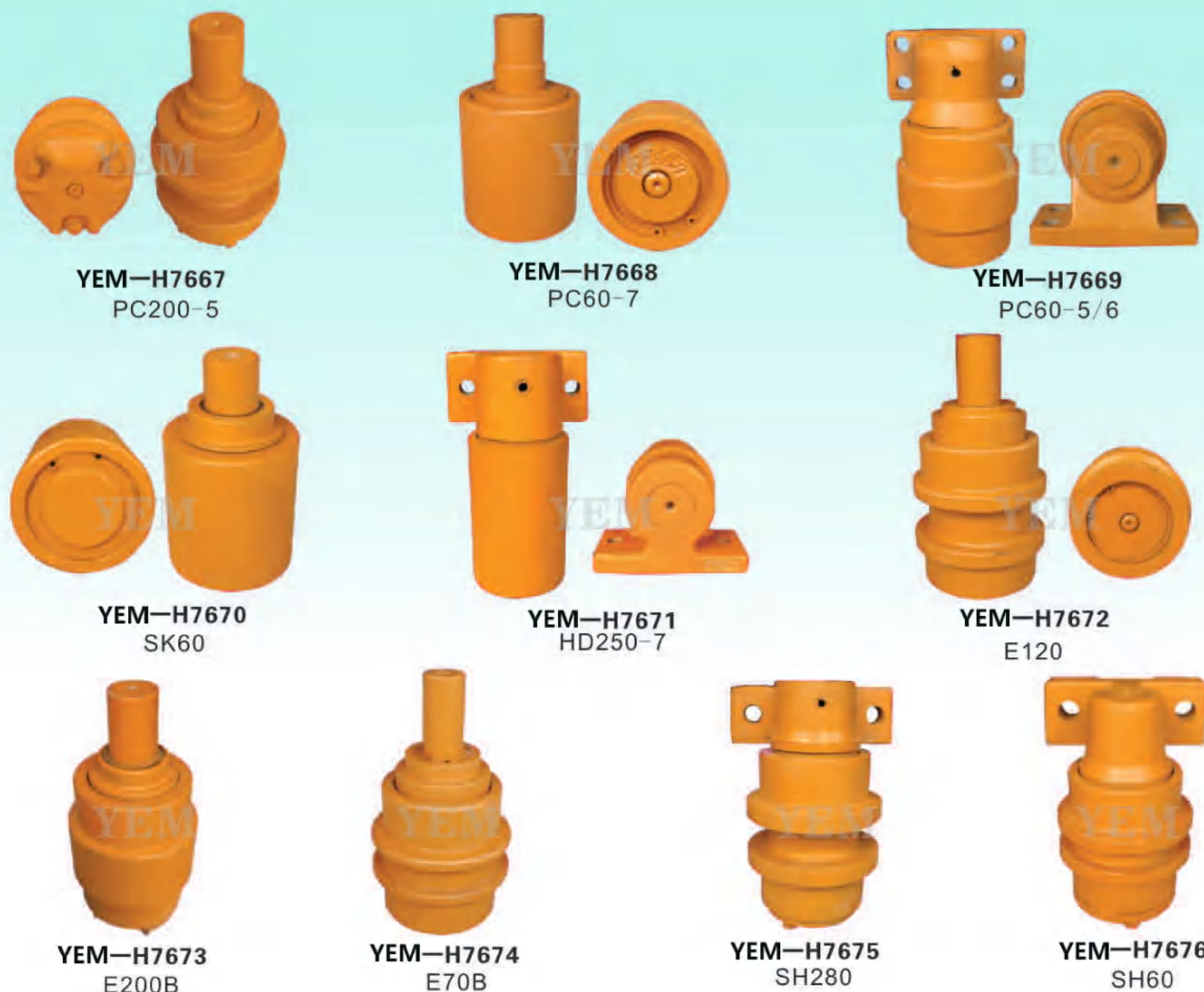

适用机型

PC60-3(胶履带)、PC60-5、PC60-7、PC100-5、PC120、PC200-3/5、PC200-7、PC200-1、PC300-5、20HT、E70B、E100、E120B、E312、E180、E200B、E320、E300B、E307、E280、E325、E330、EX55、EX60、EX70、EX100、EX120、EX200-1、EX200-2、EX200-3/5、EX220、EX230、EX300、EX330、EX350、EX400、VH07-5、VH07-7、HD250、HD400、HD450、HD700、HD770、HD550、HD820、HD1250-5、HD1250-7、SK60、SK100、SK120、SK200-3、SK230、SK200-6、SK220、SK300、SK320、SK07N2、SH60、SH100、SH120、SH200、SH160、SH280、SH265、SH220、SH300、SH340、SH350、DH55、DH220、DH280、DH300、DH258、R50、R55、R60、R130、R200、R210、R220、R290、R300、EC210、EC240、EC290、EC460、玉柴35、玉柴65、玉柴85、D20、D31、D50、D60、D75、D80、D85、上海T120、宣化T140、



适用机型

PC60-1、PC60-3/5、PC60-6、PC60-7、PC100-3、PC100-5、PC120、PC200-1、PC200-3、PC200-5、PC200-6、PC150、PC300-5/6、PC400-5/6、20HT、E70B、E100、E120B、E311、E312、E200B、E180、E320、E240、E300B、E300L、E325、E307、E330、EX30、EX55、EX60、EX100、EX120、EX200-1、EX200-2、EX200-3/5、EX300-1、EX300-3、EX300-5、EX330、EC210、EC240、EC290、EC360、EC460、HD250、HD400、HD450、HD550、HD700-5/7、HD770-2、HD820、HD1250、SK03、SK60、SK100、SK120、SK200-3/5、SK200、SK230、SK07N2、SK310、SK320、SK350、SH60、SH100、SH120、SH200、SH260、SH280、SH300、SH340、SH350、SH430、DH55、DH220、DH280、DH300、DH258、R50、R55、R60、R130、R200、R210、R220、MS180、VH07-7、D20、D31、D50、D60、D75、D85、T120、T140





YEM-H7706

适用机型

PC60、PC100-5、PC120-6、PC200-3/5、PC200-3/5、PC200-3/5、PC200-3/5、PC200-1、PC300-5、PC400、PC300-7、PC120-6、PC40、CAT120、CAT200B、CAT200B、CAT200B、CAT330、EX200-1/2、DH200、EX200-1/2、DH200、EX200-5、EX200-5、EX90、EX120、HD250、HD450、HD700-7、SH120、SH200、SH200、SH280、HD700-5、SK60、SK100、SK120、SK220-3、SK230、ZAX200、ZAX200、HD1250、EX300、D60、SK300、EX200-5/、EX200-1/2、DH220、EX120、DH55、HD450、HD700-7、SH120、SH200、E312、E312、E70B、D50、ZAX200



涨紧油缸 ADJUST CYLINDER

涨紧油缸 ADJUST CYLINDER



涨紧油缸 ADJUST CYLINDER



















挖斗 TEETH SEAT

YEM-H7755  HD450	YEM-H7756  HD700	YEM-H7757  SK60-5	YEM-H7758  SK120-3	YEM-H7759  SK200-5	YEM-H7760  SK220-3
YEM-H7761  SK230	YEM-H7762  SK250	YEM-H7763  SK350-8	YEM-H7764  SH60	YEM-H7765  SH120	YEM-H7766  SH200A3
YEM-H7767  SH280	YEM-H7768  VOL240	YEM-H7769  VOL360	YEM-H7770  YC85	YEM-H7771  VOL210	YEM-H7772  徐工230

YEM-H7773  PC 220	YEM-H7774  PC 200	YEM-H7775  PC360	YEM-H7776  PC120挖斗	
YEM-H7777  PC200 0.8方加强型挖斗	YEM-H7778  PC400 2方岩石斗	YEM-H7779  PC60挖沟斗	YEM-H7780  PC120加强型挖斗	
YEM-H7781  PC60挖斗	YEM-H7782  PC60挖斗加厚型	YEM-H7783  CAT 345	YEM-H7784  CAT 320	
YEM-H7785  E200B 0.8方加强斗	YEM-H7786  DH 420	YEM-H7787  DH 225	YEM-H7788  DH 500	YEM-H7789  DH 370
YEM-H7790  DH55小挖斗	YEM-H7791  DH55	YEM-H7792  VOLVO210	YEM-H7793  EX60土方斗	YEM-H7794  EX650挖斗

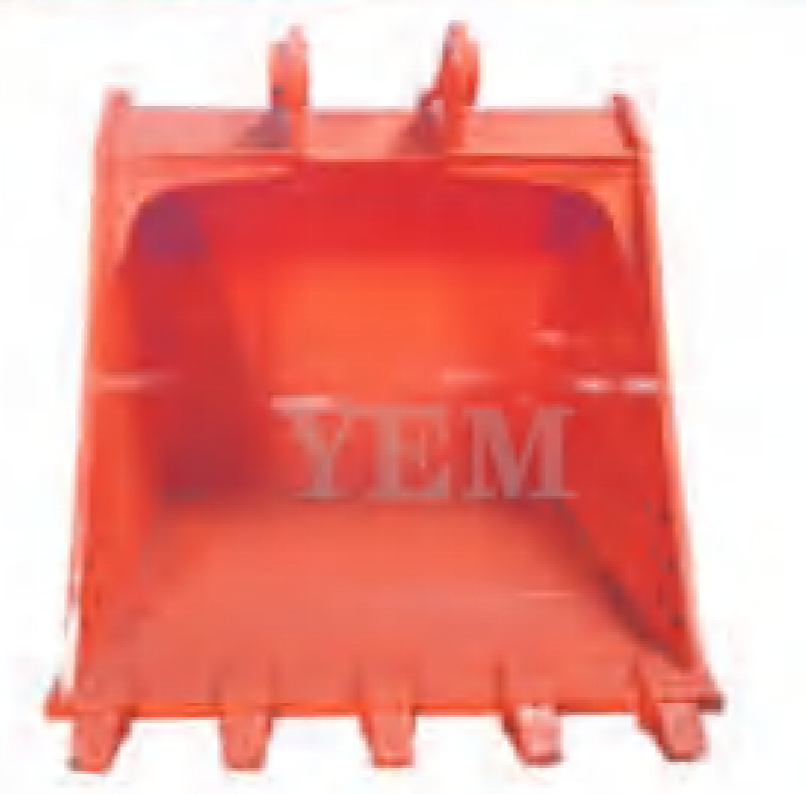
挖斗 TEETH SEAT

高品质斗齿 TEETH AND TEETH SEAT

<p>YEM-H7795</p>  <p>EX 210</p>	<p>YEM-H7796</p>  <p>EX300</p>	<p>YEM-H7797</p>  <p>EX 360</p>	<p>YEM-H7798</p>  <p>EX470</p>
<p>YEM-H7799</p>  <p>EX200 0.8方加强型挖斗</p>	<p>YEM-H7800</p>  <p>ZAX230</p>	<p>YEM-H7801</p>  <p>ZAX 470</p>	<p>YEM-H7802</p>  <p>ZAX200清理斗</p>
<p>YEM-H7803</p>  <p>SK 210</p>	<p>YEM-H7804</p>  <p>SK 230</p>	<p>YEM-H7805</p>  <p>SK 250</p>	<p>YEM-H7806</p>  <p>SK 450</p>
<p>YEM-H7807</p>  <p>R215</p>	<p>YEM-H7808</p>  <p>R305</p>	<p>YEM-H7809</p>  <p>R245</p>	<p>YEM-H7810</p>  <p>HD1032 1.3方</p>
<p>YEM-H7811</p>  <p>HD1430 1.7方</p>	<p>YEM-H7812</p>  <p>三一-205</p>	<p>YEM-H7813</p>  <p>中联</p>	<p>YEM-H7814</p>  <p>久保田</p>

<p>YEM-H7815</p>  <p>卡特斗齿系列 CATERPILLAR</p>	
<p>YEM-H7816</p>  <p>小松斗齿 KOMATSU</p>	<p>YEM-H7817</p>  <p>日立系列 HITACHI</p>
<p>YEM-H7818</p>  <p>JCB系列 JCB</p>	<p>YEM-H7819</p>  <p>神钢系列 KOBELCO</p>
<p>YEM-H7820</p>  <p>现代系列 MYUNDAI</p>	<p>YEM-H7821</p>  <p>大宇系列 DOOSAN</p>

底盘件配件系列
CHASSIS PARTS ACCESSORIES SERIES



轮挖配件 LOADER SPARE PARTS



轮挖配件 LOADER SPARE PARTS

轮挖配件 LOADER SPARE PARTS

YEM-H7858  减速箱磨擦片	YEM-H7859  角齿油封	YEM-H7860  轮毂螺丝	YEM-H7861  连接胶	YEM-H7862  空气干燥器
--	--	--	--	---

YEM-H7863  轮毂油封	YEM-H7864  轮毂油封骨架	YEM-H7865  轮芯油封	YEM-H7866  盆角齿	YEM-H7867  轮胎挡泥片
--	--	--	--	---

YEM-H7868  气压安全阀	YEM-H7869  气压单向阀	YEM-H7870  气压调节阀	YEM-H7871  气压调节阀总成	YEM-H7872  刹车泵修理包配件
--	--	--	---	---

YEM-H7873  刹车分泵总成	YEM-H7874  刹车分泵组件	YEM-H7875  刹车片组件	YEM-H7876  刹车蹄片肖	YEM-H7877  刹车助力泵修理包
--	--	---	--	--

YEM-H7878  中心分油气封	YEM-H7879  中心分油器修理包	YEM-H7880  轴衬套	YEM-H7881  助力泵	YEM-H7882  助力泵修理包
--	--	---	--	--

YEM-H7883  行走减速齿座与外圈	YEM-H7884  传动轴	YEM-H7885  传动轴接头	YEM-H7886  半轴组件配套
---	---	---	--

YEM-H7887  仪表盘	YEM-H7888  大宇150双联泵	YEM-H7889  支架和齿圈	YEM-H7890  150前桥支架
---	--	---	---





















YEM-H7891  行星齿卡片	YEM-H7892  150行星架和前桥半轴	YEM-H7893  150前桥铜套	YEM-H7894  150接头壳	YEM-H7895  盆齿和角齿组件
--	--	--	---	--





















YEM-H7896  前桥轮边组件	YEM-H7897  油门和刹车脚踏阀	YEM-H7898  雨刮器马达	YEM-H7899  小时计和电磁阀阀芯	YEM-H7900  燃油切断阀
--	--	---	---	---

YEM-H7901  组合开关	YEM-H7902  油封	YEM-H7903  行星销和齿、轴承、卡片	YEM-H7904  同步器	YEM-H7905  行星齿、轴承
--	--	---	---	--

挖机模型 EXCAVATOR MODEL





















挖机模型 EXCAVATOR MODEL

<p>YEM-H7906</p>  <p>55214 CAT320DL</p>	<p>YEM-H7907</p>  <p>55215 CAT323DL</p>	<p>YEM-H7908</p>  <p>55058 CAT365BL</p>	<p>YEM-H7909</p>  <p>55305 CAT385CL</p>
<p>YEM-H7910</p>  <p>5541 CAT336DL</p>	<p>YEM-H7911</p>  <p>55160 CAT365CL</p>	<p>YEM-H7912</p>  <p>55274 CAT374D</p>	<p>YEM-H7913</p>  <p>55262 CAT320DL(小)</p>
<p>YEM-H7914</p>  <p>PC1100LC-6</p>	<p>YEM-H7915</p>  <p>PC205 HB205 PC205</p>	<p>YEM-H7916</p>  <p>55080 CAT345B</p>	<p>YEM-H7917</p>  <p>PC210LC UH8003</p>
<p>YEM-H7918</p>  <p>PC450LCD UH8004</p>	<p>YEM-H7919</p>  <p>EC650 VOLVO</p>	<p>YEM-H7920</p>  <p>55125 CAT906</p>	<p>YEM-H7921</p>  <p>利勃海尔 944</p>
<p>YEM-H7922</p>  <p>55196 CAT950H</p>	<p>YEM-H7923</p>  <p>55302 CAT988H</p>	<p>YEM-H7924</p>  <p>55167 CAT272C</p>	<p>YEM-H7925</p>  <p>UH8005 WA70</p>

<p>YEM-H7926</p>  <p>55161 CAT994F</p>	<p>YEM-H7927</p>  <p>HD605</p>	<p>YEM-H7928</p>  <p>VOLVO ECL330C</p>	<p>YEM-H7929</p>  <p>55025V CAT D44R</p>
<p>YEM-H7930</p>  <p>55158 CAT D10T</p>	<p>YEM-H7931</p>  <p>UH8015 WB97S</p>	<p>YEM-H7932</p>  <p>UH8017U</p>	<p>YEM-H7933</p>  <p>55271 CAT416</p>
<p>YEM-H7934</p>  <p>JCB 4CX</p>	<p>YEM-H7935</p>  <p>JCB217S 217S</p>	<p>YEM-H7936</p>  <p>1015 CAT DP125N(叉车)</p>	<p>YEM-H7937</p>  <p>55258 CAT AP655D</p>
<p>YEM-H7938</p>  <p>55286</p>	<p>YEM-H7939</p>  <p>55416</p>	<p>YEM-H7940</p>  <p>55215</p>	<p>YEM-H7941</p>  <p>限量款</p>
<p>YEM-H7942</p>  <p>55502</p>	<p>YEM-H7943</p>  <p>PC200 锤</p>	<p>YEM-H7944</p>  <p>PC200挖机</p>	<p>YEM-H7945</p>  <p>PC200LC挖机</p>

挖机模型 EXCAVATOR MODEL

挖机模型 EXCAVATOR MODEL

<p>YEM-H7946</p>  <p>55134 CAT627G</p>	<p>YEM-H7947</p>  <p>55102 CAT247B2</p>	<p>YEM-H7948</p>  <p>55165 CAT825H</p>	<p>YEM-H7949</p>  <p>55227 CATAP665D</p>
<p>YEM-H7950</p>  <p>555503OV CAT 140H</p>	<p>YEM-H7951</p>  <p>55259 CAT AP600D</p>	<p>YEM-H7952</p>  <p>55154 CAT TWENTY-TWO</p>	<p>YEM-H7953</p>  <p>55303 CAT611</p>
<p>YEM-H7954</p>  <p>55206 CAT797F限量版</p>	<p>YEM-H7955</p>  <p>55243 CAT797F限量版</p>	<p>YEM-H7956</p>  <p>55147 CAT772</p>	<p>YEM-H7957</p>  <p>55301 CAT775E</p>
<p>YEM-H7958</p>  <p>55149 CAT432F组图</p>	<p>YEM-H7959</p>  <p>55115 CAT992G</p>	<p>YEM-H7960</p>  <p>55238 CAT G3516</p>	<p>YEM-H7961</p>  <p>55100 CAT 3516发动机组</p>
<p>YEM-H7962</p>  <p>55502</p>	<p>YEM-H7963</p>  <p>PC200锤</p>	<p>YEM-H7964</p>  <p>PC200 挖机</p>	<p>YEM-H7965</p>  <p>PC200LC 挖机</p>

<p>YEM-H7966</p>  <p>55238</p>	<p>YEM-H7967</p>  <p>55261</p>	<p>YEM-H7968</p>  <p>55224</p>	<p>YEM-H7969</p>  <p>55282</p>
<p>YEM-H7970</p>  <p>55214</p>	<p>YEM-H7971</p>  <p>55203</p>	<p>YEM-H7972</p>  <p>55292</p>	<p>YEM-H7973</p>  <p>55104</p>
<p>YEM-H7974</p>  <p>55108</p>	<p>YEM-H7975</p>  <p>55099</p>	<p>YEM-H7976</p>  <p>55189</p>	<p>YEM-H7977</p>  <p>55199</p>
<p>YEM-H7978</p>  <p>55308-1</p>	<p>YEM-H7979</p>  <p>55308-2</p>	<p>YEM-H7980</p>  <p>55308-3</p>	<p>YEM-H7981</p>  <p>55308-4</p>
<p>YEM-H7982</p>  <p>久保田 绿色</p>	<p>YEM-H7983</p>  <p>久保田 红色</p>	<p>YEM-H7984</p>  <p>旋挖钻机 黄色</p>	<p>YEM-H7985</p>  <p>旋挖钻机 白色</p>



YEM-H7986



YEM-H7987



YEM-H7988



YEM-H7989



YEM-H7990



YEM-H7991



YEM-H7992



YEM-H7993

MODEL /型号	USE FOR /适用于
-K3V63DT	E312B
-SBS80	E312C
-SBS120	E320C/320D
-SBS140	E324D/325D/326D/329D
-K5V160DP	E336D
-K5V200DP	E330D
-K5V200DPH	E345C
-K5V212DPH	E345D/349D

MODEL /型号	USE FOR /适用于
-AP2D36	ZAX120
-HPV102	ZAX200 EX200-5/-6 直喷
-HPV118	ZAX200-3 电喷
-HPV145	ZAX330-1/350/360-1直喷
-HPV145	ZAX330-3 电喷
-K5V200DPH	ZAX450-1 直喷
-K5V200DPH	ZAX470-3 电喷
-K3V63	ZAX450-3/470-3 风扇泵

液压泵HYDRAULIC PUMP



YEM-H7994



YEM-H7995



YEM-H7996



YEM-H7997

MODEL /型号	USE FOR /适用于
· HPV95	PC200-7/220-7
· HPV95	PC200-8
· HPV140	PC360-7

液压泵HYDRAULIC PUMP



YEM-H7998



YEM-H7999

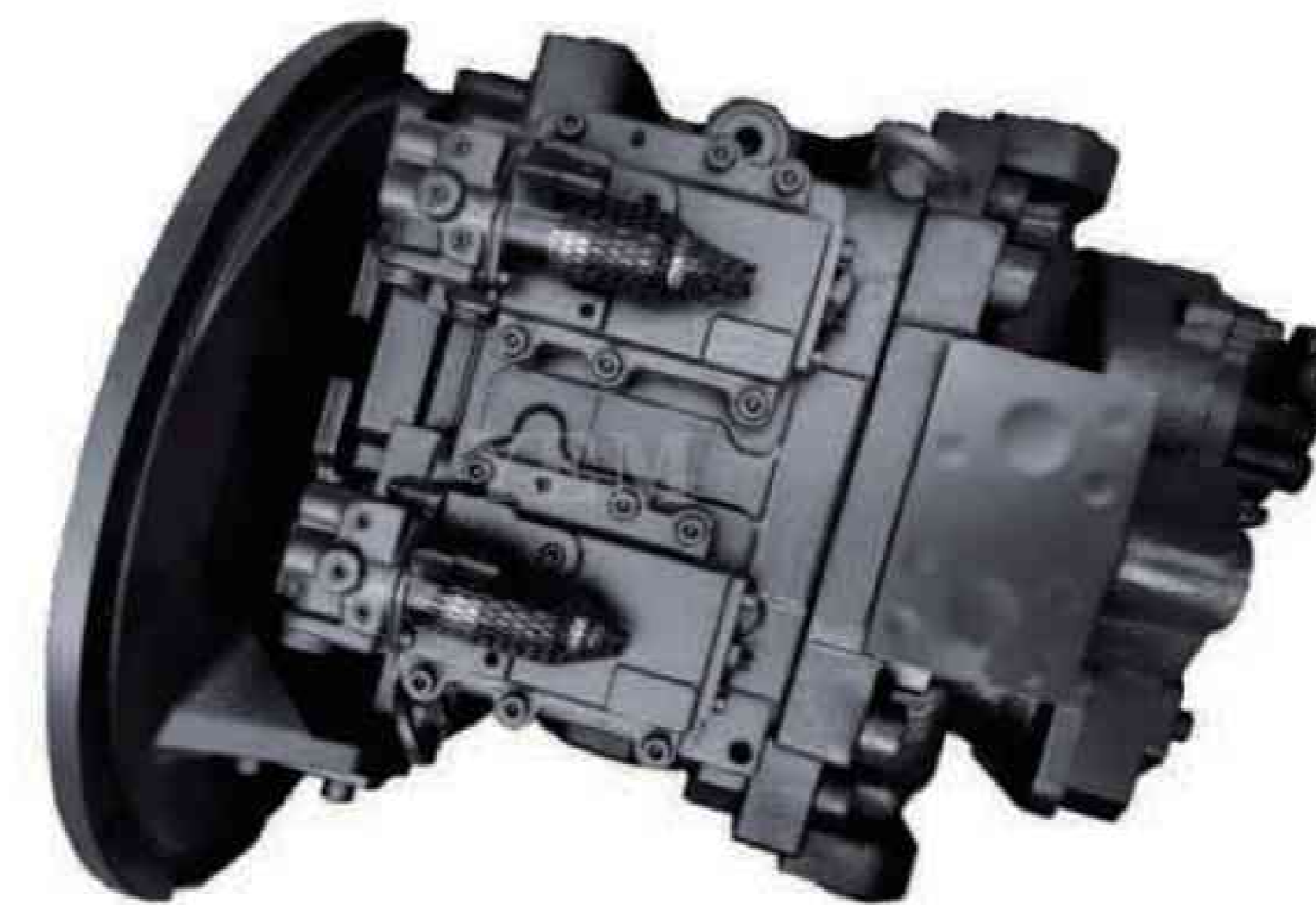

YEM-H8000



YEM-H8001

MODEL /型号	USE FOR /适用于	MODEL /型号	USE FOR /适用于
· K3VL80	SY75	· K3V63DT	SY130/135
· K7V63DTP	SY135	· K3V112DTP	SY205/215 正控
· K3V112DTP	SY205/215	· K3V112DTP	SY205/215 负控
· K3V140DT	SY285	· K3V140DT	SY330/360 负控
· K5V140DTP	SY235	· K5V160DTP	SY335
· K5V160DTH	SY335	· K5V200DTH	SY335/365
· K5V160DTH	SY365/385	· K5V200DTH	SY385-9T /395
· K5V212DPH	SY485	· K7V125DTP	SY245/265
· K5V140DTP	SR285 旋挖	· K3VL28/C	SY485 风扇泵

液压泵HYDRAULIC PUMP

液压泵HYDRAULIC PUMP



YEM-H8002



YEM-H8003



YEM-H8006



YEM-H8007



YEM-H8004



YEM-H8005



YEM-H8008



YEM-H8009

MODEL/型号	USE FOR/适用于	MODEL/型号	USE FOR/适用于
-K3V63DT	EC130/140	-K5V80DT	EC145
-K3V112DT	EC210/210B/240	-K3V112DT	SE240-3/EC240B
-K3V112DT	EC210D	-K3V140DT	EC290
-K5V140DT	EC250D	-K5V160DT	EC300D
-K3V180DT	EC360 (新款)	-K3V180DTP	EC360 (老款)
-K3V180DT	EC380 (新款美制)	-K3V180DT	EC380 (老款)
-K3V180DTH	EC460	-K5V200DTH	EC460
-K5V200DTH	EC480D (老款美制)	-K5V200DTP	EC480D (新款美制)

MODEL /型号	USE FOR/适用于
-K3V112DT	9N00 (14T) 通用款
-K3V112DTP	CX240-5
-K3V112DTP	JS200/210/220/240
-K5V160DTP	CX360
-K3V180DTP	CX460



YEM-H8010



YEM-H8011



YEM-H8014



YEM-H8015



YEM-H8012



YEM-H8013



YEM-H8016



YEM-H8017

MODEL/型号	USE FOR/适用于	MODEL/型号	USE FOR/适用于
- K3V63DT	DX150	- K3V63DT	DH120/S130/150-7
- K3V63DTP	DH150 轮挖	- K5V80DTP	DH150 轮挖
- K3V112DT	S220	- K3V112DT	DH220-5 内泄
- K3V112DT	DH225-7 外泄	- K3V112DT	DH225-7 内外泄通用
- K3V112DTP	DX225	- K3V112DTP	DH225-9 侧面PTO
- K3V112DTP	DX260 侧面PTO	- K3V112DTP	DH258
- K3V140DT	DH280/S280	- K3V140DT	S290/DH300-5
- K5V140DTP	S300-7/DX300	- K3V180DT	DH320
- K3V180DTH	DH400/400-3/450-3	- K5V200DTP	DH500 齿轮泵在中间
- AP2D36	DH80-7	- K5V200DTH	DH500 齿轮泵在后面

MODEL/型号	USE FOR/适用于	MODEL/型号	USE FOR/适用于
- AP2D28	R55/60	- AP2D36	R80
- K3V63DT	R130/150/160	- K3V63DT	R130/140-7
- K5V80DTP	R130/140-7/150	- K5V80DTP	R150 轮挖
- K3V112DT	R215-7/225-7	- K3V112DTP	R215-9T/R225-9T
- K3V112DT	R210-7/220-7	- K3V112DTP	R215-9 正控
- K3V140DT	R290-7	- K3V140DT	R300/320/330/320
- K5V140DTP	R300-7/305LC-7	- K3V180DT	R320-3
- K3V180DT	R320-7/335-7	- K3V180DTH	R350/360-3/385-9T
- K3V180DTH	R360-7/7A	- K3V180DTP	R375/360-7
- K5V200DTH	R455	- K5V200DPH	R500

液压泵HYDRAULIC PUMP



YEM-H8018



YEM-H8019



YEM-H8020



YEM-H8021

液压泵HYDRAULIC PUMP



YEM-H8022



YEM-H8023



YEM-H8024



YEM-H8025

MODEL/型号	USE FOR/适用于	MODEL/型号	USE FOR/适用于
- K3V63DTP	SH130	- K7V63DTP	SH130-5/120A5
- K3V112DT	SH200-1 (12T/14T)	- K3V112DTP	SH200A3
- K3V112DTP	SH200A5/240-5	- K5V140DTP	SH290-5
- K5V140DTP	SH300A3 (12T/14T)	- K5V160DTP	SH300-5/350-5
- K3V180DTP	SH400-3/450-5/460-5	- K5V200DTP	SH480-6

MODEL /型号	USE FOR/适用于
- K3V63DT	HD512
- K3V112DT	HD700/820-1/2/3 (12T/14T)
- K3V112DT	HD820R
- K3V112DT	HD1023III
- K3V180DT	HD1250
- K3V180DT	HD1430/1430-2/-3
- K3V180DTH	HD2045

液压泵HYDRAULIC PUMP



YEM-H8026



YEM-H8027



YEM-H8028



YEM-H8029

MODEL/型号	USE FOR/适用于	MODEL/型号	USE FOR/适用于
- K3SP36B	SK60SR/70SR 无齿轮泵	- K3SP36B	SK60SR/70SR 单齿轮泵
- K3SP36B	SK60SR/70SR 双齿轮泵	- K3V63DTP	SK135SR
- K7V63DTP	SK130-8/140-8	- K5V80DTP	SK200SR
- K3V112DTP	SK200-8/210-8/250-8	- K3V112DTP	SK230-6/6E
- K3V112DTP	SK200-6 铝座	- K3V112DTP	SK200-6 铁座
- K3V112DTP	SK230-6/6E	- K3V112DTP	SK330-6/330-6E
- K5V140DTP	SK330-6/330-6E	- K5V140DTP	SK350-8
- K3V180DTH	SK450-6/450-6E	- K5V200DPH	SK460-8
- K7V125DTP	SK200-10/250-10	- K7V140DTP	SK350-10

微挖泵 MICRO-DIGGING PUMP

YEM-H8030



柱塞泵 PVD-1B-31BP-8AG5
适配机型: 洋马ViO-30-5

YEM-H8031



柱塞泵 PVD-1B-32BP-12G5
适配机型: 洋马ViO30-6

YEM-H8032



柱塞泵 PVD-0B-24P-G3
适配机型: 国内配套

YEM-H8033



柱塞泵 PVD-1B-32P-G8
适配机型: 国内配套

YEM-H8034



柱塞泵 PVD-00B-14P-5G3
适配机型: 久保田15、斗山17、日立17、
临工ER616F

YEM-H8035



柱塞泵 PVD-15B-37P-11G5
适配机型: 久保田U30-6

YEM-H8036



柱塞泵 PVD-00B-18P-6AG4
适配机型: 卡特301.5C CR

YEM-H8037



柱塞泵 PVD-0B-17P-6G3
适配机型: 卡特301.7C CR

YEM-H8038



柱塞泵 PVD-1B-24P-11AG5
适配机型: 欧立德25

YEM-H8039



柱塞泵 PVD-1B-32CP-9AG5
适配机型: 日立ZX-29

YEM-H8040



柱塞泵
适配机型: 三一16C 临工16 徐工15-1

YEM-H8041



柱塞泵
适配机型: 山河智能SWE25UF-8

YEM-H8042



柱塞泵 PVD-0B-12P-5G
适配机型: 山猫E17Z 山猫E20

YEM-H8043



柱塞泵 PVD-00B-16P-6AG3
适配机型: 石川岛18NV

YEM-H8044



柱塞泵 PVD-0B-18B-5
适配机型: 洋马ViO-15

微挖泵 MICRO-DIGGING PUMP

风扇泵 FAN PUMP

YEM-H8045



负载敏感泵-欧力德 适配机型: 国内配套
型号: SA10VSO28DFLR 31R-VSC12N00

YEM-H8046



负载敏感泵-徐工15

YEM-H8047



柱塞泵 PVD-1B-34P-11G5
适配机型: 适用于3-3.5吨机型

YEM-H8048



柱塞泵 PVD-0B-18P-6G3
适配机型: 福田雷沃FR18E2-U

YEM-H8049



柱塞泵
适配机型: 久保田17 神钢SK17-6

YEM-H8050



柱塞泵 PVD-1B-24P-8G3
适配机型: 久保田25 卡特重工ct25

YEM-H8051



柱塞泵 PVD-15B-32P-9AG5
适配机型: 久保田RX306

YEM-H8052



柱塞泵
适配机型: 久保田U-20

YEM-H8053



柱塞泵 PVD-0B-19P-6G3
适配机型: 卡特302C CR

YEM-H8054



柱塞泵 PVD-1B-28P-8AG4
适配机型: 卡特303C CR

YEM-H8055



柱塞泵 PVD-1B-32CP-11G5
适配机型: 日立U-30-5

YEM-H8056



柱塞泵 PVD-1B-32CP-8AG5
适配机型: 日立U30-6

YEM-H8057



柱塞泵 PVD-1B-32P-11G5
适配机型: 日立ZX-27

YEM-H8058



柱塞泵 PVD-0B-16BP-6AG4
适配机型: 洋马VIO-17

YEM-H8059



柱塞泵 PVD-1B-24BP-8AG5
适配机型: 洋马VIO27-5B

YEM-H8060



170-9918

YEM-H8061



卡特345GC
件号: 524-0924

YEM-H8062



9T6857

YEM-H8063



307-3063

YEM-H8064



307-3063

YEM-H8065



250-8337

YEM-H8066



168-9027

YEM-H8067



204-2578

YEM-H8068



卡特950G 962G
风扇泵191-2942

YEM-H8069



254-5146

YEM-H8070



323187-9090-3618

YEM-H8071



209-3258

YEM-H8072



235-2716

YEM-H8073



254-5146

YEM-H8074



254-5147

YEM-H8075



E365C风扇马达

YEM-H8076



247-8968

YEM-H8077



247-8968

YEM-H8078



184-7448

YEM-H8079



350-0666

风扇泵 FAN PUMP

<p>YEM-H8080</p>  <p>VOE 11190766</p>	<p>YEM-H8081</p>  <p>VOE 11707966</p>	<p>YEM-H8082</p>  <p>VOE 11707968</p>	<p>YEM-H8083</p>  <p>VOE 11707969</p>
<p>YEM-H8084</p>  <p>VOE 11708991</p>	<p>YEM-H8085</p>  <p>VOE 15020177</p>	<p>YEM-H8086</p>  <p>VOE 15140666</p>	<p>YEM-H8087</p>  <p>VOE 15191773</p>
<p>YEM-H8088</p>  <p>VOE 17458121</p>	<p>YEM-H8089</p>  <p>VOE 17458128</p>	<p>YEM-H8090</p>  <p>VOE 17487754.17458125</p>	<p>YEM-H8091</p>  <p>VOE15020156</p>
<p>YEM-H8092</p>  <p>VOE 11117046</p>	<p>YEM-H8093</p>  <p>徐工700风扇泵 派克改款</p>	<p>YEM-H8094</p>  <p>DX700风扇泵</p>	<p>YEM-H8095</p>  <p>柳工950派克款风扇泵</p>
<p>YEM-H8096</p>  <p>三一485风扇泵</p>	<p>YEM-H8097</p>  <p>徐工490卡帕萨款</p>	<p>YEM-H8098</p>  <p>约翰迪尔 AL166639/R902445445</p>	<p>YEM-H8099</p>  <p>徐工490风扇泵 派克款</p>

风扇马达 FAN MOTOR

<p>YEM-H8100</p>  <p>E365C 385B 390D风扇马达</p>	<p>YEM-H8101</p>  <p>E385C风扇马达225-4613</p>	<p>YEM-H8102</p>  <p>230-7965</p>	<p>YEM-H8103</p>  <p>E345GC风扇马达</p>
<p>YEM-H8104</p>  <p>E345C风扇马达</p>	<p>YEM-H8105</p>  <p>CAT 247-8978</p>	<p>YEM-H8106</p>  <p>136-8869</p>	<p>YEM-H8107</p>  <p>200-3252</p>
<p>YEM-H8108</p>  <p>255-6805</p>	<p>YEM-H8109</p>  <p>徐工490 柳工950叶片款</p>	<p>YEM-H8110</p>  <p>徐工490 柳工950柱塞款</p>	<p>YEM-H8111</p>  <p>VOE 11130338</p>
<p>YEM-H8112</p>  <p>E345B风扇马达</p>	<p>YEM-H8113</p>  <p>VOLVO 11410665</p>	<p>YEM-H8114</p>  <p>ZAX470新款改老款</p>	<p>YEM-H8115</p>  <p>斗山520风扇马达</p>
<p>YEM-H8116</p>  <p>福田480风扇马达</p>	<p>YEM-H8117</p>  <p>柳工950凯斯帕</p>	<p>YEM-H8118</p>  <p>E330D 336D风扇马达座</p>	<p>YEM-H8119</p>  <p>E345D风扇马达座</p>
<p>YEM-H8120</p>  <p>三一485齿轮款</p>	<p>YEM-H8121</p>  <p>三一485风扇马达</p>	<p>YEM-H8122</p>  <p>VOLVO360 新款风扇马达 14505903</p>	<p>YEM-H8123</p>  <p>VOLVO360 新款风扇马达 14505903</p>

风扇马达 FAN MOTOR

回转装置(微挖)
ROTARY DEVICE (MICRO EXCAVATION)

<p>YEM-H8124</p>  <p>DX380风扇马达</p>	<p>YEM-H8125</p>  <p>307-3036</p>	<p>YEM-H8126</p>  <p>PC800-8风扇马达</p>	<p>YEM-H8127</p>  <p>MSF53</p>
<p>YEM-H8128</p>  <p>MMF-044D</p>	<p>YEM-H8129</p>  <p>R480风扇泵31QB-30130</p>	<p>YEM-H8130</p>  <p>160-0196/8J5846</p>	<p>YEM-H8131</p>  <p>VOLVO老款单泵 14524186</p>
<p>YEM-H8132</p>  <p>VOLVO700C 三联14515182</p>	<p>YEM-H8133</p>  <p>VOLVO四联14515182</p>	<p>YEM-H8134</p>  <p>4P-5638</p>	<p>YEM-H8135</p>  <p>4P-5638</p>
<p>YEM-H8136</p>  <p>3799986</p>	<p>YEM-H8137</p>  <p>37080762</p>	<p>YEM-H8138</p>  <p>323-3618</p>	<p>YEM-H8139</p>  <p>313-7770</p>
<p>YEM-H8140</p>  <p>313-7770</p>	<p>YEM-H8141</p>  <p>160-0196/8J5846</p>	<p>YEM-H8142</p>  <p>1880128</p>	<p>YEM-H8143</p>  <p>1668331</p>
<p>YEM-H8144</p>  <p>徐工490风扇泵 派克改款</p>	<p>YEM-H8145</p>  <p>11410665风扇马达</p>	<p>YEM-H8146</p>  <p>徐工490新款风扇马达</p>	<p>YEM-H8147</p>  <p>徐工490柱塞款风扇马达</p>

<p>YEM-H8148</p>  <p>回转装置 德力南特嘉和犀牛山河韩泰</p>	<p>YEM-H8149</p>  <p>回转装置 德力南特嘉和犀牛山河韩泰 195</p>	<p>YEM-H8150</p>  <p>回转装置 2.5K-245-恒特20 山河智能20德力20欧力德17</p>	<p>YEM-H8151</p>  <p>回转装置 适用机型：久保田10</p>
<p>YEM-H8152</p>  <p>回转装置 适用机型：久保田15 久保田17</p>	<p>YEM-H8153</p>  <p>回转装置 适用机型：久保田15 久保田17</p>	<p>YEM-H8154</p>  <p>回转装置 适用机型：卡特303.5</p>	<p>YEM-H8155</p>  <p>回转装置 适用机型：三一55</p>
<p>YEM-H8156</p>  <p>回转装置 适用机型：三一26 徐工XE26</p>	<p>YEM-H8157</p>  <p>回转装置 适用机型：山猫20</p>	<p>YEM-H8158</p>  <p>回转装置 神钢15 神钢17 山河智能 三一16</p>	<p>YEM-H8159</p>  <p>回转装置 适用机型：石川岛18</p>
<p>YEM-H8160</p>  <p>回转装置 适用机型：威克诺森17 卡特301.7</p>	<p>YEM-H8161</p>  <p>回转装置 适用机型：小松18</p>	<p>YEM-H8162</p>  <p>回转装置 适用机型：徐工15</p>	<p>YEM-H8163</p>  <p>回转装置 适用机型：徐工35 玉柴35-7</p>

回转装置(微挖)
ROTARY DEVICE (MICRO EXCAVATION)

分油中 OIL SEPARATION

YEM-H8164



回转装置
适用机型: 洋马17

YEM-H8165



回转装置
适用机型: 洋马20

YEM-H8166



回转装置
适用机型: 玉柴13-8

YEM-H8167



Zx450 Zx470
ZX650 回转中心接头

YEM-H8168



ZAX55 ZAX60
回转中心接头

YEM-H8169



PC360-7
回转中心接头

YEM-H8170



PC300-7
回转中心接头

YEM-H8171



PC210-8MO
回转中心接头

YEM-H8180



SK120-1/2/3/5
回转中心接头

YEM-H8181



R215-7
回转中心接头

YEM-H8182



Ec360
回转中心接头

YEM-H8183



EC210B
回转中心接头

YEM-H8172



PC200-6 Lg6225
回转中心接头

YEM-H8173



PC60-8
回转中心接头

YEM-H8174



E320D
回转中心接头

YEM-H8175



E312B E313C
回转中心接头

YEM-H8188



Sh100 SH120A2
回转中心接头

YEM-H8189



Dh55 Dh60
斗山 回转中心接头

YEM-H8190



DH60-7
斗山 回转中心接头

YEM-H8191



Dh150 Dh215
DH300-7 回转中心接头

YEM-H8176



E308C
回转中心接头

YEM-H8177



E307B E70B
回转中心接头

YEM-H8178



E306 E305
E305.5 回转中心接头

YEM-H8179



SK200-5
回转中心接头

YEM-H8192



DH225-7
斗山 回转中心接头

YEM-H8193



SY75C
回转中心接头

YEM-H8194



力士德 Sc80

YEM-H8195



力士德 SC210LC

YEM-H8196



JCB80
回转中心接头(不带铲)

YEM-H8197



JCB8056
回转中心接头

YEM-H8198



CLG205C CL225
回转中心接头

YEM-H8199



CLG915D
回转中心接头

YEM-H8200



CLG925D
回转中心接头

YEM-H8201



LG220C
回转中心接头

YEM-H8202



LG906
回转中心接头

YEM-H8203



LG936
回转中心接头

YEM-H8204



LG6065
回转中心接头

YEM-H8205



LG6150
回转中心接头

YEM-H8206



XE80
回转中心接头

YEM-H8207



YC15
回转中心接头

YEM-H8208



YC35
回转中心接头

YEM-H8209



YC60 YC65-8
回转中心接头

YEM-H8210



转向阀

YEM-H8211



正反手

YEM-H8212



1P80

YEM-H8213



1P80气控

YEM-H8214



2P80

YEM-H8215



2P80电气控

YEM-H8216



1P5ZT20

YEM-H8217



1PZT12

YEM-H8218



1PZD102

YEM-H8219



1PZDA15

YEM-H8220



SD14

YEM-H8221



1PZDA15气控

YEM-H8222



1P40

YEM-H8223



2P40

YEM-H8224



2P120

YEM-H8225



2PSD8

YEM-H8226



2PSD11

YEM-H8227





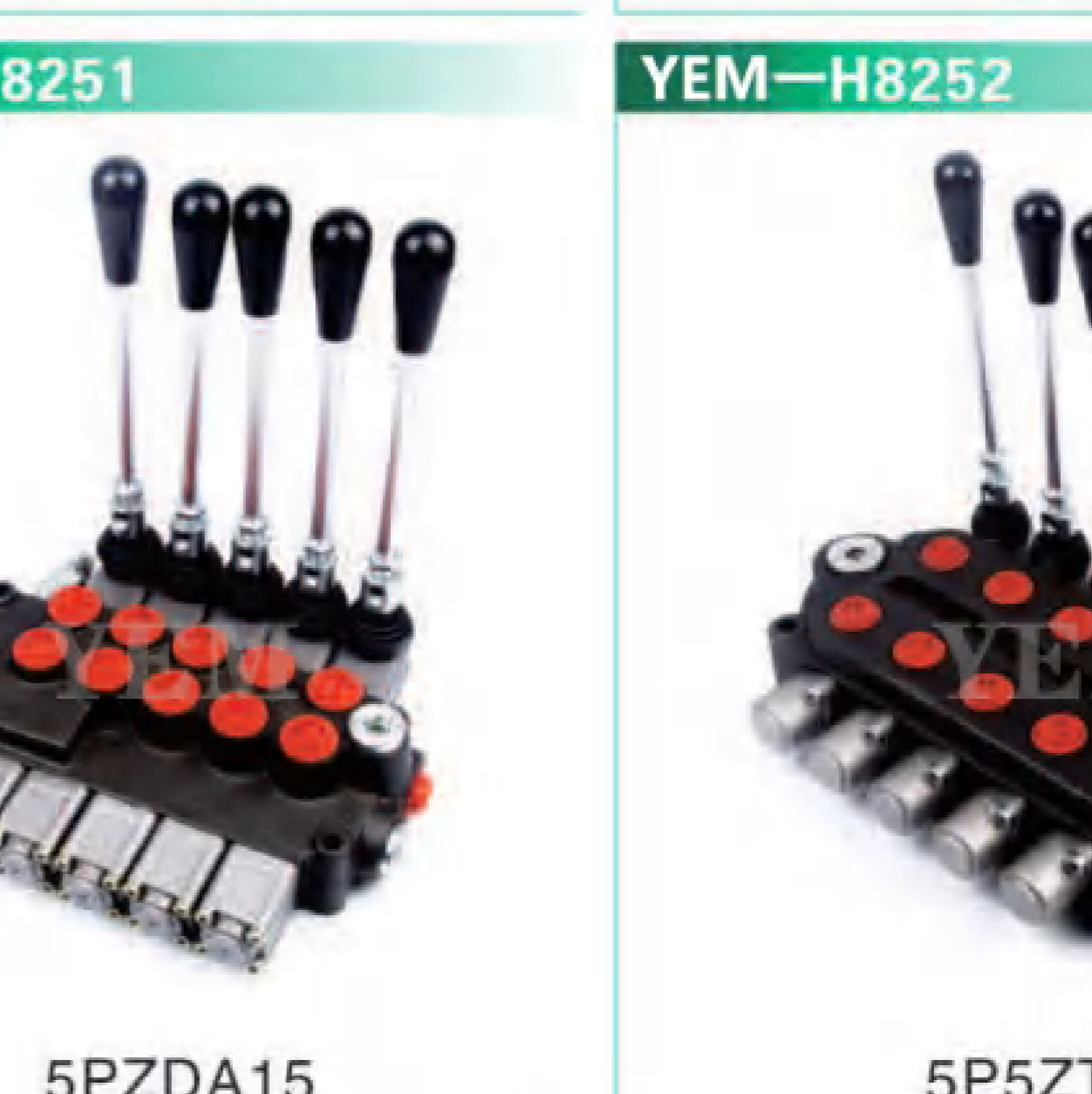
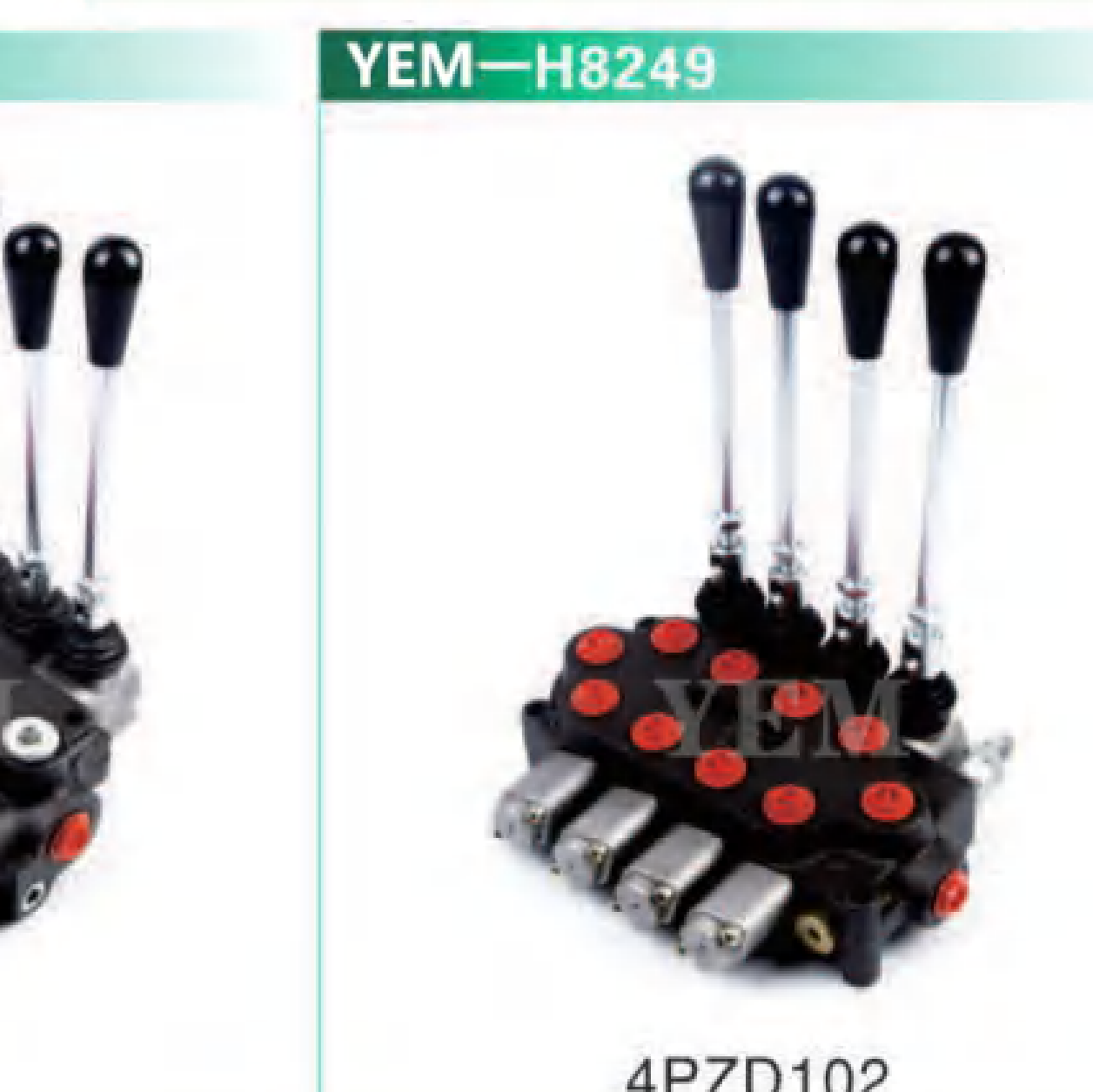
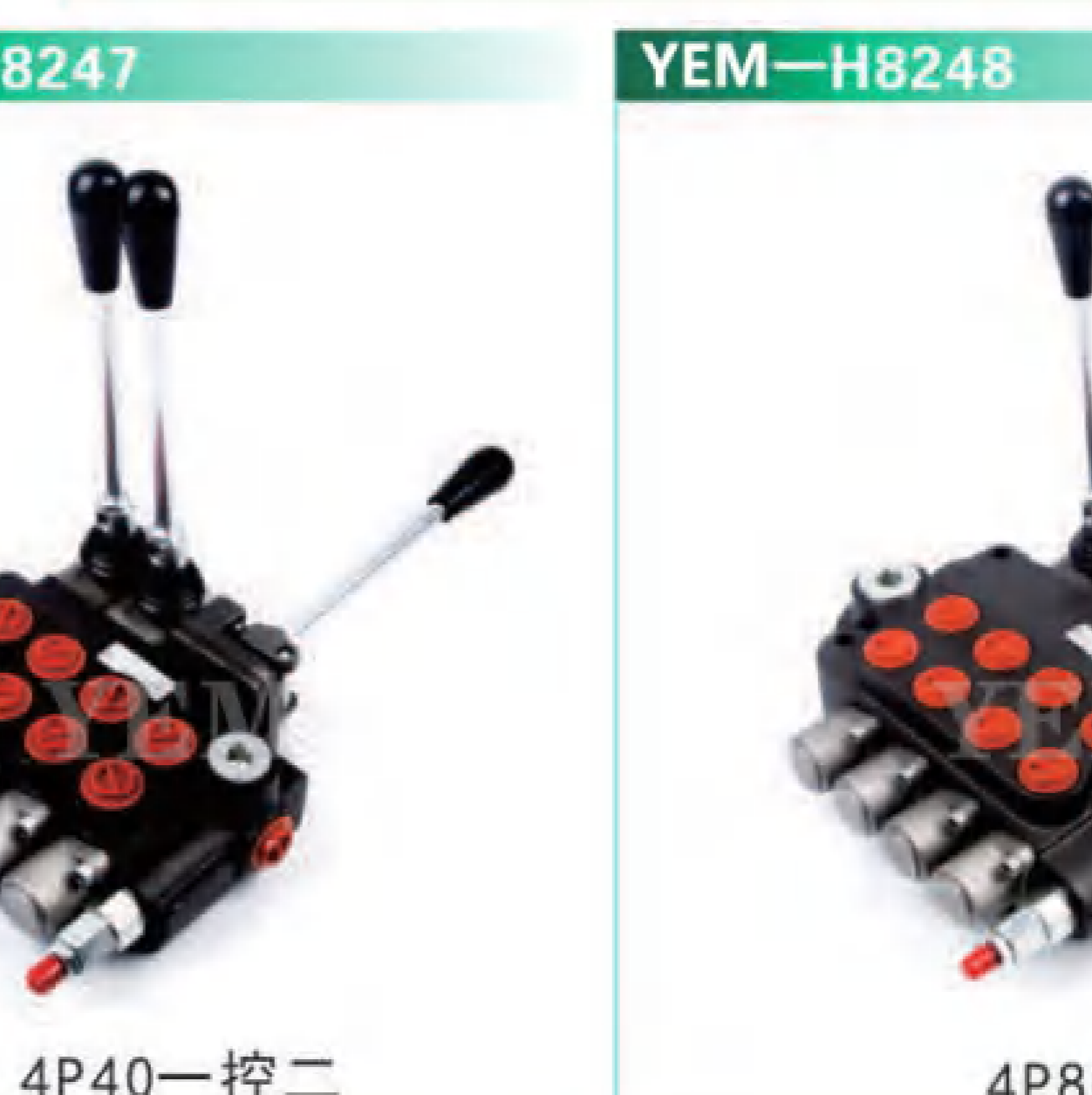

















2PZD102





<p>YEM-H8290</p>  <p>JCB 20902900 液压泵</p>	<p>YEM-H8291</p>  <p>JCB 20925580 液压泵</p>	<p>YEM-H8292</p>  <p>15RA保持阀</p>	<p>YEM-H8293</p>  <p>PC200-6大臂保持阀</p>
<p>YEM-H8294</p>  <p>川崎防摆阀</p>	<p>YEM-H8295</p>  <p>19J067A 保持阀</p>	<p>YEM-H8296</p>  <p>PC400-7208222</p>	<p>YEM-H8297</p>  <p>EC210小臂合流阀</p>
<p>YEM-H8298</p>  <p>15RB 大小臂蜗牛阀</p>	<p>YEM-H8299</p>  <p>KMX32 保持阀</p>	<p>YEM-H8300</p>  <p>15RB优先阀</p>	<p>YEM-H8301</p>  <p>斗山保持阀</p>
<p>YEM-H8302</p>  <p>PC300-7保持阀</p>	<p>YEM-H8303</p>  <p>保持阀</p>	<p>YEM-H8304</p>  <p>小松PC360高阀保持阀</p>	<p>YEM-H8305</p>  <p>KYB保持阀</p>
<p>YEM-H8306</p>  <p>PC110-7</p>	<p>YEM-H8307</p>  <p>PC110-7大臂保持阀</p>	<p>YEM-H8308</p>  <p>VOLVO 大臂保持阀</p>	<p>YEM-H8309</p>  <p>19G016A</p>

<p>YEM-H8310</p>  <p>PC200-8MO 合分流阀</p>	<p>YEM-H8311</p>  <p>PC360-7 PC阀</p>	<p>YEM-H8312</p>  <p>PC360-7 PC阀总成</p>	<p>YEM-H8313</p>  <p>保持阀</p>
<p>YEM-H8314</p>  <p>龙工225小臂保持阀</p>	<p>YEM-H8315</p>  <p>PC160-7 自减压阀块 REDUCCING VALVE</p>	<p>YEM-H8316</p>  <p>PC130-7四孔 自减压阀块 REDUCCING VALVE</p>	<p>YEM-H8317</p>  <p>4分截止阀 Φ60</p>
<p>YEM-H8318</p>  <p>4分截止阀 Φ70</p>	<p>YEM-H8319</p>  <p>4分截止阀 Φ80</p>	<p>YEM-H8320</p>  <p>4分截止阀</p>	<p>YEM-H8321</p>  <p>卡特专用截止阀 12孔 孔中心距80</p>
<p>YEM-H8322</p>  <p>卡特专用截止阀 17孔 孔中心距75</p>	<p>YEM-H8323</p>  <p>久保田专用截止阀 70*40*50 10孔</p>	<p>YEM-H8324</p>  <p>三一专用扁体球阀 13孔, 孔中心距60</p>	<p>YEM-H8325</p>  <p>三一扁体截止阀 14孔, 孔中心距70</p>
<p>YEM-H8326</p>  <p>临工500截止阀 20孔</p>	<p>YEM-H8327</p>  <p>斗山专用截止阀 17孔, 孔中心距80</p>	<p>YEM-H8328</p>  <p>临工/沃尔沃专用截止阀 16孔, 孔中心距85</p>	<p>YEM-H8329</p>  <p>1.2寸球阀</p>

<p>YEM-H8330</p>  <p>E330D E336D E345D</p>	<p>YEM-H8331</p>  <p>神钢460-8 ZX450</p>	<p>YEM-H8332</p>  <p>4N4864 先导泵</p>	<p>YEM-H8333</p>  <p>4N4873 先导泵</p>
<p>YEM-H8334</p>  <p>705-17-01610</p>	<p>YEM-H8335</p>  <p>705-17-04611</p>	<p>YEM-H8336</p>  <p>K3SP36B</p>	<p>YEM-H8337</p>  <p>K3SP36C</p>
<p>YEM-H8338</p>  <p>K7SP36</p>	<p>YEM-H8339</p>  <p>K3V63BDT</p>	<p>YEM-H8340</p>  <p>K5V80</p>	<p>YEM-H8341</p>  <p>K3V63DT</p>
<p>YEM-H8342</p>  <p>K3V63DTP</p>	<p>YEM-H8343</p>  <p>K7V63</p>	<p>YEM-H8344</p>  <p>K3VL80</p>	<p>YEM-H8345</p>  <p>K3V112DT</p>
<p>YEM-H8346</p>  <p>K5V140</p>	<p>YEM-H8347</p>  <p>K3V112B DT</p>	<p>YEM-H8348</p>  <p>K3V180</p>	<p>YEM-H8349</p>  <p>K5V200左右泵</p>

<p>YEM-H8350</p>  <p>K5V200前后泵</p>	<p>YEM-H8351</p>  <p>K5V200</p>	<p>YEM-H8352</p>  <p>SBS80</p>	<p>YEM-H8353</p>  <p>SBS120</p>	<p>YEM-H8354</p>  <p>HPV132</p>
<p>YEM-H8355</p>  <p>HPV95</p>	<p>YEM-H8356</p>  <p>SBS180</p>	<p>YEM-H8357</p>  <p>K7V125</p>	<p>YEM-H8358</p>  <p>K7V280</p>	<p>YEM-H8359</p>  <p>20Y-60-222331 分配器单向阀 PC200-6/7/三一</p>
<p>YEM-H8360</p>  <p>PC200-8分配器大 分配器单向阀大 PC200-8</p>	<p>YEM-H8361</p>  <p>PC200-8分配器小 分配器单向阀小 PC200-8</p>	<p>YEM-H8362</p>  <p>YN30V00101S517 分配器单向阀大 SK200-8/SK300</p>	<p>YEM-H8363</p>  <p>YN30V00101S518 分配器单向阀小 SK200-8/SK300</p>	<p>YEM-H8364</p>  <p>回转马达单向阀 M5X150 170</p>
<p>YEM-H8365</p>  <p>回转马达单向阀 M5X180</p>	<p>YEM-H8366</p>  <p>回转马达单向阀 PC-6-7-8</p>	<p>YEM-H8367</p>  <p>回转马达单向阀 PC-7带字母</p>	<p>YEM-H8368</p>  <p>回转马达单向阀 PC200-6-7</p>	<p>YEM-H8369</p>  <p>回转马达单向阀 PC200-8</p>
<p>YEM-H8370</p>  <p>回转马达单向阀 SG08(7132D)</p>	<p>YEM-H8371</p>  <p>回转马达单向阀 SG08 (7162D)</p>	<p>YEM-H8372</p>  <p>PC360PC阀调节杆</p>	<p>YEM-H8373</p>  <p>PC200-7PC阀调节杆</p>	<p>YEM-H8374</p>  <p>PC200-8PC阀调节杆</p>

YEM-H8375



YEM-H8376



YEM-H8377



YEM-H8378



YEM-H8379



YEM-H8380



YEM-H8381



YEM-H8382



YEM-H8383

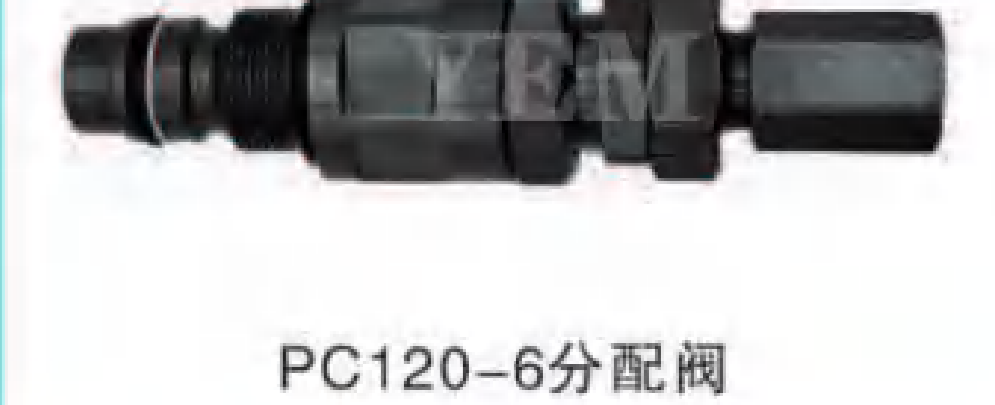

YEM-H8384



YEM-H8385



YEM-H8386



YEM-H8387



YEM-H8388



YEM-H8389



YEM-H8390



YEM-H8391



YEM-H8392



YEM-H8393



YEM-H8394



YEM-H8395



YEM-H8396



YEM-H8397



YEM-H8398



YEM-H8399



YEM-H8400



YEM-H8401



YEM-H8402



YEM-H8403



主炮/副炮 MAIN/SERVICE VALVE

YEM-H8404  EX200-5副阀	YEM-H8405  EX200-6行走	YEM-H8406  EX220-3行走	YEM-H8407  CAT70B 副阀
YEM-H8408  CAT200B回转	YEM-H8409  CAT307D卸荷阀	YEM-H8410  CAT312 行走	YEM-H8411  CAT330D主阀
YEM-H8412  CAT330主阀	YEM-H8413  CAT336D 主阀	YEM-H8414  CAT345 166-3648副阀	YEM-H8415  R215-7主阀
YEM-H8416  R215W-7行走	YEM-H8417  R450副阀	YEM-H8418  SH120副阀	YEM-H8419  SH 行走
YEM-H8420  R行走	YEM-H8421  SK60-3主阀	YEM-H8422  SK60-5副阀	YEM-H8423  SK75-8主调
YEM-H8424  SK200行走	YEM-H8425  EC290主阀	YEM-H8426  EC360回转	YEM-H8427  EC360主阀
YEM-H8428  EC360主阀	YEM-H8429  EC460副阀	YEM-H8430  EC460 行走	YEM-H8431  EC460主阀
YEM-H8432  EC480主阀	YEM-H8433  EC单向阀	YEM-H8434  DH HD 单向阀	YEM-H8435  DH130-7回转

主炮/副炮 MAIN/SERVICE VALVE

YEM-H8436  DH150-7 行走	YEM-H8437  DH220-5泵控阀	YEM-H8438  DH225-7 行走	YEM-H8439  DH500主阀
YEM-H8440  DX60回转	YEM-H8441  DX380主阀	YEM-H8442  HD250先导阀	YEM-H8443  HD820副阀
YEM-H8444  YC35 (不带针)	YEM-H8445  YC35(带针)	YEM-H8446  YC85 回转	YEM-H8447  柳工907 副阀
YEM-H8448  柳工907主阀	YEM-H8449  KYB行走	YEM-H8450  KYB回转	YEM-H8451  SH60副阀
YEM-H8452  SY75 主阀	YEM-H8453  单向阀	YEM-H8454  徐工210 主阀	YEM-H8455  洋马15 主阀
YEM-H8456  帝人行走	YEM-H8457  东方60 主阀	YEM-H8458  合流阀	YEM-H8459  凯斯55 回转
YEM-H8460  雷沃60主阀	YEM-H8461  力士乐 副阀	YEM-H8462  力士乐 主阀	YEM-H8463  龙工80行走
YEM-H8464  派克280副阀	YEM-H8465  炮机阀	YEM-H8466  山河智能50 副阀	YEM-H8467  徐工80主阀

单向阀 CHECK VALVE

<p>YEM-H8468</p>  <p>LV-12-5-15 回油单向阀1.5 SY305</p>	<p>YEM-H8469</p>  <p>LV-12-40 回油单向阀4.0 SY305</p>	<p>YEM-H8470</p>  <p>129-8034 回油单向阀3.0 E320B/330B</p>	<p>YEM-H8471</p>  <p>E330C 回油单向阀3.0 E330C/E325D/E329D/336D</p>
<p>YEM-H8472</p>  <p>352-7160 回油单向阀4.0 E330D/345D/349D/C9</p>	<p>YEM-H8473</p>  <p>335-0374 回油单向阀3.0 E330D/345D/349D/C9</p>	<p>YEM-H8474</p>  <p>E70/DH450 2.5 回油单向阀2.5 E70/DH450</p>	<p>YEM-H8475</p>  <p>E70/DH450 5.0 回油单向阀5.0 E70/DH450</p>
<p>YEM-H8476</p>  <p>YN21V00015P1 回油滤芯单向阀 SK250-8</p>	<p>YEM-H8477</p>  <p>SK350 回油滤芯单向阀 SK350-8</p>	<p>YEM-H8478</p>  <p>ZAX330 回油滤芯单向阀 ZAX330电喷</p>	<p>YEM-H8479</p>  <p>徐工小挖 回油单向阀 徐工小挖</p>
<p>YEM-H8480</p>  <p>徐工60 1.5 回油单向阀1.5 徐工60</p>	<p>YEM-H8481</p>  <p>徐工60 3.0 回油单向阀3.0 徐工60</p>	<p>YEM-H8482</p>  <p>龙工485/徐工 2.5 回油单向阀2.5 龙工485/徐工</p>	<p>YEM-H8483</p>  <p>龙工485/徐工 4.5 回油单向阀4.5 龙工485/徐工</p>
<p>YEM-H8484</p>  <p>SK250-6 2.5 回油单向阀2.5</p>	<p>YEM-H8485</p>  <p>SK250-6 5.0 回油单向阀5.0</p>	<p>YEM-H8486</p>  <p>SK320/330 2.5 回油单向阀2.5 SK320/330/350-6/8</p>	<p>YEM-H8487</p>  <p>SK320/330 5.0 回油单向阀5.0 SK320/330/350-6/8</p>
<p>YEM-H8488</p>  <p>SK120/135 2.0回油单向阀2.0 SK120/135</p>	<p>YEM-H8489</p>  <p>SK120/135 5.0 回油单向阀5.0 SK120/135</p>	<p>YEM-H8490</p>  <p>2436R576F1 回油单向阀2.5 SK75/60</p>	<p>YEM-H8491</p>  <p>SK75 5.0 回油单向阀5.0 SK75/60</p>















单向阀 CHECK VALVE

<p>YEM-H8492</p>  <p>1903264761 回油单向阀1.5 柳工936E</p>	<p>YEM-H8493</p>  <p>1901043545 回油单向阀4.5 柳工936E</p>	<p>YEM-H8494</p>  <p>14673208 回油单向阀1.5 VOLVO210</p>	<p>YEM-H8495</p>  <p>SY365/385 4.5 回油单向阀总成4.5 SY365/385/465/485</p>
<p>YEM-H8496</p>  <p>SY365/385 2.5 回油单向阀总成2.5 SY365/385/465/485</p>	<p>YEM-H8497</p>  <p>SY385/485 4.5 回油单向阀4.5</p>	<p>YEM-H8498</p>  <p>DH700 2.0 回油单向阀总成2.0 DH700</p>	<p>YEM-H8499</p>  <p>410128-00031 旁通阀 262/311</p>
<p>YEM-H8500</p>  <p>卡特312 回油单向阀 (底压) E312B/C</p>	<p>YEM-H8501</p>  <p>卡特312 回油单向阀 (高压) E312C/D</p>	<p>YEM-H8502</p>  <p>629-93900001 回油单向阀2.0 HD820</p>	<p>YEM-H8503</p>  <p>669-61200010 回油单向阀6.0 HD1023</p>
<p>YEM-H8504</p>  <p>669-53800001 回油单向阀2.0 HD1023</p>	<p>YEM-H8505</p>  <p>094-6526 回油单向阀3.0 E200B/320V2</p>	<p>YEM-H8506</p>  <p>现代 回油单向阀1.5 R150-7/335-7/E307/JCB</p>	<p>YEM-H8507</p>  <p>现代 回油单向阀3.0 R150-7/335-7/E307/JCB</p>
<p>YEM-H8508</p>  <p>14672144 回油单向阀 VOLVO/临工460</p>	<p>YEM-H8509</p>  <p>JCB/现代 回油单向阀5.0 JCB/现代</p>	<p>YEM-H8510</p>  <p>PC200-7回油单向阀 (高压) PC200-7</p>	<p>YEM-H8511</p>  <p>PC200-7 回油单向阀 (底压) PC200-7</p>
<p>YEM-H8512</p>  <p>PC200-6 回油单向阀5.0 PC200-6</p>	<p>YEM-H8513</p>  <p>PC200-6 回油单向阀2.5 PC200-6</p>	<p>YEM-H8514</p>  <p>老款VOLVO360 回油单向阀3.0 VOLVO360/ZAX650</p>	<p>YEM-H8515</p>  <p>老款VOLVO360 回油单向阀4.5 VOLVO360</p>

单向阀 CHECK VALVE





















<p>YEM-H8516</p>  <p>回油单向阀 回油单向阀5.0 SH460/凯斯460</p>	<p>YEM-H8517</p>  <p>回油单向阀 回油单向阀1.5 SH460/凯斯460</p>	<p>YEM-H8518</p>  <p>4255212 回油单向阀1.0 ZAXIS70</p>	<p>YEM-H8519</p>  <p>ZAXIS70 5.0 回油单向阀5.0 ZAXIS70</p>
<p>YEM-H8520</p>  <p>4266481 回油单向阀4.0 ZAX120</p>	<p>YEM-H8521</p>  <p>255-3084 回油单向阀总成3.0 E307D</p>	<p>YEM-H8522</p>  <p>E370D 2.0 回油单向阀总成2.0 E370D</p>	<p>YEM-H8523</p>  <p>LV-12-30A 回油单向阀总成3.0 JCM370/JCB370</p>
<p>YEM-H8524</p>  <p>LV-16-20A 回油单向阀总成2.0 HD700</p>	<p>YEM-H8525</p>  <p>SY60/75/95 回油单向阀总成6.0 SY60/75/95</p>	<p>YEM-H8526</p>  <p>SY60/75/95 回油单向阀总成2.5 SY60/75/95</p>	<p>YEM-H8527</p>  <p>SY60/75/95 回油单向阀6.0 SY60/75/95</p>
<p>YEM-H8528</p>  <p>SY60/75/95 回油单向阀2.5 SY60/75/95</p>	<p>YEM-H8529</p>  <p>PC200 散热器单向阀 PC200-8</p>	<p>YEM-H8530</p>  <p>207-03-71290 散热器单向阀 PC300/360</p>	<p>YEM-H8531</p>  <p>829-050500 回油单向阀 (低压) 玉柴130/230</p>
<p>YEM-H8532</p>  <p>885-0511000 回油单向阀 (高压) 玉柴130/230</p>	<p>YEM-H8533</p>  <p>870E-0558000 回油单向阀 (底压) 玉柴360</p>	<p>YEM-H8534</p>  <p>895-0506400 回油单向阀 (高压) 玉柴360</p>	<p>YEM-H8535</p>  <p>厦工 回油单向阀 (低压) 厦工815/DH80</p>
<p>YEM-H8536</p>  <p>厦工 回油单向阀 (高压) 厦工815/DH80</p>	<p>YEM-H8537</p>  <p>厦工822 回油单向阀 (低压) 厦工822/XG8250-9</p>	<p>YEM-H8538</p>  <p>厦工822 回油单向阀 (高压) 厦工822/XG8250-9</p>	<p>YEM-H8539</p>  <p>E312D 回油单向阀3.0 E312D</p>

单向阀 CHECK VALVE

<p>YEM-H8540</p>  <p>E308 回油单向阀3.0 E308</p>	<p>YEM-H8541</p>  <p>SK200/22007N2 回油单向阀2.0 SK200/220/07N2</p>	<p>YEM-H8542</p>  <p>SK200-3 2.5 回油单向阀2.5 SK200-30</p>	<p>YEM-H8543</p>  <p>SK200-3 5.0 回油单向阀5.0 SK200-3</p>
<p>YEM-H8544</p>  <p>HD1430-3 2.0 回油单向阀2.0 HD1430-3</p>	<p>YEM-H8545</p>  <p>HD1430-3 5.0 回油单向阀5.0 HD1430-3/HD2045</p>	<p>YEM-H8546</p>  <p>12C0867 回油单向阀总成1.0 柳工915C/915D</p>	<p>YEM-H8547</p>  <p>12C0866 回油单向阀3.0 柳工915C/915D</p>
<p>YEM-H8548</p>  <p>DX260 1.0 回油单向阀1.0 DX260</p>	<p>YEM-H8549</p>  <p>DX260 3.0 回油单向阀3.0 DX260</p>	<p>YEM-H8550</p>  <p>HD512 5.0 回油单向阀5.0 HD512</p>	<p>YEM-H8551</p>  <p>HD512 2.0 回油单向阀2.0 HD512</p>
<p>YEM-H8552</p>  <p>EX60 3.0 回油单向阀3.0 EX60</p>	<p>YEM-H8553</p>  <p>E320B 回油单向阀4.0 E320B</p>	<p>YEM-H8554</p>  <p>竹内135低压 回油单向阀1.5 竹内135</p>	<p>YEM-H8555</p>  <p>竹内135高压 回油单向阀5.0 竹内135</p>
<p>YEM-H8556</p>  <p>EC380 3.0 回油单向阀半总成 EC380</p>	<p>YEM-H8557</p>  <p>EC380 4.5 回油单向阀半总成 EC380</p>	<p>YEM-H8558</p>  <p>JCB360 5.0 回油单向阀5.0 JCB360</p>	<p>YEM-H8559</p>  <p>JCB360 1.0 回油单向阀1.0 JCB360</p>
<p>YEM-H8560</p>  <p>YA00001408 回油单向阀1.5 ZX330-5A</p>	<p>YEM-H8561</p>  <p>山东卡特 2.5 回油单向阀2.5 山东卡特</p>	<p>YEM-H8562</p>  <p>山东卡特 4.5 回油单向阀4.5 山东卡特</p>	<p>YEM-H8563</p>  <p>中联360 回油单向阀2.5 中联360</p>

手柄总成 HANDLE ASSEMBLY

手柄总成 HANDLE ASSEMBLY

<p>YEM-H8564</p>  <p>CAT E320GC 487-8455</p>	<p>YEM-H8565</p>  <p>CAT 307-3990</p>	<p>YEM-H8566</p>  <p>PC电控</p>	<p>YEM-H8567</p>  <p>307-3993 E345 374F</p>
<p>YEM-H8568</p>  <p>CAT988H 950H 953D 307-4671</p>	<p>YEM-H8569</p>  <p>D31手柄总成</p>	<p>YEM-H8570</p>  <p>CAT D5R2 D6N D8T 424-8511</p>	<p>YEM-H8571</p>  <p>川崎8孔手柄总成</p>
<p>YEM-H8572</p>  <p>EC250E 300E 350E 14788531</p>	<p>YEM-H8573</p>  <p>R225-9RVS</p>	<p>YEM-H8574</p>  <p>推土机</p>	<p>YEM-H8575</p>  <p>EX-2 通用款</p>
<p>YEM-H8576</p>  <p>EX-1通用款</p>	<p>YEM-H8577</p>  <p>EX200-2</p>	<p>YEM-H8578</p>  <p>E303 306E马蹄形</p>	<p>YEM-H8579</p>  <p>E303 306E圆形</p>
<p>YEM-H8580</p>  <p>SK75 久保田161 竹内175马蹄形</p>	<p>YEM-H8581</p>  <p>洋马手柄总成</p>	<p>YEM-H8582</p>  <p>CAT950GC 966GC装载机</p>	<p>YEM-H8583</p>  <p>山猫20</p>

<p>YEM-H8584</p>  <p>R60-5</p>	<p>YEM-H8585</p>  <p>掘进机</p>	<p>YEM-H8586</p>  <p>PC200-5</p>	<p>YEM-H8587</p>  <p>HD820-3</p>
<p>YEM-H8588</p>  <p>旋挖单键</p>	<p>YEM-H8589</p>  <p>旋挖 三键</p>	<p>YEM-H8590</p>  <p>旋挖 四键</p>	<p>YEM-H8591</p>  <p>SK75 久保田161 竹内175圆形</p>
<p>YEM-H8592</p>  <p>ZAX-5G手柄总成</p>	<p>YEM-H8593</p>  <p>HC-RCL-60110190DD</p>	<p>YEM-H8594</p>  <p>PC120-3-5</p>	<p>YEM-H8595</p>  <p>沃尔沃SD25D SD45D 12778130</p>
<p>YEM-H8596</p>  <p>PC200-6 带铁杆</p>	<p>YEM-H8597</p>  <p>SH210A5 4线 手柄胶</p>	<p>YEM-H8598</p>  <p>R-7 手柄胶</p>	<p>YEM-H8599</p>  <p>R-7 新款</p>
<p>YEM-H8600</p>  <p>R轮控</p>	<p>YEM-H8601</p>  <p>E320D 320GC</p>	<p>YEM-H8602</p>  <p>VOLVO</p>	<p>YEM-H8603</p>  <p>川崎 专用</p>

脚踏阀 FOOT VALVE

<p>YEM-H8604</p>  <p>E365C E374D 247-5275</p>	<p>YEM-H8605</p>  <p>卡特M313 M315 598-0003</p>	<p>YEM-H8606</p>  <p>派克刹车阀</p>	<p>YEM-H8607</p>  <p>E320GC 破碎锤490-1013</p>
<p>YEM-H8608</p>  <p>R60-9</p>	<p>YEM-H8609</p>  <p>R215-9</p>	<p>YEM-H8610</p>  <p>E320B新款</p>	<p>YEM-H8611</p>  <p>CAT E320GC 1490-1012</p>
<p>YEM-H8612</p>  <p>CAT E320GC</p>	<p>YEM-H8613</p>  <p>脚踏阀 CAT950GC 370-8728</p>	<p>YEM-H8614</p>  <p>M313轮挖脚踏阀 521-1696</p>	<p>YEM-H8615</p>  <p>PC-8-10破碎锤脚踏阀</p>
<p>YEM-H8616</p>  <p>SK200-3脚踏阀</p>	<p>YEM-H8617</p>  <p>轮挖脚踏阀</p>	<p>YEM-H8618</p>  <p>破碎锤行走</p>	<p>YEM-H8619</p>  <p>KOMATSU 电子油门</p>
<p>YEM-H8620</p>  <p>三一/中联电子油门踏板总成</p>	<p>YEM-H8621</p>  <p>SK250-8新款</p>	<p>YEM-H8622</p>  <p>SK-8/力士乐</p>	<p>YEM-H8623</p>  <p>SK-8/力士乐</p>

脚踏阀 FOOT VALVE

<p>YEM-H8624</p>  <p>PC 脚踏阀压板</p>	<p>YEM-H8625</p>  <p>SK75/DX60行走子弹头座</p>	<p>YEM-H8626</p>  <p>DH-7 R-7子弹头座</p>	<p>YEM-H8627</p>  <p>E200B SK-3-5行走子弹头座</p>
<p>YEM-H8628</p>  <p>E320C 320D老款行走子弹头座</p>	<p>YEM-H8629</p>  <p>E320C 320D新款行走子弹头座</p>	<p>YEM-H8630</p>  <p>R-5行走子弹头座</p>	<p>YEM-H8631</p>  <p>SK-6E行走子弹头座</p>
<p>YEM-H8632</p>  <p>力士乐 手柄压板</p>	<p>YEM-H8633</p>  <p>JCB</p>	<p>YEM-H8634</p>  <p>久保田NEW</p>	<p>YEM-H8635</p>  <p>卡特 E225 出口版</p>
<p>YEM-H8636</p>  <p>洋马55/75手柄</p>	<p>YEM-H8637</p>  <p>洋马 徐工60专用行走</p>	<p>YEM-H8638</p>  <p>洋马</p>	<p>YEM-H8639</p>  <p>山河70专用</p>
<p>YEM-H8640</p>  <p>Φ20*35mm 破碎锤 炮机子弹头</p>	<p>YEM-H8641</p>  <p>Φ20*41mm 破碎锤 炮机子弹头</p>	<p>YEM-H8642</p>  <p>Φ20*40mm 破碎锤 炮机子弹头</p>	<p>YEM-H8643</p>  <p>Φ16*38mm 破碎锤 炮机子弹头</p>

YEM 组件

起动马达 STARTING MOTOR



YEM-H8644 4HK1组件



YEM-H8645 4HK1组件



YEM-H8646 4TNV94组件



YEM-H8647 6D114组件



YEM-H8648 4TNV94组件

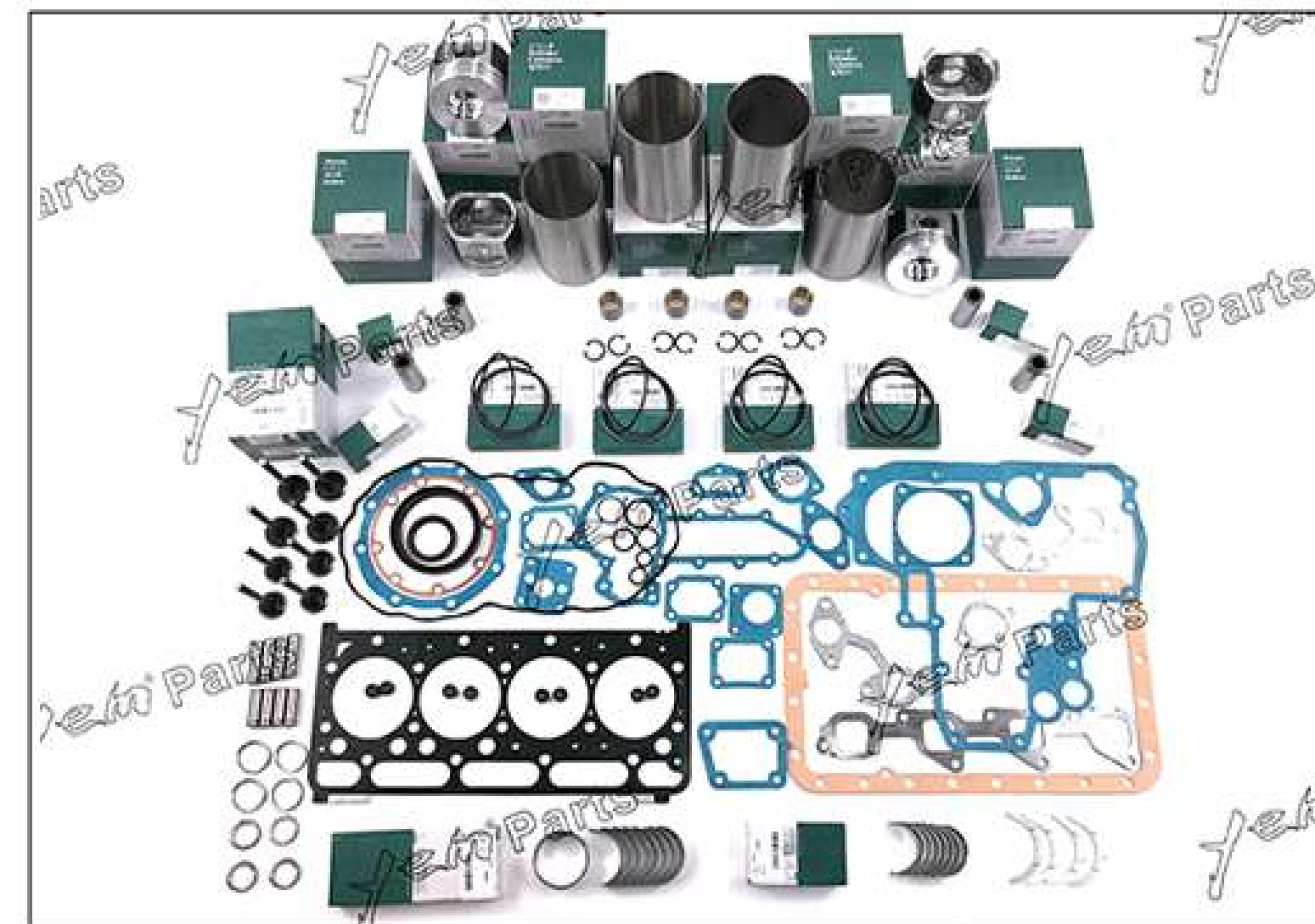

YEM-H8649 D7E组件

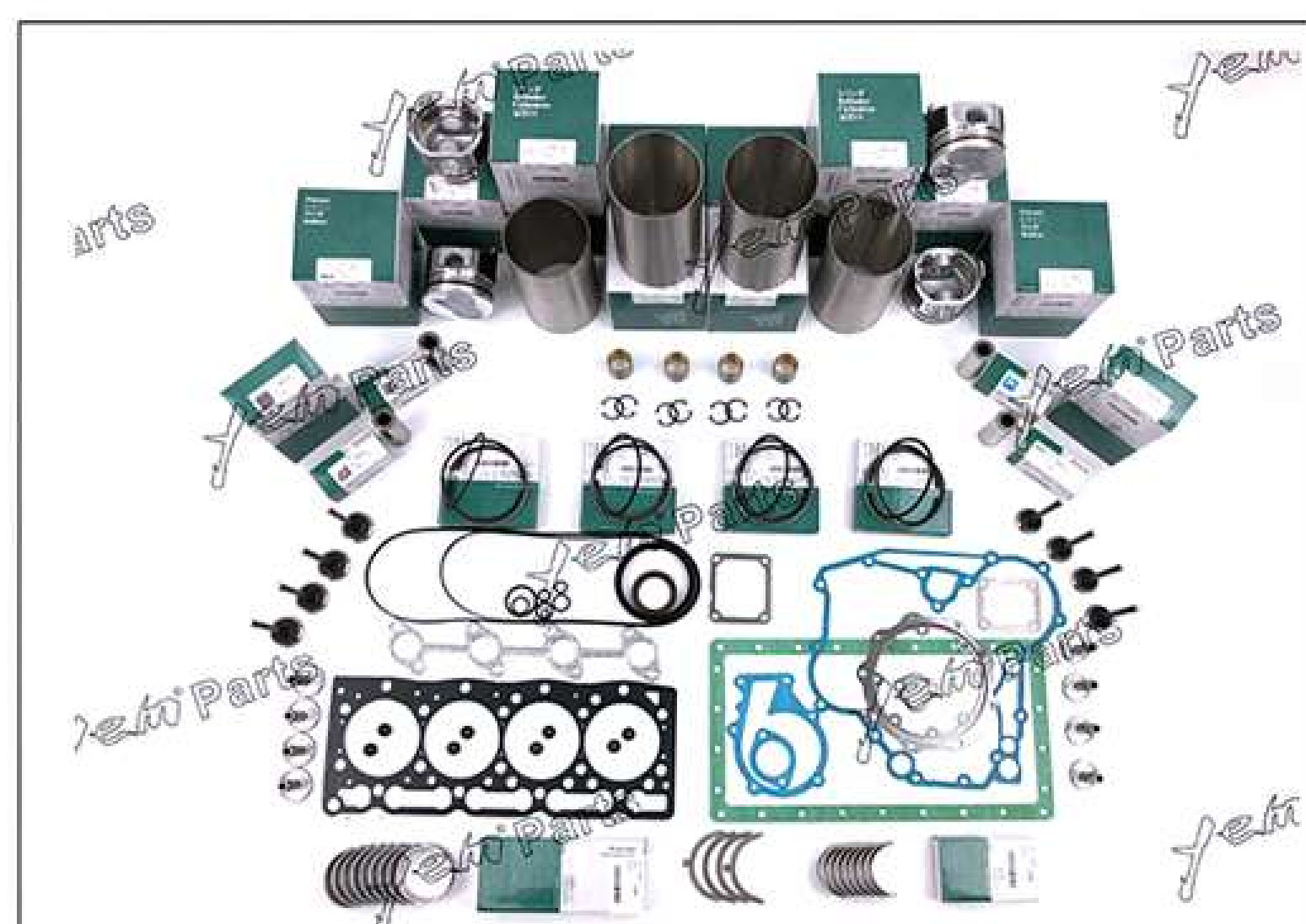

YEM-H8650 DH225-7组件



YEM-H8651 J05E组件

YEM-H8652

适用机型: DH500-7/DH550-7
Application
电压/齿数/功率: 24V/11T/8KW
Specification
零件号: 65-26201-7074A
OE Number
发动机品牌: 斗山大字DOOSAN DEAWOO
Engine Brand

YEM-H8653

适用机型: DH370-7/DH420-7
Application
电压/齿数/功率: 24V/11T/8KW
Specification
零件号: 65-26201-7074
OE Number
发动机品牌: 斗山大字DOOSAN DEAWOO
Engine Brand

YEM-H8654

适用机型: DH225-7
Application
电压/齿数/功率: 24V/11T/4.5KW
Specification
零件号: 29MT款 8200475
OE Number
发动机品牌: 斗山大字DOOSAN DEAWOO
Engine Brand

YEM-H8655

适用机型: 小挖机/山猫
Application
电压/齿数/功率: 12V/11T/2.7KW
Specification
零件号: 6685190
OE Number
发动机品牌: 久保田KUBOTA
Engine Brand

YEM-H8656

适用机型: KX165-5/163-5
Application
电压/齿数/功率: 12V/8T/1.4KW
Specification
零件号: 228000-0250/8691 129129-77010
OE Number
发动机品牌: 久保田KUBOTA
Engine Brand

YEM-H8657

适用机型: DH70/DH80
Application
电压/齿数/功率: 12V/9T/3.5KW
Specification
零件号: M008T50471
OE Number
发动机品牌: 久保田KUBOTA
Engine Brand

YEM-H8658

适用机型: PC56-7
Application
电压/齿数/功率: 12V/9T/2.0KW
Specification
零件号: 028000-9031
OE Number
发动机品牌: 久保田KUBOTA
Engine Brand

YEM-H8659

适用机型: KX183/185
Application
电压/齿数/功率: 12V/9T/4.5KW
Specification
零件号: 428000-4860
OE Number
发动机品牌: 久保田KUBOTA
Engine Brand

YEM-H8660

适用机型: 久保田
Application
电压/齿数/功率: 24V/11T/4.5KW
Specification
零件号: 19872-63013
OE Number
发动机品牌: 久保田KUBOTA
Engine Brand

YEM-H8661

适用机型: CAT307/306
Application
电压/齿数/功率: 24V/11T/3.5KW
Specification
零件号: M8T80471
OE Number
发动机品牌: 卡特CATERPILLAR
Engine Brand

YEM-H8662

适用机型: E305.5/E303
Application
电压/齿数/功率: 12V/13T/2.2KW
Specification
零件号: M8T70471日立款
OE Number
发动机品牌: 卡特CATERPILLAR
Engine Brand

YEM-H8663

适用机型: E313
Application
电压/齿数/功率: 24V/10T/5.0KW
Specification
零件号: 87419387
OE Number
发动机品牌: 卡特CATERPILLAR
Engine Brand

YEM-H8664

适用机型: E320E电喷/E230D2
Application
电压/齿数/功率: 24V/12T/9KW
Specification
零件号: 293-4853
OE Number
发动机品牌: 卡特CATERPILLAR
Engine Brand

YEM-H8665

适用机型: E324/E325/E329
Application
电压/齿数/功率: 24V/12T/7.5KW
Specification
零件号: 39MT减速款/C7
OE Number
发动机品牌: 卡特CATERPILLAR
Engine Brand

YEM-H8666

适用机型: E320E电喷/E320D2
Application
电压/齿数/功率: 24V/12T/9.0KW
Specification
零件号: S03M010183080
OE Number
发动机品牌: 卡特CATERPILLAR
Engine Brand

起动马达 STARTING MOTOR

起动马达 STARTING MOTOR

YEM-H8667



适用机型: E323D2
Application
电压/齿数/功率: 24V/10T/7.5KW
Specification
零件号: 4280007160
OE Number
发动机品牌: 卡特CATERPILLAR
Engine Brand

YEM-H8668



适用机型: 帕金斯/凯斯
Application
电压/齿数/功率: 12V/11T/1.8KW
Specification
零件号: 228000-5120/DRSO511
OE Number
发动机品牌: 卡特CATERPILLAR
Engine Brand

YEM-H8669



适用机型: 山河智能/常林CWS0
Application
电压/齿数/功率: 12V/15T/2.0KW
Specification
零件号: 910237
OE Number
发动机品牌: 康明斯CUMMINS
Engine Brand

YEM-H8682



适用机型: WP10装载机
Application
电压/齿数/功率: 24V/10T/7.5KW
Specification
零件号: 612600090340
OE Number
发动机品牌: 潍柴WEICHA
Engine Brand

YEM-H8683



适用机型: SK460-8/广汽700
Application
电压/齿数/功率: 24V/11T/6KW
Specification
零件号: 28100-2874A
OE Number
发动机品牌: 日野HINO
Engine Brand

YEM-H8684



适用机型: 柳工865H电喷
Application
电压/齿数/功率: 24V/12T/7.5KW
Specification
零件号: 5310735/8200895
OE Number
发动机品牌: 康明斯CUMMINS
Engine Brand

YEM-H8670



适用机型: QSB6.7/R290-9
Application
电压/齿数/功率: 24V/10T/7.5KW
Specification
零件号: 19026032/60615/38MT
OE Number
发动机品牌: 康明斯CUMMINS
Engine Brand

YEM-H8671



适用机型: K19/K38/NT855/E345/349
Application
电压/齿数/功率: 24V/11T/11KW
Specification
零件号: CAT349减速款
OE Number
发动机品牌: 康明斯CUMMINS
Engine Brand

YEM-H8672



适用机型: 雷沃90/福田80
Application
电压/齿数/功率: 12V/11T/3.0KW
Specification
零件号: 5256155/428000-6800
OE Number
发动机品牌: 康明斯CUMMINS
Engine Brand

YEM-H8685



适用机型: 山猫/海斯特叉车
Application
电压/齿数/功率: 12V/10T/2.7KW
Specification
零件号: 1113276/28MT.6573
OE Number
发动机品牌: 康明斯CUMMINS
Engine Brand

YEM-H8686



适用机型: 6D102新款
Application
电压/齿数/功率: 24V/10T/4.8KW
Specification
零件号: 428000-7100
OE Number
发动机品牌: 康明斯CUMMINS
Engine Brand

YEM-H8687



适用机型: EH700/EX220-5
Application
电压/齿数/功率: 24V/11T/5.5KW
Specification
零件号: 28100-1820
OE Number
发动机品牌: 日野HINO
Engine Brand

YEM-H8673



适用机型: YC60-7
Application
电压/齿数/功率: 12V/9T/2.0KW
Specification
零件号: 8-94448-959-1
OE Number
发动机品牌: 康明斯CUMMINS
Engine Brand

YEM-H8674



适用机型: R305/360-7
Application
电压/齿数/功率: 24V/10T/5.5KW
Specification
零件号: 22800-7380
OE Number
发动机品牌: 康明斯CUMMINS
Engine Brand

YEM-H8675



适用机型: R225-7/R220-5
Application
电压/齿数/功率: 24V/10T/5.5KW
Specification
零件号: 128000-2561
OE Number
发动机品牌: 康明斯CUMMINS
Engine Brand

YEM-H8688



适用机型: JS220/230
Application
电压/齿数/功率: 24V/11T/4.0KW
Specification
零件号: IS1106/AZF4267
OE Number
发动机品牌: 杰西博JCB
Engine Brand

YEM-H8689



适用机型: SK350-8
Application
电压/齿数/功率: 24V/11T/5.5KW
Specification
零件号: 28100-2892A日兴款
OE Number
发动机品牌: 神钢KOBELCO
Engine Brand

YEM-H8690



适用机型: EX60-3/5
Application
电压/齿数/功率: 24V/11T/4.0KW
Specification
零件号: S25-158B
OE Number
发动机品牌: 尼桑NISSAN
Engine Brand

YEM-H8676



适用机型: SK450/SK480-6
Application
电压/齿数/功率: 24V/11T/5.5KW
Specification
零件号: M9T60171
OE Number
发动机品牌: 三菱MITSUBISHI
Engine Brand

YEM-H8677



适用机型: HD1250/T850
Application
电压/齿数/功率: 24V/13T/5.5KW
Specification
零件号: M3T95082
OE Number
发动机品牌: 三菱MITSUBISHI
Engine Brand

YEM-H8678



适用机型: HD512/513
Application
电压/齿数/功率: 24V/13T/5.5KW
Specification
零件号: M8T60271
OE Number
发动机品牌: 三菱MITSUBISHI
Engine Brand

YEM-H8691



适用机型: D50/D6推土机
Application
电压/齿数/功率: 24V/11T/5.5KW
Specification
零件号: 600-813
OE Number
发动机品牌: 小松KOMATSU
Engine Brand

YEM-H8692



适用机型: PC450-8/PC490
Application
电压/齿数/功率: 24V/12T/7.5KW
Specification
零件号: 600-813-4930
OE Number
发动机品牌: 小松KOMATSU
Engine Brand

YEM-H8693



适用机型: PC500
Application
电压/齿数/功率: 24V/12T/11KW
Specification
零件号: 600-613-4311/0-28000-7671
OE Number
发动机品牌: 小松KOMATSU
Engine Brand

YEM-H8679



适用机型: SY285
Application
电压/齿数/功率: 24V/11T/8.0KW
Specification
零件号: M009T80771
OE Number
发动机品牌: 三菱MITSUBISHI
Engine Brand

YEM-H8680



适用机型: 加藤HD250
Application
电压/齿数/功率: 24V/11T/3.2KW
Specification
零件号: M2T56471
OE Number
发动机品牌: 三菱MITSUBISHI
Engine Brand

YEM-H8681



适用机型: DCO9/DX380-9/重卡
Application
电压/齿数/功率: 24V/12T/5.5KW
Specification
零件号: 0001261001/0001241001
OE Number
发动机品牌: 潍柴WEICHA
Engine Brand

YEM-H8694



适用机型: SK60-3
Application
电压/齿数/功率: 24V/9T/3.0KW
Specification
零件号: 8944234520
OE Number
发动机品牌: 五十铃ISUZU
Engine Brand

YEM-H8695



适用机型: ZAX70/SY90
Application
电压/齿数/功率: 24V/11T/3.5KW
Specification
零件号: M008T80371
OE Number
发动机品牌: 五十铃ISUZU
Engine Brand

YEM-H8696



适用机型: SH130-5/CS130B
Application
电压/齿数/功率: 24V/11T/3.2KW
Specification
零件号: S25-514C/8980450273
OE Number
发动机品牌: 五十铃ISUZU
Engine Brand

起动机 STARTING MOTOR

发电机 ALTERNATOR

YEM-H8697



适用机型: ZAX230/240
Application
电压/齿数/功率: 24V/13T/5.5KW
Specification
零件号: 8980540630
OE Number
发动机品牌: 五十铃ISUZU
Engine Brand

YEM-H8698



适用机型: ZAX200/210-5
Application
电压/齿数/功率: 24V/11T/4.5KW
Specification
零件号: 028000-6200
OE Number
发动机品牌: 五十铃ISUZU
Engine Brand

YEM-H8699



适用机型: ZAX330/330-5/360-5
Application
电压/齿数/功率: 24V/11T/5.5KW
Specification
零件号: 8980608540
OE Number
发动机品牌: 五十铃ISUZU
Engine Brand

YEM-H8700



适用机型: ZAX470/6WA1
Application
电压/齿数/功率: 24V/11T/7.5KW
Specification
零件号: M009T80971
OE Number
发动机品牌: 五十铃ISUZU
Engine Brand

YEM-H8701



适用机型: CS360/SH460
Application
电压/齿数/功率: 24V/11T/5.5KW
Specification
零件号: M9T62371/M9T61871
OE Number
发动机品牌: 五十铃ISUZU
Engine Brand

YEM-H8702



适用机型: LB924/934
Application
电压/齿数/功率: 24V/11T/6.6KW
Specification
零件号: 0001417024
OE Number
发动机品牌: 利勃海尔LIEBHERR
Engine Brand

YEM-H8703



适用机型: PC30/PC35
Application
电压/齿数/功率: 12V/11T/1.6KW
Specification
零件号: S114-815
OE Number
发动机品牌: 洋马YANMAR
Engine Brand

YEM-H8704



适用机型: PC220-8/200-8
Application
电压/齿数/功率: 24V/10T/55KW
Specification
零件号: 128000-2561
OE Number
发动机品牌: 小松KOMATSU
Engine Brand

YEM-H8705



适用机型: SY195-10/SY225-10
Application
电压/齿数/功率: 24V/11T/5.0KW
Specification
零件号: M008T62371
OE Number
发动机品牌: 三菱MITSUBISHI
Engine Brand

YEM-H8706



适用机型: JCB60/JSSRF103/CLC375B
Application
电压/齿数/功率: 12V/9T/2.0KW
Specification
零件号: F042002150617
OE Number
发动机品牌: 帕金斯PERKINS
Engine Brand

YEM-H8707



适用机型: DX120
Application
电压/齿数/功率: 24V/11T/5.0KW
Specification
零件号: 300516-00040A/36100-52000
OE Number
发动机品牌: 斗山大宇DOOSAN DEAWOO
Engine Brand

YEM-H8708



适用机型: 三一SY485/6WG1/6RB1/6QA1
Application
电压/齿数/功率: 24V/11T/9.0KW
Specification
零件号: M009T82071
OE Number
发动机品牌: 三一SANY
Engine Brand

YEM-H8709



适用机型: S14-102大洋马
Application
电压/齿数/功率: 12V/9T/4.5KW
Specification
零件号: 129940-77010
OE Number
发动机品牌: 洋马YANMAR
Engine Brand

YEM-H8710



C2.2

YEM-H8711



E320GC E330GC

YEM-H8712



适用机型: PC500/600
Application
电压/功率/槽型: 24V/75A/1V
Specification
零件号: 600-821-9551
OE Number
发动机品牌: 小松KOMATSU
Engine Brand

YEM-H8713



适用机型: PC200-8/220-8
Application
电压/功率/槽型: 24V/60A/S84-39
Specification
零件号: 101211-7960
OE Number
发动机品牌: 小松KOMATSU
Engine Brand

YEM-H8714



适用机型: 小松PC70-8/PC75/PC78-8
Application
电压/功率/槽型: 24V/35A/1V
Specification
零件号: 101211-2850
OE Number
发动机品牌: 小松KOMATSU
Engine Brand

YEM-H8715



适用机型: PC600-7/6D140E-3/PC1250
Application
电压/功率/槽型: 24V/90A/1V-2V-8PK
Specification
零件号: 600-825-9130
OE Number
发动机品牌: 小松KOMATSU
Engine Brand

YEM-H8716



适用机型: E320D2
Application
电压/功率/槽型: 24V/115A/12PK
Specification
零件号: 0124655076
OE Number
发动机品牌: 卡特CATERPILLAR
Engine Brand

YEM-H8717



适用机型: CAT330B/336D
Application
电压/功率/槽型: 24V/95A/8PK
Specification
零件号: 101211-8130
OE Number
发动机品牌: 卡特CATERPILLAR
Engine Brand

YEM-H8718



适用机型: E312D/E315D
Application
电压/功率/槽型: 24V/55A/8PK
Specification
零件号: 63377465
OE Number
发动机品牌: 卡特CATERPILLAR
Engine Brand

YEM-H8719



适用机型: E312D/E315D
Application
电压/功率/槽型: 24V/55A/8PK
Specification
零件号: 3436803800
OE Number
发动机品牌: 卡特CATERPILLAR
Engine Brand

YEM-H8720



适用机型: CAT307
Application
电压/功率/槽型: 24V/40A/2V
Specification
零件号: ME202972
OE Number
发动机品牌: 卡特CATERPILLAR
Engine Brand

YEM-H8721



适用机型: E303V/3890
Application
电压/功率/槽型: 12V/45A/单轮
Specification
零件号: 卡特E303.5
OE Number
发动机品牌: 卡特CATERPILLAR
Engine Brand

YEM-H8722



适用机型: LG220/4BT3.9/柳工/徐工
Application
电压/功率/槽型: 24V/45A/8PK
Specification
零件号: 3972731
OE Number
发动机品牌: 康明斯CUMMINS
Engine Brand

YEM-H8723



适用机型: M11/MT855
Application
电压/功率/槽型: 24V/70A/8PK
Specification
零件号: 1901011/1117944
OE Number
发动机品牌: 康明斯CUMMINS
Engine Brand

YEM-H8724



适用机型: LG925/R225-7/柳工/徐工
Application
电压/功率/槽型: 24V/70A/8PK
Specification
零件号: 8600017
OE Number
发动机品牌: 康明斯CUMMINS
Engine Brand

YEM-H8725



适用机型: CLG225D/柳工
Application
电压/功率/槽型: 24V/60A/8PK
Specification
零件号: 0120488206
OE Number
发动机品牌: 康明斯CUMMINS
Engine Brand

YEM-H8726



适用机型: K19/K38
Application
电压/功率/槽型: 24V/100A
Specification
零件号: 3400698/CAL0611
OE Number
发动机品牌: 康明斯CUMMINS
Engine Brand

YEM-H8727



适用机型: R220-5/LG908/现代/柳工
Application
电压/功率/槽型: 24V/50A/74-46
Specification
零件号: 600-825-6110
OE Number
发动机品牌: 康明斯CUMMINS
Engine Brand

YEM-H8728



适用机型: YC60-7/YC85-7/玉柴
Application
电压/功率/槽型: 12V/45A/1V
Specification
零件号: 101211-3730
OE Number
发动机品牌: 康明斯CUMMINS
Engine Brand

YEM-H8729



适用机型: CAT345/349D
Application
电压/功率/槽型: 24V/95A/8PK
Specification
零件号: 101211-8400
OE Number
发动机品牌: 康明斯CUMMINS
Engine Brand

YEM-H8730



适用机型: R210-5/柳工/徐工
Application
电压/功率/槽型: 24V/60A/8PK
Specification
零件号: 37N-01010/C4938600
OE Number
发动机品牌: 康明斯CUMMINS
Engine Brand

YEM-H8731



适用机型: 现代R215
Application
电压/功率/槽型: 24V/90A/8PK
Specification
零件号: 2108-42000
OE Number
发动机品牌: 康明斯CUMMINS
Engine Brand

发电机 ALTERNATOR

水泵 WATER PUMP























<p>YEM-H8732</p>  <p>适用机型: 现代R455-7/R505 Application 电压/功率/槽型: 24V/80A/8PK Specification 零件号: 37300-48000 OE Number 发动机品牌: 康明斯CUMMINS Engine Brand</p>	<p>YEM-H8733</p>  <p>适用机型: R60-9/DH60-9 Application 电压/功率/槽型: 12V/80A/1V Specification 零件号: LR180-760 OE Number 发动机品牌: 洋马YAMMAR Engine Brand</p>	<p>YEM-H8734</p>  <p>适用机型: 现代挖掘机 R60-9 Application 电压/功率/槽型: 12V/100A/1V Specification 零件号: 21M9-44001 OE Number 发动机品牌: 洋马YAMMAR Engine Brand</p>	<p>YEM-H8735</p>  <p>适用机型: R60-7 Application 电压/功率/槽型: 12V/45A/A69-23 Specification 零件号: 101211-2951 OE Number 发动机品牌: 洋马YAMMAR Engine Brand</p>
<p>YEM-H8736</p>  <p>适用机型: DH220-3/280-3/斗山 Application 电压/功率/槽型: 24V/60A/2B75-42 Specification 零件号: PK39005 OE Number 发动机品牌: 斗山大宇 DOOSAN DEAWOOD Engine Brand</p>	<p>YEM-H8737</p>  <p>适用机型: DX300/370/550/斗山 Application 电压/功率/槽型: 24V/60A/8PK Specification 零件号: 0-35000-4190 OE Number 发动机品牌: 斗山大宇 DOOSAN DEAWOOD Engine Brand</p>	<p>YEM-H8738</p>  <p>适用机型: DH70 Application 电压/功率/槽型: 12V/90A/1V Specification 零件号: 6678205 OE Number 发动机品牌: 斗山大宇 DOOSAN DEAWOOD Engine Brand</p>	<p>YEM-H8739</p>  <p>适用机型: DH80 Application 电压/功率/槽型: 12V/85A/1V Specification 零件号: 96224431/2046100 OE Number 发动机品牌: 斗山大宇 DOOSAN DEAWOOD Engine Brand</p>
<p>YEM-H8740</p>  <p>适用机型: V3307/V3800 Application 电压/功率/槽型: 12V/60A/1V Specification 零件号: A1TA3677B OE Number 发动机品牌: 久保田KUBOTA Engine Brand</p>	<p>YEM-H8741</p>  <p>适用机型: D1703/PC56-7 Application 电压/功率/槽型: 12V/35A/A63-20 Specification 零件号: 101211-2951 OE Number 发动机品牌: 久保田KUBOTA Engine Brand</p>	<p>YEM-H8742</p>  <p>适用机型: JCB220/230/JCB Application 电压/功率/槽型: 24V/70A/8PK Specification 零件号: DRA114127/32008611 OE Number 发动机品牌: 道依茨DEUTZ Engine Brand</p>	<p>YEM-H8743</p>  <p>适用机型: KHD临工挖机 Application 电压/功率/槽型: 24V/55A/1V Specification 零件号: 11203396 OE Number 发动机品牌: 道依茨DEUTZ Engine Brand</p>
<p>YEM-H8744</p>  <p>适用机型: SK450-8单管 Application 电压/功率/槽型: 24V/55A/2V Specification 零件号: A4TU3586 OE Number 发动机品牌: 三菱MITSUBISHI Engine Brand</p>	<p>YEM-H8745</p>  <p>适用机型: R210-5/7 Application 电压/功率/槽型: 24V/70A/2C98-55 Specification 零件号: LR150-714 OE Number 发动机品牌: 三菱MITSUBISHI Engine Brand</p>	<p>YEM-H8746</p>  <p>适用机型: DX380-9/390-9C电喷/斗山 Application 电压/功率/槽型: 24V/110A/10PK Specification 零件号: 2035629 OE Number 发动机品牌: 斯堪尼亚SCANIA Engine Brand</p>	<p>YEM-H8747</p>  <p>适用机型: EC140角位156长/临工 Application 电压/功率/槽型: 24V/55A/10PK Specification 零件号: 01183183 OE Number 发动机品牌: 临工LINCONG Engine Brand</p>
<p>YEM-H8748</p>  <p>适用机型: EC60 Application 电压/功率/槽型: 12C/80A/1V Specification 零件号: 14653971/2006491 OE Number 发动机品牌: 沃尔沃VOLVO Engine Brand</p>	<p>YEM-H8749</p>  <p>适用机型: EC210/EC240 Application 电压/功率/槽型: 24V/80A/1V Specification 零件号: CA1853IR OE Number 发动机品牌: 沃尔沃VOLVO Engine Brand</p>	<p>YEM-H8750</p>  <p>适用机型: ZAX330/日立/扎克 Application 电压/功率/槽型: 24V/50A/3B82-65 Specification 零件号: A4TU5485 OE Number 发动机品牌: 五十铃ISUZU Engine Brand</p>	<p>YEM-H8751</p>  <p>适用机型: EX70G/JG1 Application 电压/功率/槽型: 24V/60A/1V Specification 零件号: 129E20-77200 OE Number 发动机品牌: 五十铃ISUZU Engine Brand</p>



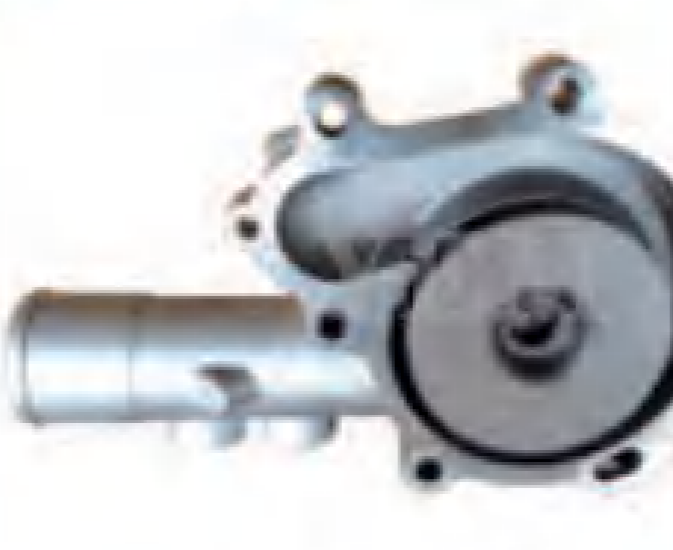













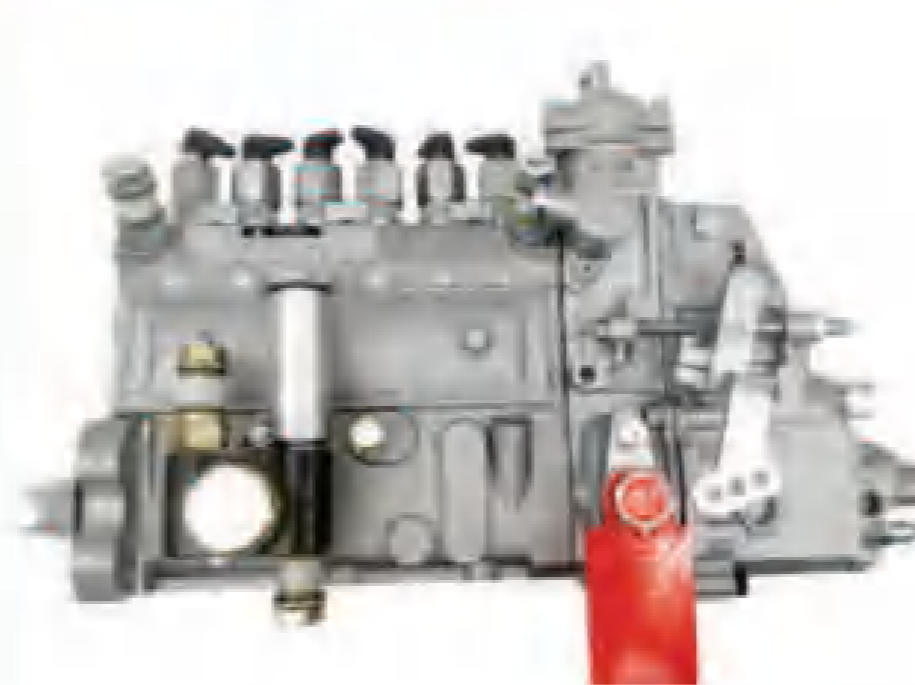

<p>YEM-H8752</p>  <p>21010-44G25 N-59/TD25</p>	<p>YEM-H8753</p>  <p>21010-40K25 N-67/TD27</p>	<p>YEM-H8754</p>  <p>8941769890 KI-35A/4BA1</p>	<p>YEM-H8755</p>  <p>8944939850 KI-42A/4HF1</p>
<p>YEM-H8756</p>  <p>16110-78156-71 KT-111A/4Y-7F</p>	<p>YEM-H8757</p>  <p>32C45-00022 KM-89A/S4Q2</p>	<p>YEM-H8758</p>  <p>16100-69325 KT-99A/1FZ</p>	<p>YEM-H8759</p>  <p>U5WM0175</p>
<p>YEM-H8760</p>  <p>32A45-00022 KM-88A/S4S</p>	<p>YEM-H8761</p>  <p>21010-03J25 KN-45A/TB-42</p>	<p>YEM-H8762</p>  <p>MD974649 KM-17A/4G15</p>	<p>YEM-H8763</p>  <p>8943768620 KI-43A/C240</p>
<p>YEM-H8764</p>  <p>490B-42000 490</p>	<p>YEM-H8765</p>  <p>101302937440 02937603</p>	<p>YEM-H8766</p>  <p>8AK1-15-010 KMZ-32/F2</p>	<p>YEM-H8767</p>  <p>2101050K26 KN-05/H50-2</p>
<p>YEM-H8768</p>  <p>16100-00705 KT-114A/2J</p>	<p>YEM-H8769</p>  <p>16100-22060 KT-115A/2J</p>	<p>YEM-H8770</p>  <p>5136102020 4FE1</p>	<p>YEM-H8771</p>  <p>AD46651192 3AF1</p>
<p>YEM-H8772</p>  <p>16120-96120 KT-105</p>	<p>YEM-H8773</p>  <p>161207815171 KT-132A/6F4Y</p>	<p>YEM-H8774</p>  <p>FE79-15-010 KMZ-29A/FE</p>	<p>YEM-H8775</p>  <p>21010-L1100 KN-30A/H20</p>

水泵 WATER PUMP

<p>YEM-H8776</p>  <p>16100-79035/6 KT-54A/491</p>	<p>YEM-H8777</p>  <p>34445-10014 S6E</p>	<p>YEM-H8778</p>  <p>32B45-10031 KM-99A/S6S</p>	<p>YEM-H8779</p>  <p>16120-78201-71 T-144</p>
<p>YEM-H8780</p>  <p>16110-78206-71 7F1DZ</p>	<p>YEM-H8781</p>  <p>16100-78154-71 4Y-5F</p>	<p>YEM-H8782</p>  <p>U5WM0173</p>	<p>YEM-H8783</p>  <p>16110-78206-71 7F1DZ</p>
<p>YEM-H8784</p>  <p>16110-78205-71 8F1DZ</p>	<p>YEM-H8785</p>  <p>16100-78156-71 7F-4Y</p>	<p>YEM-H8786</p>  <p>6202631200 KKO-01/4D95</p>	<p>YEM-H8787</p>  <p>8970285900 KI-64A/4JG2</p>
<p>YEM-H8788</p>  <p>16100-72800 KT-116/1DZ</p>	<p>YEM-H8789</p>  <p>16100-78300-71 KT-104A/1Z</p>	<p>YEM-H8790</p>  <p>16100-78701-71 2Z</p>	<p>YEM-H8791</p>  <p>21010-FU425 K21</p>
<p>YEM-H8792</p>  <p>16120-78005-71 4P(GAO)</p>	<p>YEM-H8793</p>  <p>16120-78007-71 4P(KT-109A)</p>	<p>YEM-H8794</p>  <p>16110-78121-71 16120-78121-71 5K SMALL PULLEY(小的皮带轮) 4P</p>	<p>YEM-H8795</p>  <p>34345-00013 MITSUBISHI五十铃 S4E</p>
<p>YEM-H8796</p>  <p>MM433-17001 L3E</p>	<p>YEM-H8797</p>  <p>32A45-10031 S4S OLD</p>	<p>YEM-H8798</p>  <p>SE02-15-100 XA HA 8K</p>	<p>YEM-H8799</p>  <p>16120-96601-71 5R</p>

水泵 WATER PUMP

<p>YEM-H8800</p>  <p>5136100381 KI-17A/G201</p>	<p>YEM-H8801</p>  <p>ME972457 KM-74A/4G63</p>	<p>YEM-H8802</p> 	<p>YEM-H8803</p>  <p>8F2Z</p>
<p>YEM-H8804</p>  <p>KT-09A/4P 16120-78007-71</p>	<p>YEM-H8805</p>  <p>S4L MM433424</p>	<p>YEM-H8806</p>  <p>A2300 4900902</p>	<p>YEM-H8807</p>  <p>6BG1叉车专用 1-13610-876-0</p>
<p>YEM-H8808</p>  <p>AD46651192/1239350-42010 3TNA72</p>	<p>YEM-H8809</p>  <p>6132-61-1616 4D94E</p>	<p>YEM-H8810</p>  <p>11952042000 2TNE68</p>	<p>YEM-H8811</p>  <p>129002-42004 4TNE88</p>
<p>YEM-H8812</p>  <p>129917-42010 4TNE92</p>	<p>YEM-H8813</p>  <p>129470-42003 4TNE98</p>	<p>YEM-H8814</p>  <p>119810-42002 3D82</p>	<p>YEM-H8815</p>  <p>119660-42004 YANMAR486</p>
<p>YEM-H8816</p>  <p>123900-42000 4TNV106</p>	<p>YEM-H8817</p>  <p>123900-42000 4TNV106 WITHOUT TUBE</p>	<p>YEM-H8818</p>  <p>119540-42000 3TNA70 2TNV70 3TNV76</p>	<p>YEM-H8819</p>  <p>119624-42001 3TNE74</p>
<p>YEM-H8820</p>  <p>119233-42000 3TNE68-TS</p>	<p>YEM-H8821</p>  <p>13-509 4TNV86/4TN86</p>	<p>YEM-H8822</p>  <p>119802-42002 3DNV82A/3D8E-5</p>	<p>YEM-H8823</p>  <p>119266-420102/119266-42101 /11966-42100 3TN68/3TNE68</p>

<p>YEM-H8824</p>  <p>PC350-8 6D114 C8.3 3973228 共轨柴油泵总成</p>	<p>YEM-H8825</p>  <p>共轨柴油泵总成 SK130-8</p>	<p>YEM-H8826</p>  <p>共轨柴油泵总成 三一245 D06FR</p>	<p>YEM-H8827</p>  <p>094000-0421 22100-E0301</p>
<p>YEM-H8828</p>  <p>094000-0633 6219-71-1121</p>	<p>YEM-H8829</p>  <p>094000-0625 6219-71-1111</p>	<p>YEM-H8830</p>  <p>094000-0574 6251-71-1120</p>	<p>YEM-H8831</p>  <p>094000-0530 22100-E0361</p>
<p>YEM-H8832</p>  <p>094000-0673 115606-5153</p>	<p>YEM-H8833</p>  <p>094000-0810 8-98192478-0</p>	<p>YEM-H8834</p>  <p>094000-0450 6217-71-1131</p>	<p>YEM-H8835</p>  <p>6D102柴油泵</p>
<p>YEM-H8836</p>  <p>共轨柴油泵总成 6D102</p>	<p>YEM-H8837</p>  <p>共轨柴油泵总成 6BG1</p>	<p>YEM-H8838</p>  <p>6BG1柴油泵</p>	<p>YEM-H8839</p>  <p>6HK1直喷 106671-6452</p>
<p>YEM-H8840</p>  <p>6WG1柴油泵</p>	<p>YEM-H8841</p>  <p>E 3412EC27 C38 10R-1001 235-2026 225-0567</p>	<p>YEM-H8842</p>  <p>322C泵总成 186-3410</p>	<p>YEM-H8843</p>  <p>3412E泵总成 235-2026 10R-1001</p>

<p>YEM-H8844</p>  <p>E C9 C-9 254-4358 319-0678 10R-8900 10R-8898</p>	<p>YEM-H8845</p>  <p>C7泵总成 319-0677 10R-8899 11R-1613</p>	<p>YEM-H8846</p>  <p>C9泵总成 319-0678 10R-8900</p>	<p>YEM-H8847</p>  <p>320D泵总成 326-4635 10R-7662</p>	<p>YEM-H8848</p>  <p>C7泵总成 476-8766 20R-1635</p>
<p>YEM-H8849</p>  <p>C7泵总成 476-8769 20R-1636</p>	<p>YEM-H8850</p>  <p>E13C 094000-0740</p>	<p>YEM-H8851</p>  <p>JCB 320 06620高压油泵</p>	<p>YEM-H8852</p>  <p>PC70-8 4D95</p>	<p>YEM-H8853</p>  <p>PC300-8 6D114柴油泵</p>
<p>YEM-H8854</p>  <p>V3800-294000-1820</p>	<p>YEM-H8855</p>  <p>JCB 320 06825高压油泵</p>	<p>YEM-H8856</p>  <p>3D88泵头X4-3</p>	<p>YEM-H8857</p>  <p>4TNV88泵头X4</p>	<p>YEM-H8858</p>  <p>4TNV94 洋马X5泵头</p>
<p>YEM-H8859</p>  <p>洋马X9泵头</p>	<p>YEM-H8860</p>  <p>V3300 V3800泵头</p>	<p>YEM-H8861</p>  <p>E320D</p>	<p>YEM-H8862</p>  <p>泵头总成 320D</p>	<p>YEM-H8863</p>  <p>729975-51310</p>
<p>YEM-H8864</p>  <p>CAT C7 C9</p>	<p>YEM-H8865</p>  <p>J08联轴器</p>	<p>YEM-H8866</p>  <p>J08联轴器1</p>	<p>YEM-H8867</p>  <p>J08E联轴器联结块</p>	<p>YEM-H8868</p>  <p>J08E联轴器法兰</p>

喷油嘴 INJECTOR ASSY

喷油嘴 INJECTOR ASSY

YEM-H8869



C7喷油器总成
387-9427 10R-7225 20R-8066

YEM-H8870



C9喷油器总成
387-9432 10R-7223 20R-8065

YEM-H8871



3508B喷油器总成 392-0206 20R-1270

YEM-H8884



E C7.1 FUEL INJECTOR
0445120347 20R-4560 391-3974

YEM-H8885



E C7.1 FUELINJECTOR
0445120371 20R-4561 396-9626

YEM-H8886



0445120305

YEM-H8872



C9.3喷油器 456-3589 20R-5073

YEM-H8873



C7喷油器总成 557-7627 20R-9079

YEM-H8874



EPU单体泵 BEBU5A00000
1625753 1668325 2135456

YEM-H8887



E C4.4/E C7.1
370-7282 29500-0401 20R-2478

YEM-H8888



3412E FUELINJECTOR ASSY
174-7526 20R-0758

YEM-H8889



E3176C FUELINJECTOR ASSY
317-5278 20R-0055

YEM-H8875



EPU单体泵 BEBU4B00200 1861200

YEM-H8876



共轨喷油器 1933612 2031835

YEM-H8877



共轨柴油喷油器 2047601

YEM-H8890



C12 C-12 喷油器总成166-0149

YEM-H8891



E C4.2 FUEL INJECTOR
326-4756 10R-7951 32F61-00014

YEM-H8892



C-9喷油器总成
10R-7224 236-0962

YEM-H8878



C
2867147 2867147NX FOOBJ00001
FOOBJ00000 0986435900

YEM-H8879



M11喷油器
4061851 4061851D 4061851PX
4061851RX 4061851RXN 4061851UX

YEM-H8880



E3.18喷油器
BEBE4D24001 BEBE4D08001 BEBE4D16001
7421340611 9021371672 21371672 21340611
85003263 3801618

YEM-H8893



C-9喷油器总成 172-5780

YEM-H8894



3512B喷油器总成
20R-1272 392-0208 386-1760

YEM-H8895



C-10喷油器总成 212-3462 10R-0967

YEM-H8881



QSK23喷油器
4088431 4088431D 4088431NX
4088431PX 4088431-RX

YEM-H8882



QSK60喷油器
4326781 4326781NX 4326781XN
4326781UX 4326781-RX

YEM-H8883



N14喷油器 4384360

YEM-H8896



C11喷油器总成 249-0712 10R-3147

YEM-H8897



C13喷油器总成 249-0713 10R-3262

YEM-H8898



C15喷油器总成 253-0616 10R-3265

喷油嘴 INJECTOR ASSY

喷油嘴 INJECTOR ASSY

YEM-H8899



QSK19喷油器总成
4964170 4955524 4955527
FOOBLOJ020

YEM-H8900



F2喷油器 BEBJ1F12101 22378580

YEM-H8901



共轨单体泵
0414693001 0414693006 0986437601
7421005584 04900939 04290102

YEM-H8914



喷油咀 6WG1T ZAX470-3
8-97603415-2

YEM-H8915



喷油咀PC400/450-7
A6D125E 095000-1211

YEM-H8916



喷油咀 PC450-8 6D125
095000-6070

YEM-H8917



喷油咀
SK140-8 SK135-8
D04FR 0445 012 126

YEM-H8902



共轨单体泵
0414693006 0414693001 0986437601
7421005584 04900939 04290102

YEM-H8903



共轨单体泵
0414693007 02113695 2113695

YEM-H8904



博世单体泵
0414799005 0414799025 0986445102

YEM-H8918



卡特 9L6969

YEM-H8919



4W7019

YEM-H8920



3306 8N7005 8N7006

YEM-H8921



OEM:3054220

YEM-H8905



博世单体泵
0414799008 0414799027 0986445103
F00E200403 0280746902 A0280746902

YEM-H8906



博世单体泵
0414799025 0414799005 0986445102

YEM-H8907



A3喷油器
SE501957 BEBE4B17102 BEBE4B17002
EX631012 RE517659 RE517662
RG33967 SE501957

YEM-H8922



CAT 105118-5300

YEM-H8923



PC200-7 6D102
0432131717 KDAL59P16

YEM-H8924



PC200-6
3207-11-3100 SA6D952

YEM-H8925



PC300-7 6D114
0432191342

YEM-H8908



E1喷油器
BEBE4C01101 BEBE4C01001
20440388 85000071 3803654

YEM-H8909



C27喷油器总成 374-0751 20R-2285

YEM-H8910



C15喷油器总成 10R-3265 253-0616

YEM-H8926



道依茨 0414401105

YEM-H8927



道依茨 0414401106

YEM-H8928



大宇 DOOSAN
DX300 0445120140

YEM-H8929



大宇 DOOSAN 0445120145

YEM-H8911



JCB

YEM-H8912



4M50喷油器总成
E3512 4P-9075 0R-3051

YEM-H8913



3126B/3126E
177-4752 177-4754 178-0199
10R-9237 222-5965

YEM-H8930



SM095000-57606K

YEM-H8931



4M50喷油器总成

YEM-H8932



3512A 4P9076 7E6048
6L4355 9Y3773
7C4148 6L4357



















YEM-H8933























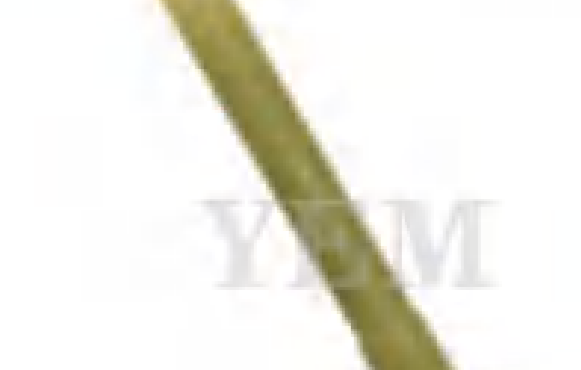





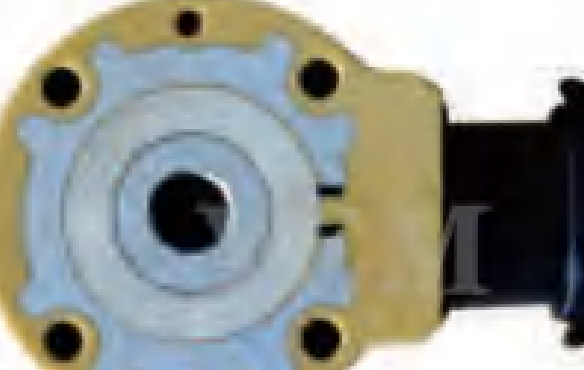

JHON DEERE 7430 INJECROR
095000-6490 RE529118
RE524392

喷油嘴 INJECTOR ASSY

机油喷嘴 OIL NOZZLE
泄压阀 PRESSURE RELIEF VALVE

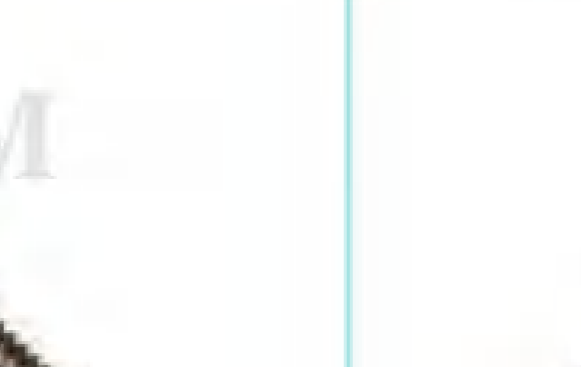
<p>YEM-H8934</p>  <p>3204 4W-7015 0R-3419</p>	<p>YEM-H8935</p>  <p>E 3406B 3406C 3408 3408B 3408C HT400 4W-7017 0R-3421 0R-1744</p>	<p>YEM-H8936</p>  <p>3406B 3406C 3408 3408B 3408C 3412 3412C 4W-7018 0R-1745 0R-3422</p>	<p>YEM-H8937</p>  <p>S6K S4K 3064T 3066T 51-7706</p>
<p>YEM-H8938</p>  <p>E 3208 3204 7W-3710</p>	<p>YEM-H8939</p>  <p>E 3406B 3406C 3412 3412C 7W-7026 0R-3423 0R-1746</p>	<p>YEM-H8940</p>  <p>E 3406B 3406C 7W-7032 0R-1747 0R-3424</p>	<p>YEM-H8941</p>  <p>E 3306 3306B 7W-7032 0R-4124</p>
<p>YEM-H8942</p>  <p>E 3304 3304BE 3306 3306B 8N-7005 0R-1740 0R-3418</p>	<p>YEM-H8943</p>  <p>3114/3116 127-8216</p>	<p>YEM-H8944</p>  <p>E 3412 3412C 3408B SR500 SR4 130-1804 0R-8787</p>	<p>YEM-H8945</p>  <p>3056 /3054T 147-5513 20R-0326 61-1214 2645A060</p>
<p>YEM-H8946</p>  <p>E3306 3306B 170-5187 0R-4124</p>	<p>YEM-H8947</p>  <p>E C32 3412E 3408E 174-7526 174-7527 198-6877 20R-0758 10R-1267 10R-1266 4CR01974 232-1171 232-1183</p>	<p>YEM-H8948</p>  <p>E320C S6KT 212-8470</p>	
<p>YEM-H8949</p>  <p>3056E/1106C-E60TA 216-9786 2645F027 0432133789</p>	<p>YEM-H8950</p>  <p>E C4.2 326-4740 10R-7676</p>	<p>YEM-H8951</p>  <p>E C71直喷 454-5091 398-1507 LJRB06005A</p>	

<p>YEM-H8952</p>  <p>4HF1</p>	<p>YEM-H8953</p>  <p>4JB1-4JG1</p>	<p>YEM-H8954</p>  <p>4M40</p>	<p>YEM-H8955</p>  <p>4M40链条喷嘴</p>	<p>YEM-H8956</p>  <p>LB934</p>
<p>YEM-H8957</p>  <p>6D14</p>	<p>YEM-H8958</p>  <p>6D16T</p>	<p>YEM-H8959</p>  <p>6D24T</p>	<p>YEM-H8960</p>  <p>H07C</p>	<p>YEM-H8961</p>  <p>6WG1</p>
<p>YEM-H8962</p>  <p>C6.4</p>	<p>YEM-H8963</p>  <p>C9</p>	<p>YEM-H8964</p>  <p>6BT</p>	<p>YEM-H8965</p>  <p>6CT-6D114</p>	<p>YEM-H8966</p>  <p>6D102</p>
<p>YEM-H8967</p>  <p>K19</p>	<p>YEM-H8968</p>  <p>QSC-6D114电喷</p>	<p>YEM-H8969</p>  <p>0281</p>	<p>YEM-H8970</p>  <p>C6.4高压油泵电磁阀 312-5620</p>	<p>YEM-H8971</p>  <p>C7 C9喷嘴电磁阀 254-4339</p>
<p>YEM-H8972</p>  <p>312-5620</p>	<p>YEM-H8973</p>  <p>CAT</p>	<p>YEM-H8974</p>  <p>6D140 95400-0240</p>	<p>YEM-H8975</p>  <p>CAT 416-7101</p>	<p>YEM-H8976</p>  <p>CAT 369-6662</p>
<p>YEM-H8977</p>  <p>CAT 32F61-00062</p>	<p>YEM-H8978</p>  <p>A:090310-0500 B:090310-0490</p>	<p>YEM-H8979</p>  <p>32F61-10050E320D 减压阀</p>	<p>YEM-H8980</p>  <p>4WG200 12V/24V 0260 120 024 0501 313 372</p>	

YEM-H8981

 共轨管 PC200-8 6754-71-1210

YEM-H8983

 共轨管 PC400-7/8

YEM-H8985

 共轨管
 J08E YH23810E0020

YEM-H8987

 共轨管 6HK1

YEM-H8989

 共轨管 VOLVO240D7E 0445226047

YEM-H8991

 共轨管 E320D C6.6 458-3416

YEM-H8993

 共轨管 SK140-8 0445224040

YEM-H8995

 共轨管 JCB 32192040519

YEM-H8982

 高压油泵(共轨管)PC350-8 6D114 C8.3 3963815

YEM-H8984

 共轨管 SK200-8
 J05E VH23810E0060

YEM-H8986

 共轨管 4HK1

YEM-H8988

 共轨管
 ISUZU 6WF1/6WG1/6UZ1

YEM-H8990

 共轨管 VOLVO210 D6E 0445226188

YEM-H8992

 共轨管 EC210D

YEM-H8994

 共轨管 0445224025 3977727

YEM-H8996

 共轨总成 6D125-3 ND095441-0180



YEM-H8997

 FAG 6D102手油泵
 OEM:105220-5960

YEM-H8998

 FAG 6HK1手油泵
 OEM:1-15750130-0

YEM-H8999

 FAG E320C手油泵
 OEM:255-2969

YEM-H9000

 FAG 6BG1手油泵
 OEM:1-15750192-0

YEM-H9001

 FAG DH220-5手油泵
 OEM:105210-1570

YEM-H9002

 FAG S6K手油泵
 OEM:105220-7180

YEM-H9003

 FAG 6BD1手油泵
 OEM:1-15750048-0

YEM-H9004

 FAG DH300-5手油泵
 OEM:105210-1700

YEM-H9005

 01676136 DEUTZ

YEM-H9006





















 VOLVO 04296790
 装载机 120E

























YEM-H9007

 VOLVO 大轮

YEM-H9008

 04503571 C1013C

<p>YEM-H9009</p>  <p>CAT E336D C9 318-6357</p>	<p>YEM-H9010</p>  <p>CAT C6.4 C6.6 293-0249 292-3751</p>	<p>YEM-H9011</p>  <p>CAT 162-9612</p>	<p>YEM-H9012</p>  <p>CAT 149-1950</p>
<p>YEM-H9013</p>  <p>293-0249燃油泵</p>	<p>YEM-H9014</p>  <p>C13 C15 燃油泵 384-8612</p>	<p>YEM-H9015</p>  <p>VOLVO EC480</p>	<p>YEM-H9016</p>  <p>VOVLO480</p>
<p>YEM-H9017</p>  <p>CAT E320D2 E312D2 E320D2 446-5409 24V</p>	<p>YEM-H9018</p>  <p>CAT E320GC 12/24V 446-5408 446-5409</p>	<p>YEM-H9019</p>  <p>ZAX200-5A YA00065646</p>	<p>YEM-H9020</p>  <p>JOHN DEERE 12/24V</p>
<p>YEM-H9021</p>  <p>CAT 12V/24V</p>	<p>YEM-H9022</p>  <p>QST30 4975617 康明斯</p>	<p>YEM-H9023</p>  <p>PC300-8 3968190 6745-71-1820 电子油泵</p>	<p>YEM-H9024</p>  <p>OEM:4943048 12V</p>
<p>YEM-H9025</p>  <p>1106250E52EY/A</p>	<p>YEM-H9026</p>  <p>2447222126 道依茨输油泵 DEUTZ</p>	<p>YEM-H9027</p>  <p>依维柯输油泵 NAVECO</p>	<p>YEM-H9028</p>  <p>DX370 1539298 SCANIA</p>

<p>YEM-H9029</p>  <p>久保田</p>	<p>YEM-H9030</p>  <p>道依茨输油泵 DEUTZ</p>	<p>YEM-H9031</p>  <p>3D84</p>	<p>YEM-H9032</p>  <p>AR053-4-2641A053</p>
<p>YEM-H9033</p>  <p>AR057-2-U LPK0004</p>	<p>YEM-H9034</p>  <p>AR062-4757883</p>	<p>YEM-H9035</p>  <p>AR089-3-1J710-52030</p>	<p>YEM-H9036</p>  <p>AR090-2830266</p>
<p>YEM-H9037</p>  <p>AR092-15261-52030</p>	<p>YEM-H9038</p>  <p>AR182-3-U LPK0002</p>	<p>YEM-H9039</p>  <p>AR183-U LPK0034</p>	<p>YEM-H9040</p>  <p>AR187-U LPK0007</p>
<p>YEM-H9041</p>  <p>AR218-U LPK0036</p>	<p>YEM-H9042</p>  <p>AR314-15451-52033</p>	<p>YEM-H9043</p>  <p>AR315-右16541-52033</p>	<p>YEM-H9044</p>  <p>久保田</p>
<p>YEM-H9045</p>  <p>临工4190001819</p>	<p>YEM-H9046</p>  <p>帕金斯 PERKINS</p>	<p>YEM-H9047</p>  <p>久保田</p>	<p>YEM-H9048</p>  <p>久保田 16285-52032</p>
<p>YEM-H9049</p>  <p>E336D 电子油泵</p>	<p>YEM-H9050</p>  <p>帕金斯 PERKINS</p>	<p>YEM-H9051</p>  <p>SK460-8 PC360-7</p>	<p>YEM-H9052</p>  <p>VOVLO EC480</p>

YEM-H9053



6693-62-9213 NH220

YEM-H9054



7N0677

YEM-H9055



4N6972/2W1008 CAT3412

YEM-H9056



4W4956 35工程车

YEM-H9057



235-9760-01 CAT713

YEM-H9058



4W0413 35工程车

YEM-H9059



4W6047/7C0145 CAT3406

YEM-H9060



4W0418 35工程车

YEM-H9061



C15 133-0125/4W6043/223-7962 CAT

YEM-H9062



7N0101/5S0264/5S3292

YEM-H9063



C13 359-1636 CAT

YEM-H9064



135-55771136-6094

YEM-H9065



NT855新款

YEM-H9066



CAT/PERKINS

YEM-H9067



7N0128/9M8818

YEM-H9068



4W7190/4W7188

YEM-H9069



2W9979/2W9978

YEM-H9070

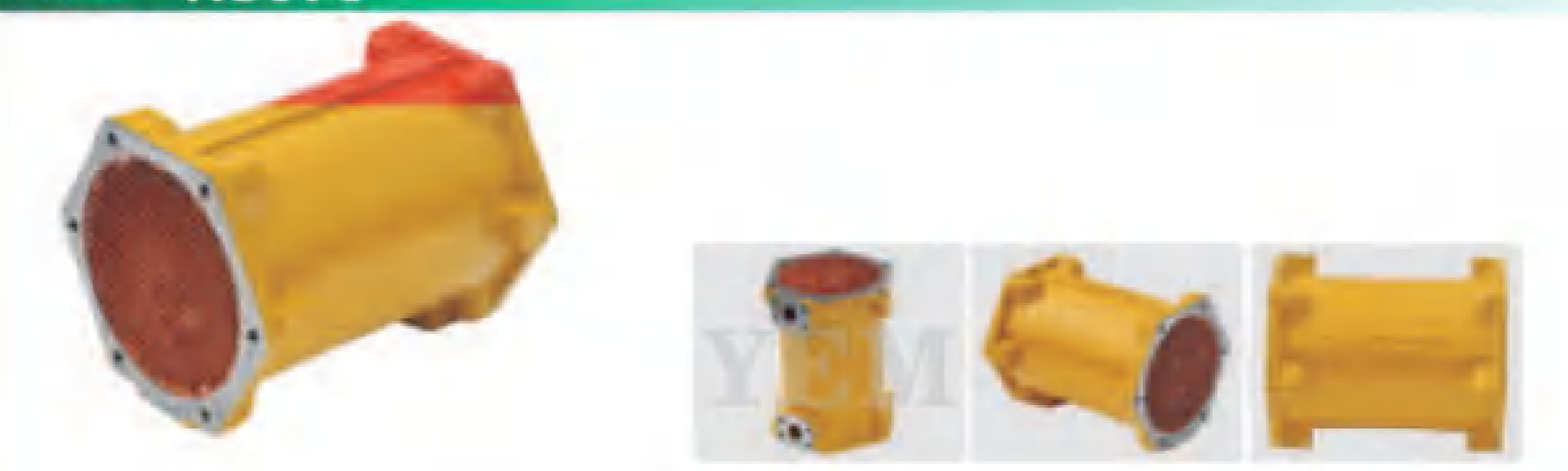

7N3505/7N3521M

YEM-H9071



NT855新款

YEM-H9072



2P8797/7N0110 3306

YEM-H9073



C13 114-4514 CAT

YEM-H9074



145-9282

YEM-H9075



4W0416 35工程车

YEM-H9076

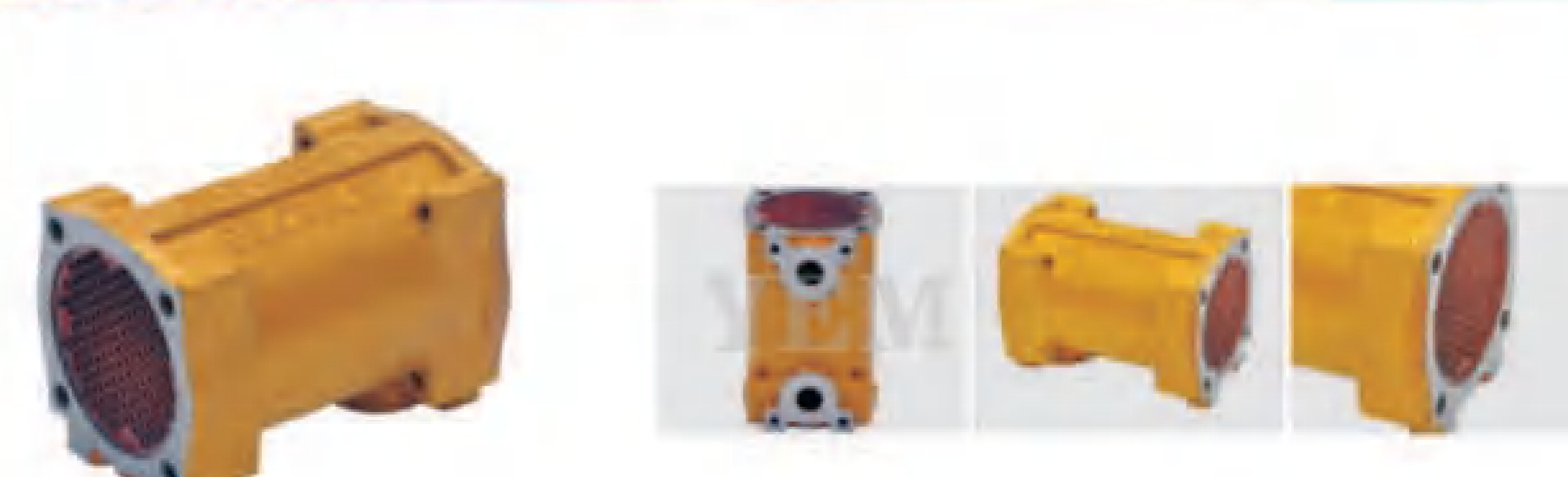

7N0165/7S6394 3306

散热器总成 OIL COOLER ASSY

机油散热器边盖 OIL COOLER COVER

YEM-H9077



4D31

YEM-H9078



NT855新款

YEM-H9079



NT855 218754

YEM-H9080



HD1430

YEM-H9081



110848

YEM-H9082



208149 NT855

YEM-H9083



30/921200 JCB

YEM-H9084



6UZ1 SH460-5/450

YEM-H9085



4JJ1 SH130-5/CXBOB

YEM-H9086



6HK1 ZX330/ZX350

YEM-H9087



6UZ1 SH460-5/450

YEM-H9088



4HK1 ZX230/ZX240-3 6HK1 ZX330/ZX350

YEM-H9089



E330D C9 E330C

YEM-H9090



6RB1T 边盖

YEM-H9091



VOLVO210B老款机芯边盖总成

YEM-H9092



VOLVO210D新款机芯边盖总成

YEM-H9093



柴油泵连接盆 E200B-320

YEM-H9094



A
B
DH300-7 D1146

YEM-H9095



DE12

YEM-H9096



机油散热器边盖 6D114 3926044

YEM-H9097



卡特 CAT

YEM-H9098



PC200-8

YEM-H9099



PC360-7

YEM-H9100



油底壳 C9 221-9806

YEM-H9101



沃尔沃 VOLVO 进气盖板

YEM-H9102



汽门室盖 6D114

YEM-H9103



发动机前盖 PC200-5

YEM-H9104



电喷汽门盖 6D107

YEM-H9105



汽门室盖 6HK1 电喷

YEM-H9106



C7.1

YEM-H9107



4HK1

YEM-H9108























6HK1

机油散热器边盖 OIL COOLER COVER

先导格座 FORERUNNER SEAT
柴油格座 FUEL FILTER HEAD

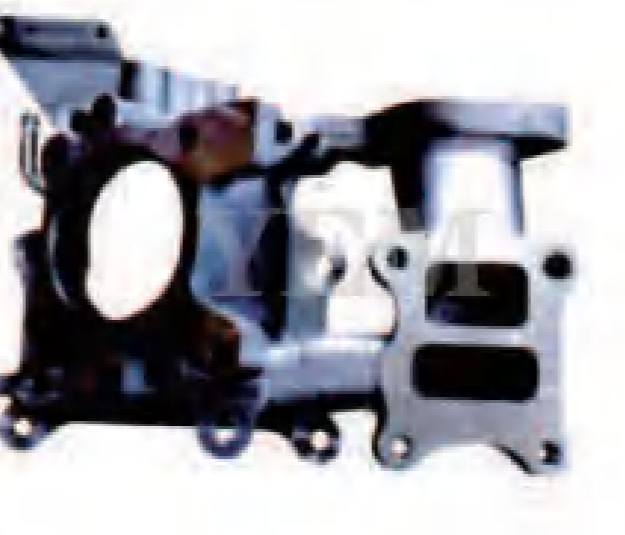



























<p>YEM-H9109</p>  <p>SK200-8 油封盖</p>	<p>YEM-H9110</p>  <p>E320C S6K 8孔</p>	<p>YEM-H9111</p>  <p>S6K柴油泵连接盘</p>	<p>YEM-H9112</p>  <p>C6.4柴油泵连接盘</p>
<p>YEM-H9113</p>  <p>ZX2003-4HK1</p>	<p>YEM-H9114</p>  <p>J05</p>	<p>YEM-H9115</p>  <p>J08</p>	<p>YEM-H9116</p>  <p>4D95连接盘</p>
<p>YEM-H9117</p>  <p>4HK1堵盖</p>	<p>YEM-H9118</p>  <p>6D95堵盖</p>	<p>YEM-H9119</p>  <p>DB58</p>	<p>YEM-H9120</p>  <p>6BG1</p>
<p>YEM-H9121</p>  <p>柴油泵连接盘 6D31</p>	<p>YEM-H9122</p>  <p>曲轴油封座 6D102 3913447</p>	<p>YEM-H9123</p>  <p>曲轴油封座 6D114/6CT8.3 3933384</p>	<p>YEM-H9124</p>  <p>现代分油中盖</p>
<p>YEM-H9125</p>  <p>PC210-8分油中盖</p>	<p>YEM-H9126</p>  <p>PC大孔分油中盖</p>	<p>YEM-H9127</p>  <p>DX150-9油封盖</p>	<p>YEM-H9128</p>  <p>沃尔沃 VOLVO 进气盖板</p>

<p>YEM-H9129</p>  <p>透明款污盾</p>	<p>YEM-H9130</p>  <p>污盾 铝</p>	<p>YEM-H9131</p>  <p>KOMATSU</p>	<p>YEM-H9132</p>  <p>PC-8</p>
<p>YEM-H9133</p>  <p>LF16352</p>	<p>YEM-H9134</p>  <p>DH300</p>	<p>YEM-H9135</p>  <p>VOLVO350</p>	<p>YEM-H9136</p>  <p>三-SANY</p>
<p>YEM-H9137</p>  <p>雷沃 福田</p>	<p>YEM-H9138</p>  <p>龙工</p>	<p>YEM-H9139</p>  <p>先导滤清器座 SK200-6</p>	<p>YEM-H9140</p>  <p>先导滤清器座 SK230-3M16</p>
<p>YEM-H9141</p>  <p>现代-9 铝先导杯</p>	<p>YEM-H9142</p>  <p>308-7298</p>	<p>YEM-H9143</p>  <p>SK200-6</p>	<p>YEM-H9144</p>  <p>五十铃新款 ZX350-5A 三一厦工 8983129180带泵</p>
<p>YEM-H9145</p>  <p>FF1098 柴油格座</p>	<p>YEM-H9146</p>  <p>0714</p>	<p>YEM-H9147</p>  <p>PC400-6</p>	<p>YEM-H9148</p>  <p>6D114 进气 6743-11-4810</p>
<p>YEM-H9149</p>  <p>6D125 发动机架 OEM:6150-821-5720</p>	<p>YEM-H9150</p>  <p>CAT</p>	<p>YEM-H9151</p>  <p>6D125 PC400-7</p>	<p>YEM-H9152</p>  <p>C9托架</p>



节温器座 SEAT THERMOSTAT

节温器 THERMOSTAT









<p>YEM-H9153</p>  <p>VOLVO360 20749399</p>	<p>YEM-H9154</p>  <p>EC700</p>	<p>YEM-H9155</p>  <p>V2403 V2303</p>	<p>YEM-H9156</p>  <p>v2607</p>
<p>YEM-H9157</p>  <p>V3300 V3800</p>	<p>YEM-H9158</p>  <p>6BG1节温器上座弯头</p>	<p>YEM-H9159</p>  <p>6BG1新款结温器座</p>	<p>YEM-H9160</p>  <p>S6K节温器上座</p>
<p>YEM-H9161</p>  <p>日立70节温器上座</p>	<p>YEM-H9162</p>  <p>SK75节温器上座</p>	<p>YEM-H9163</p>  <p>4D95进气接头</p>	<p>YEM-H9164</p>  <p>SK200-8节温器上座</p>
<p>YEM-H9165</p>  <p>SK200-8节温器下座</p>	<p>YEM-H9166</p>  <p>6D114 19H093</p>	<p>YEM-H9167</p>  <p>SK200-8</p>	<p>YEM-H9168</p>  <p>沃尔沃 VOLVO</p>
<p>YEM-H9169</p>  <p>KATO</p>	<p>YEM-H9170</p>  <p>E320C 节温器座</p>	<p>YEM-H9171</p>  <p>CAT 367-1817 4133L066 PERKINS</p>	<p>YEM-H9172</p>  <p>CAT 4133L067 PERKINS</p>

<p>YEM-H9173</p>  <p>PC300-8 5273373 THERMOSTAT</p>	<p>YEM-H9174</p>  <p>R300 6CT THERMOSTAT</p>	<p>YEM-H9175</p>  <p>4BT3.9 THERMOSTAT</p>	<p>YEM-H9176</p>  <p>4JG1 THERMOSTAT</p>
<p>YEM-H9177</p>  <p>VOLVO 99431512</p>	<p>YEM-H9178</p>  <p>6D14 THERMOSTAT</p>	<p>YEM-H9179</p>  <p>H06CT 04016-6044 THERMOSTAT</p>	<p>YEM-H9180</p>  <p>SK超8 THERMOSTAT</p>
<p>YEM-H9181</p>  <p>4M40 节温器 THERMOSTAT</p>	<p>YEM-H9182</p>  <p>久保田 1E399-73010</p>	<p>YEM-H9183</p>  <p>久保田 1A021-73012 V2203</p>	<p>YEM-H9184</p>  <p>久保田 1C011-73010 V3307</p>
<p>YEM-H9185</p>  <p>久保田 19434-73014 V1903</p>	<p>YEM-H9186</p>  <p>CAT E330B C6121 THERMOSTAT</p>	<p>YEM-H9187</p>  <p>E325D 125-5869</p>	<p>YEM-H9188</p>  <p>CAT 305.5E</p>
<p>YEM-H9189</p>  <p>DX470 DOOSAN SCANIA</p>	<p>YEM-H9190</p>  <p>DH370-7 利勃海尔944</p>	<p>YEM-H9191</p>  <p>帕金斯 PERKINS 312D2 4133L507 254-2267</p>	<p>YEM-H9192</p>  <p>帕金斯 PERKINS NEW 4177782</p>
<p>YEM-H9193</p>  <p>1830120C2 帕金斯 PERKINS</p>	<p>YEM-H9194</p>  <p>CAT</p>	<p>YEM-H9195</p>  <p>254-2268 4133L508 PERKINS</p>	<p>YEM-H9196</p>  <p>ISBE OEM:3967195</p>
<p>YEM-H9197</p>  <p>ISM11 OEM:4952630 4952630</p>	<p>YEM-H9198</p>  <p>M11OEM:3076489</p>	<p>YEM-H9199</p>  <p>SK460-8 P11C S1632-09020</p>	<p>YEM-H9200</p>  <p>JCB 320 104618</p>



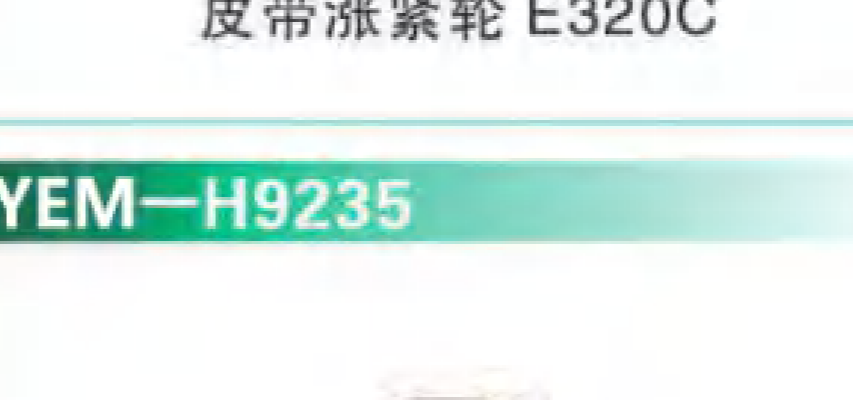
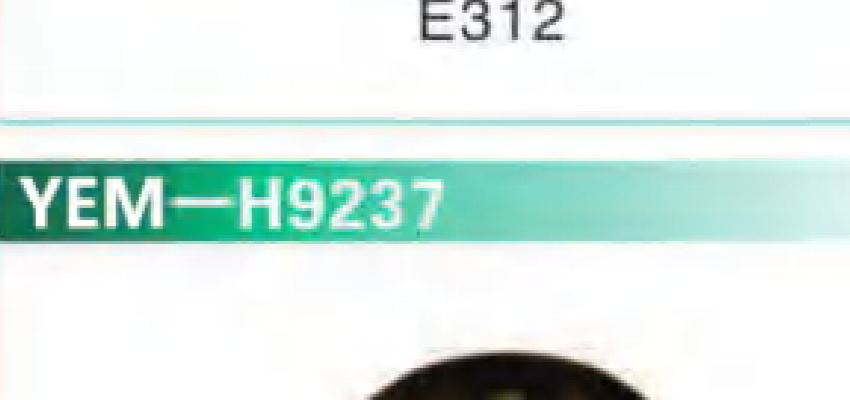
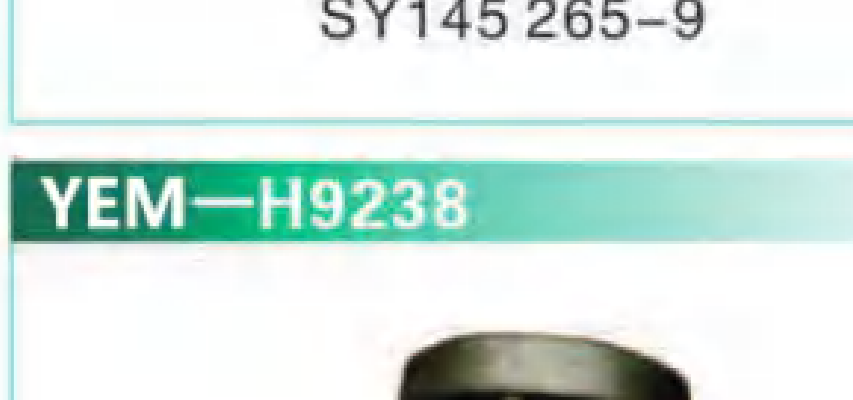
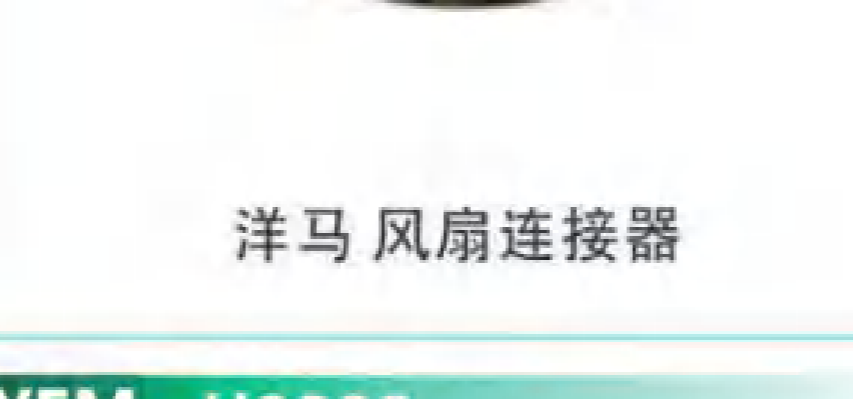
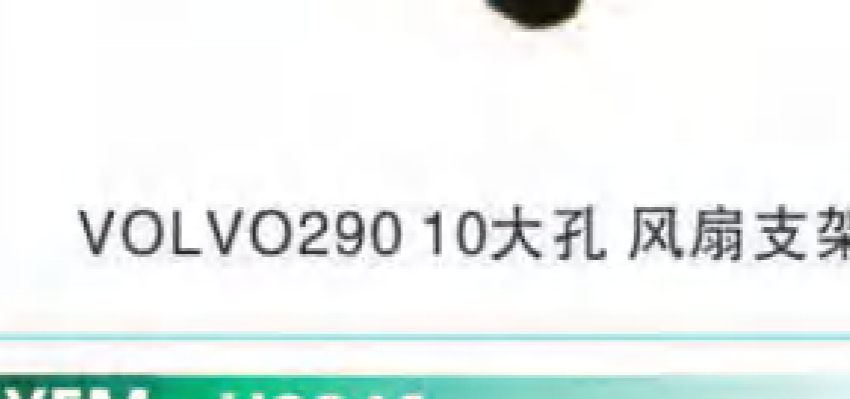
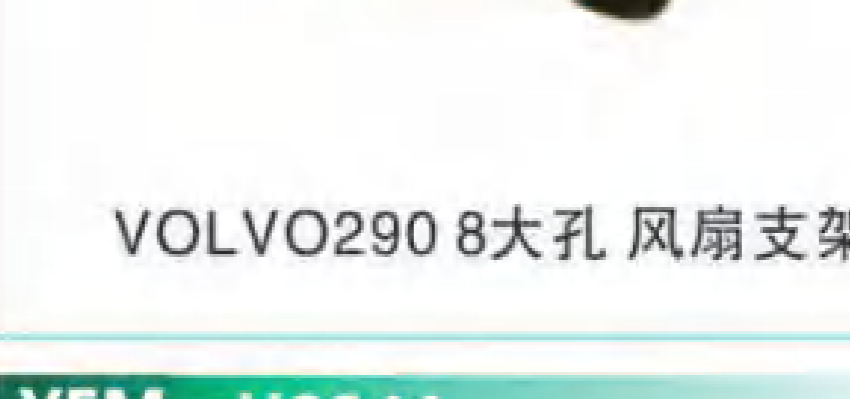

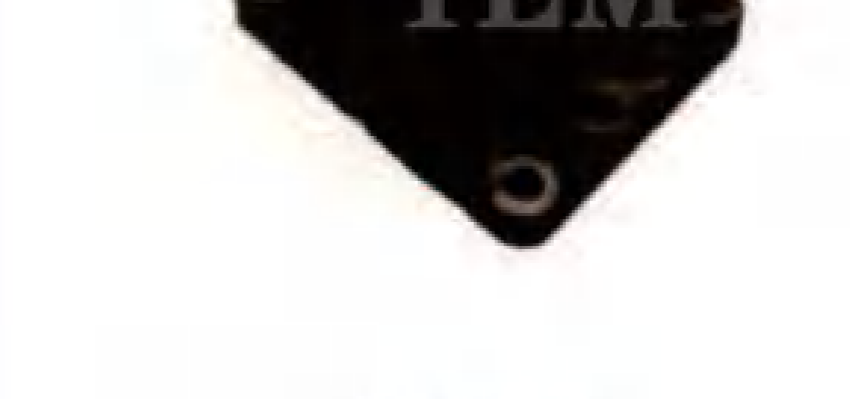















进气铝管 AIRINTER TUBE

<p>YEM-H9201</p>  <p>6D31 6D34 进气管</p>	<p>YEM-H9202</p>  <p>4D95 进气管</p>	<p>YEM-H9203</p>  <p>6D95 进气管</p>	<p>YEM-H9204</p>  <p>6BD1 进气管</p>
<p>YEM-H9205</p>  <p>PC200-7/8 增压器铁管</p>	<p>YEM-H9206</p>  <p>PC300-7/8 增压器铁管</p>	<p>YEM-H9207</p>  <p>ZAX200 进气铝管AIR INTER TUBE</p>	<p>YEM-H9208</p>  <p>EX200-5 进气铝管AIR INTER TUBE</p>
<p>YEM-H9209</p>  <p>6D102 进气管AIR INLET TUBE</p>	<p>YEM-H9210</p>  <p>J05 进气管</p>	<p>YEM-H9211</p>  <p>PC200-6 6D95 增压器铁管 TURBO TUBE</p>	<p>YEM-H9212</p>  <p>PC200-3 增压器铁管 TURBO TUBE</p>
<p>YEM-H9213</p>  <p>EX200 6BD1 增压器铁管 TURBO TUBE</p>	<p>YEM-H9214</p>  <p>SH280 6BD1 增压器铁管 TURBO TUBE</p>	<p>YEM-H9215</p>  <p>分水铝管 E200B/320/320B/C</p>	<p>YEM-H9216</p>  <p>分水铝管 DH300-5/7 D1146</p>
<p>YEM-H9217</p>  <p>机油泵弯管 C9 234-0203</p>	<p>YEM-H9218</p>  <p>ZAX200电喷液压管接头</p>	<p>YEM-H9219</p>  <p>ZAX200电喷液压管接头</p>	<p>YEM-H9220</p>  <p>ZAX2006HK1液压管接头</p>
<p>YEM-H9221</p>  <p>ZAX300电喷液压管接头</p>	<p>YEM-H9222</p>  <p>ZAX300直喷液压管接头</p>	<p>YEM-H9223</p>  <p>ZAX300直喷液压管接头</p>	<p>YEM-H9224</p>  <p>卡特C7机油泵连接管</p>
<p>YEM-H9225</p>  <p>卡特C7高压泵弯管 234-0203</p>	<p>YEM-H9226</p>  <p>卡特高压泵弯管 194-475</p>		

皮带轮系列 BELT TENSIONER

<p>YEM-H9227</p>  <p>风扇皮带轮 VOLVO240/290 双槽</p>	<p>YEM-H9228</p>  <p>VOLVO EC480 P20524754</p>	<p>YEM-H9229</p>  <p>PC200-8</p>	<p>YEM-H9230</p>  <p>徐工700</p>
<p>YEM-H9231</p>  <p>皮带涨紧轮 E320C</p>	<p>YEM-H9232</p>  <p>皮带涨紧轮 E320D C6.4</p>	<p>YEM-H9233</p>  <p>E312</p>	<p>YEM-H9234</p>  <p>SY145 265-9</p>
<p>YEM-H9235</p>  <p>洋马 风扇连接器</p>	<p>YEM-H9236</p>  <p>VOLVO290 10大孔 风扇支架</p>	<p>YEM-H9237</p>  <p>VOLVO290 8大孔 风扇支架</p>	<p>YEM-H9238</p>  <p>VOLVO360 驱动装置</p>
<p>YEM-H9239</p>  <p>JCB</p>	<p>YEM-H9240</p>  <p>E320D2</p>	<p>YEM-H9241</p>  <p>PC360-7(6D114) 34 5313 风扇支架 优质</p>	<p>YEM-H9242</p>  <p>风扇支架 PC300 5295979</p>
<p>YEM-H9243</p>  <p>约翰迪尔</p>	<p>YEM-H9244</p>  <p>PC200-5 6D95</p>	<p>YEM-H9245</p>  <p>风扇支架 DX300 DH370</p>	<p>YEM-H9246</p>  <p>徐工150 4933464</p>



































皮带轮系列 BELT TENSIONER

<p>YEM-H9247</p>  <p>E320 C7/C9/C15 133-7023</p>	<p>YEM-H9248</p>  <p>H50 CAT QSX</p>	<p>YEM-H9249</p>  <p>CAT C4.4 261-0428</p>	<p>YEM-H9250</p>  <p>C6.6 C7.1 377-9255</p>
<p>YEM-H9251</p>  <p>E320D2 C6.6 C7.2 348-5434</p>	<p>YEM-H9252</p>  <p>卡特 CAT</p>	<p>YEM-H9253</p>  <p>VOLVO360 QSX15 3681587</p>	<p>YEM-H9254</p>  <p>E350D 21390528</p>
<p>YEM-H9255</p>  <p>DX350 2129402 SCANIA</p>	<p>YEM-H9256</p>  <p>DX 带槽 2129404 SCANIA</p>	<p>YEM-H9257</p>  <p>涨紧轮 玉柴</p>	<p>YEM-H9258</p>  <p>4DK 6DK DEUTZ</p>
<p>YEM-H9259</p>  <p>约翰迪尔 TS350</p>	<p>YEM-H9260</p>  <p>QSM11</p>	<p>YEM-H9261</p>  <p>轮控/调整轮/涨紧轮 E320B</p>	<p>YEM-H9262</p>  <p>山猫 6735884</p>
<p>YEM-H9263</p>  <p>JCB005</p>	<p>YEM-H9264</p>  <p>JCB007</p>	<p>YEM-H9265</p>  <p>JCB9029</p>	<p>YEM-H9266</p>  <p>JCB9030</p>

皮带轮系列 BELT TENSIONER

<p>YEM-H9267</p>  <p>凯斯 2852161</p>	<p>YEM-H9268</p>  <p>凯斯 RE68115</p>	<p>YEM-H9269</p>  <p>凯斯195/210 84187972</p>	<p>YEM-H9270</p>  <p>1333544 利勃海尔 LIEBHERR</p>
<p>YEM-H9271</p>  <p>JCB 320-08623</p>	<p>YEM-H9272</p>  <p>皮带涨紧轮 JCB 320-08729</p>	<p>YEM-H9273</p>  <p>久保田161 5632697</p>	<p>YEM-H9274</p>  <p>DX380/450/480带槽 2197004 SCANIA</p>
<p>YEM-H9275</p>  <p>M11 OEM:3102888/3400885</p>	<p>YEM-H9276</p>  <p>DX380/500 不带槽 2197391 SCANIA</p>	<p>YEM-H9277</p>  <p>EX870 N14 3095684</p>	<p>YEM-H9278</p>  <p>C9.3 QSX/ISX15 徐工470 3681581</p>
<p>YEM-H9279</p>  <p>徐工柳工 QSX/ISX15</p>	<p>YEM-H9280</p>  <p>ISF3.8L 4780639</p>	<p>YEM-H9281</p>  <p>约翰迪尔240 RE548027</p>	<p>YEM-H9282</p>  <p>中联山河智能 QSL9L</p>
<p>YEM-H9283</p>  <p>R2000 9062004570</p>	<p>YEM-H9284</p>  <p>BDTW2227 612600062227</p>	<p>YEM-H9285</p>  <p>利勃海尔 123-8381</p>	<p>YEM-H9286</p>  <p>C11 C13 E330C 227-8313</p>

<p>YEM-H9287</p>  <p>CAT E320D3</p>	<p>YEM-H9288</p>  <p>CAT E345B 135-2151</p>	<p>YEM-H9289</p>  <p>E329 E330C E336D C7/C9 190-0643</p>	<p>YEM-H9290</p>  <p>E385/390 C18 190-0649</p>
<p>YEM-H9291</p>  <p>CAT E345 211-7895</p>	<p>YEM-H9292</p>  <p>CAT E345 C13 C15 211-7895</p>	<p>YEM-H9293</p>  <p>CAT E320D2 E329D2 C6.6 C7.1 344-1722</p>	<p>YEM-H9294</p>  <p>CAT E315/318 C4 377-9087</p>
<p>YEM-H9295</p>  <p>312D2 C4.4 369-1255</p>	<p>YEM-H9296</p>  <p>CAT E340D2 12PK 324-3218</p>	<p>YEM-H9297</p>  <p>CAT E349E 14PK 172-4738</p>	<p>YEM-H9298</p>  <p>卡特CAT E336D2</p>
<p>YEM-H9299</p>  <p>CAT E385 3691280 347-7963</p>	<p>YEM-H9300</p>  <p>CAT 219-7489</p>	<p>YEM-H9301</p>  <p>VOLVO 21819687</p>	<p>YEM-H9302</p>  <p>临工VOLVO 21750781</p>
<p>YEM-H9303</p>  <p>VOLVO 达夫 山重JCM80 4891116</p>	<p>YEM-H9304</p>  <p>VOLVO EC350D 209 39284 皮带涨紧轮</p>	<p>YEM-H9305</p>  <p>VOLVO 皮带涨紧轮 3154315 1664973 8149788</p>	<p>YEM-H9306</p>  <p>道依茨 皮带涨紧轮</p>

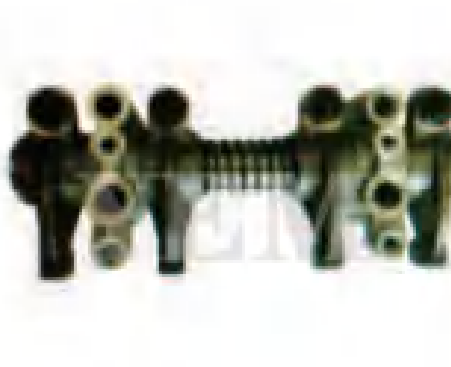
<p>YEM-H9307</p>  <p>A 4HK1摇臂铁座</p>  <p>B 4JB1摇臂铝座</p>  <p>C 4TNV94摇臂铁座</p>  <p>D 4TNV94摇臂座边</p>  <p>E 4TNV94摇臂座中</p>  <p>F 6BD1摇臂铝座单孔</p>
<p>YEM-H9308</p>  <p>A 6BD1摇臂铝座两孔</p>  <p>B 6D16摇臂铁座两孔</p>  <p>C 6D16摇臂铁座三孔</p>  <p>D 6D34摇臂轴铁座</p>  <p>E 6D34摇臂轴铁座</p>  <p>F 6D34摇臂轴铁座</p>
<p>YEM-H9309</p>  <p>A 6D34摇臂轴铁座NO.7</p>  <p>B 6D95摇臂铝座两孔</p>  <p>C 6D95摇臂铝座三孔</p>  <p>D D1146-DE08摇臂铝座</p>  <p>E J05E摇臂铁座边两孔</p>  <p>F J05E摇臂铁座中</p>
<p>YEM-H9310</p>  <p>A J05E摇臂铁座边一孔</p>  <p>B J08E摇臂铝座</p>  <p>C S6K摇臂铝座</p>  <p>D 6D16T通孔摇臂座</p>  <p>E 6D16T不通孔摇臂座</p>  <p>F J08摇臂隔套</p>
<p>YEM-H9311</p>  <p>A 6D102摇臂轴总成</p>  <p>B 60107摇臂轴总成</p>  <p>C 6D114摇臂轴总成</p>  <p>D D6D老款边1</p>  <p>E D6D老款边2</p>  <p>F D6D老款中</p>
<p>YEM-H9312</p>  <p>A D6D摇臂总成边1</p>  <p>B D6D摇臂总成边2</p>  <p>C D6D摇臂总成中</p>  <p>D D7D摇臂总成边1</p>  <p>E D7D摇臂总成中</p>  <p>F D1146-DE08 摇臂轴总成</p>

YEM—H9313

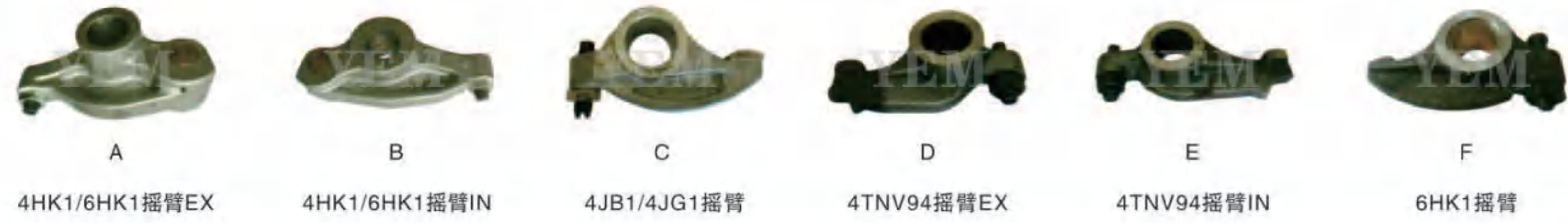

A 4HK1/6HK1摇臂EX B 4HK1/6HK1摇臂IN C 4JB1/4JG1摇臂 D 4TNV94摇臂EX E 4TNV94摇臂IN F 6HK1摇臂

YEM—H9314



A 6D16摇臂 B 6D34摇臂 C 6D95摇臂 D 6D108摇臂 E 6D125摇臂EX F 6D125摇臂IN

YEM—H9315



A 6SD1气门摇臂 B 6WG1摇臂 C C9摇臂EX D C9摇臂IN E D1146-DE08摇臂 F S6K摇臂

YEM—H9316



A J05/J08E摇臂EX B J05/J08E摇臂IN C M11摇臂 3069020-3896642 D M11摇臂 4003911-4003903 E M11摇臂 4003913-4003905 F M11摇臂 4003914-4003906

YEM—H9317



A 4D31-6D31 B 4D95-6D95 C 4HK1-6HK1 D 4JB1-4JG1挖机版 E 4JB1汽车版21T F 4M40

YEM—H9318



A 4TNV94-98 B 6BD1-6BG1-DB58 C 6D16-DB6R-42T D 6D16T-52T E 6D24T F 6D31T G 6D34T

YEM—H9319



A 6D102 B 6D107 C 6D108T D 6D114 E 6D125 F J05E-J08E G S6KT

YEM—H9320



A 4D95-6D95 凸轮轴齿 B 4HK1-6HK1 凸轮轴齿 C 4JB1-4JG1 凸轮轴齿 D 4TNV94-98 凸轮轴齿 E 6BD1-6BG1-DB58 凸轮轴齿 F 6D34凸轮轴齿

YEM—H9321



A 6D102凸轮轴齿 B 6D107凸轮轴齿 C 6D114凸轮轴齿 D C9凸轮轴齿轮 E J05E凸轮轴齿 F J08E凸轮轴齿

YEM—H9322



A S4K-S6K凸轮轴齿 B 4M40凸轮齿单 C 4M40凸轮齿双 D 4D95-6D95 E 4HK1-6HK1电喷34T F 4HK1-6HK1电喷41T

YEM—H9323



A 4HK1-6HK1 电喷61T B 4HK1-6HK1 电喷三联齿 C 4JB1-4JG1-31T D 4JB1-4JG1-37T E 4JB1-4JG1-43T F 4JB1-4JG1-52T G 4M40过桥齿单

YEM—H9324



A 4M40过桥齿双 B 4TNV94-98 C J05E缸盖齿47T厚 D J08E缸盖齿47T薄 E 6BD1-6BG1-DB58 F 6D108(51T) G 6HK1直喷34T

YEM—H9325

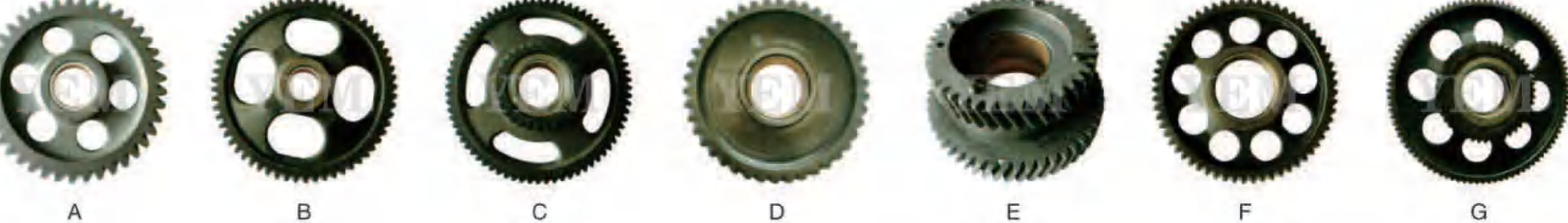

A 6HK1直喷41T B 6HK1直喷61T C 6HK1直喷双联 D D1146T-DE08 E J05E J08E 高压油泵双联齿 F J05E J08E 过桥齿61T G J05E J08E 过桥双联92+46T

YEM-H9326



YEM-H9327



YEM-H9328



YEM-H9329



YEM-H9330



YEM-H9331



YEM-H9332

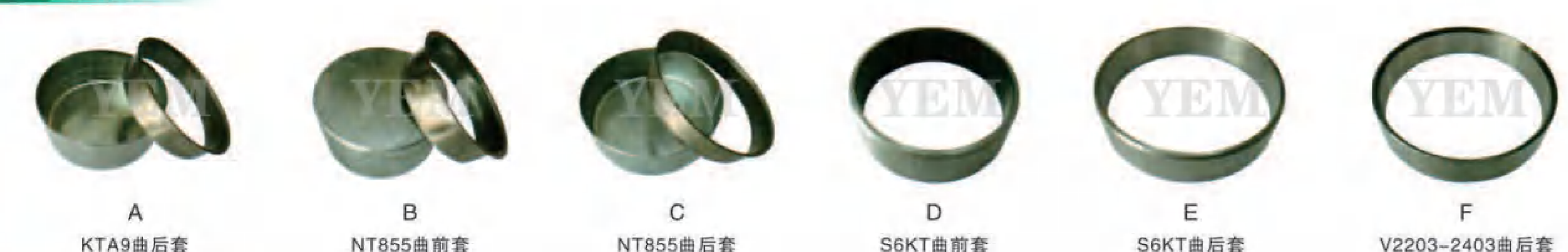

YEM-H9333



YEM-H9334

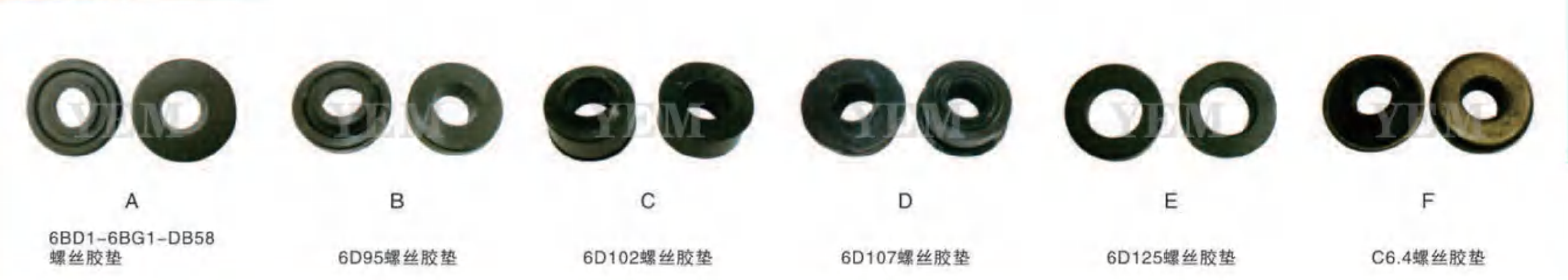

YEM-H9335



YEM-H9336



YEM-H9337



YEM-H9338



YEM—H9339



YEM—H9340



YEM—H9341



YEM—H9342



YEM—H9343



YEM—H9344



YEM—H9345



YEM—H9346



YEM—H9347



YEM—H9348



YEM—H9349



YEM—H9350



YEM—H9351 连杆螺丝系列/CONNECTING ROD BOLT



YEM—H9352 连杆螺丝系列/CONNECTING ROD BOLT



YEM—H9353 连杆螺丝系列/CONNECTING ROD BOLT



YEM—H9354 排气支管螺丝系列 EXHAUSTMANIFOD BOLT



YEM—H9355 排气支管螺丝系列 EXHAUSTMANIFOD BOLT



YEM—H9356 排气支管螺丝系列 EXHAUSTMANIFOD BOLT



YEM—H9357 调整螺丝/喷油器固定螺丝系列 ROCKER ARM BOLT

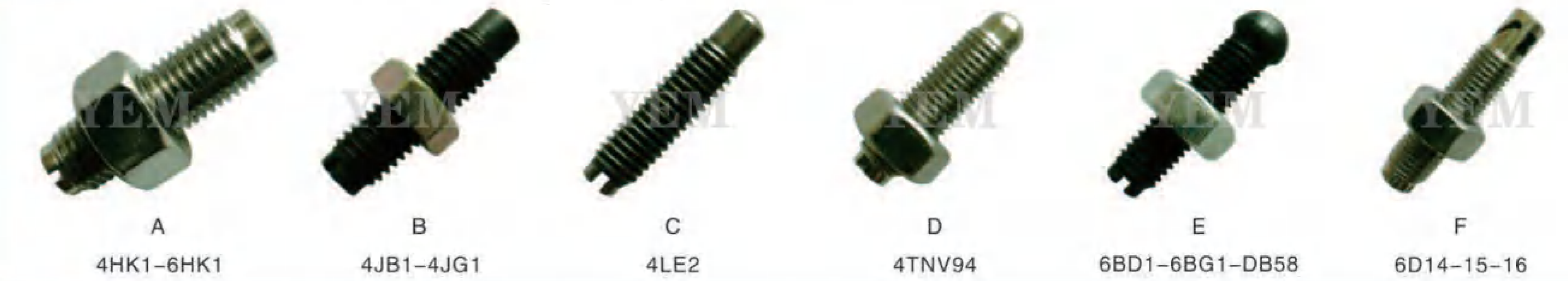

YEM—H9358 调整螺丝/喷油器固定螺丝系列 ROCKER ARM BOLT

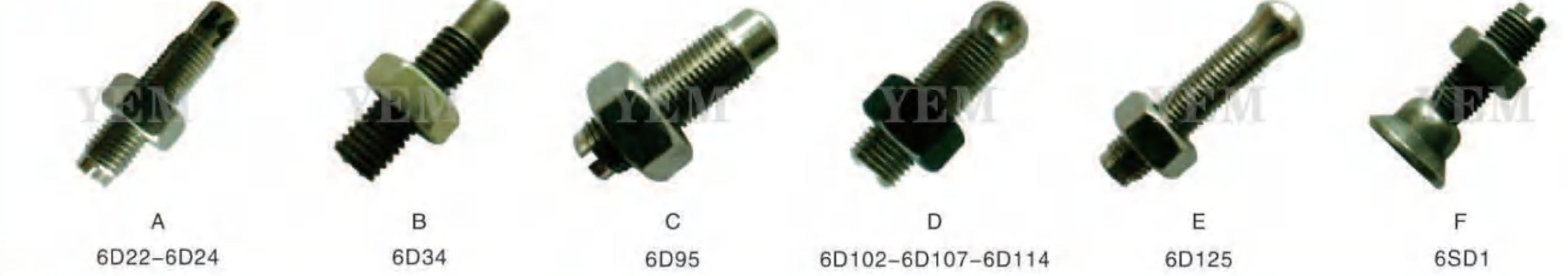

YEM—H9359 调整螺丝/喷油器固定螺丝系列 ROCKER ARM BOLT



YEM—H9360 调整螺丝/喷油器固定螺丝系列 ROCKER ARM BOLT



YEM—H9361 气门室盖螺丝系列 BOLT



YEM—H9362 气门室盖螺丝系列 BOLT



YEM—H9363 定位销系列 PIN



YEM—H9364 定位销系列 PIN



YEM—H9365 定位销系列 PIN



YEM—H9366 定位销系列 PIN

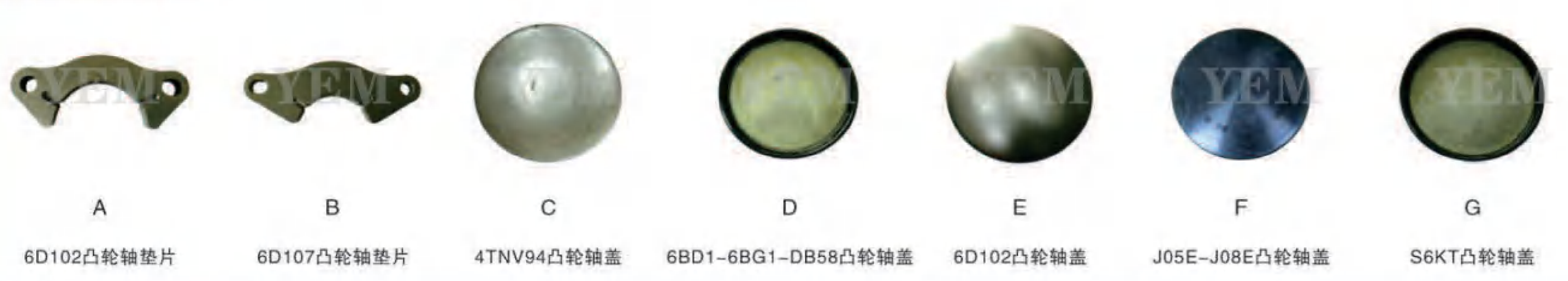

YEM—H9367 定位销系列 PIN



YEM—H9368 定位销系列 PIN



YEM—H9369 缸盖T型架系列 CYLINDER HEAD T ROCKER



YEM—H9370 缸盖T型架系列 CYLINDER HEAD T ROCKER

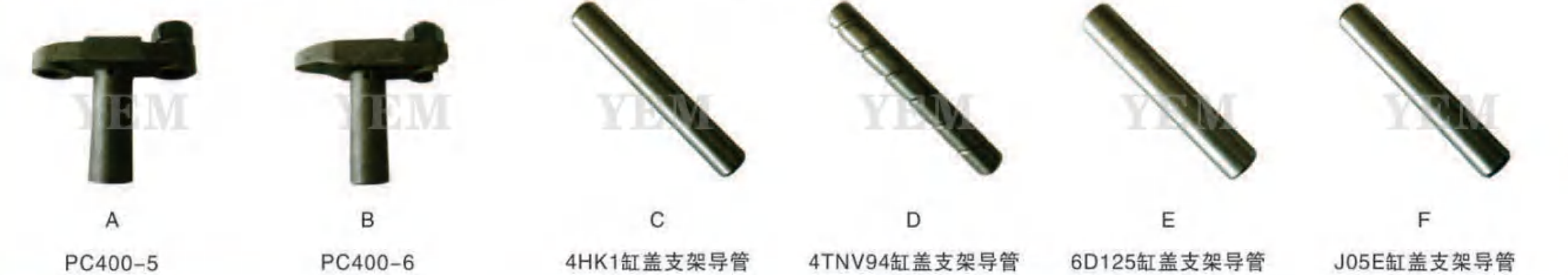

YEM—H9371 缸盖T型架系列 CYLINDER HEAD T ROCKER



YEM—H9372 4M40时规系列 TIME GAUGE SERIES



YEM—H9373 4M40时规系列 TIME GAUGE SERIES



YEM—H9374 4M40时规系列 TIME GAUGE SERIES



YEM—H9375 气门摇臂散件系列 ROCKER ARM



YEM—H9376 气门摇臂散件系列 ROCKER ARM



YEM—H9377 气门摇臂散件系列 ROCKER ARM



YEM—H9378 气门弹簧系列 VALVE SPRING



YEM—H9379 气门弹簧系列 VALVE SPRING



YEM—H9380 气门弹簧系列 VALVE SPRING



YEM—H9381 锁片帽系列/VALVE LOCK



YEM—H9382 锁片帽系列/VALVE LOCK



YEM—H9383 锁片帽系列/VALVE LOCK



YEM—H9384 锁片帽系列/VALVE LOCK



YEM—H9385 连杆系列 CONNECTING ROD ASS'Y



YEM—H9386 连杆系列 CONNECTING ROD ASS'Y



油门电机 THROTTLE MOTOR

油门电机 THROTTLE MOTOR



<p>YEM-H9387</p> <p>DH220-5圆形</p>	<p>YEM-H9388</p> <p>DH225-7方形短线</p>	<p>YEM-H9389</p> <p>DH370-7方形长线</p>	<p>YEM-H9390</p> <p>E320B</p>
<p>YEM-H9391</p> <p>E320C</p>	<p>YEM-H9392</p> <p>E320D2</p>	<p>YEM-H9393</p> <p>E320V1</p>	<p>YEM-H9394</p> <p>E320V2</p>
<p>YEM-H9395</p> <p>E330B</p>	<p>YEM-H9396</p> <p>EX200-1</p>	<p>YEM-H9397</p> <p>EX200-5</p>	<p>YEM-H9398</p> <p>HD700短线</p>

<p>YEM-H9399</p> <p>Hd1250长线</p>	<p>YEM-H9400</p> <p>PC200-5</p>	<p>YEM-H9401</p> <p>PC200-6</p>	<p>YEM-H9402</p> <p>PC200-7</p>
<p>YEM-H9403</p> <p>R215-7方形短线</p>	<p>YEM-H9404</p> <p>R215-9短线</p>	<p>YEM-H9405</p> <p>R220-5圆形短线</p>	<p>YEM-H9406</p> <p>R220-5圆形长线</p>
<p>YEM-H9407</p> <p>R275-9长线</p>	<p>YEM-H9408</p> <p>R335-7方形长线</p>	<p>YEM-H9409</p> <p>SK200-3-5</p>	<p>YEM-H9410</p> <p>SK200-6</p>
<p>YEM-H9411</p> <p>福田中联单插12V24V</p>	<p>YEM-H9412</p> <p>福田中联双联12V24V</p>	<p>YEM-H9413</p> <p>力士德</p>	<p>YEM-H9414</p> <p>柳工</p>
<p>YEM-H9415</p> <p>三一1.5米、AC1500</p>	<p>YEM-H9416</p> <p>三一1米、AC1000</p>	<p>YEM-H9417</p> <p>三一2米、AC2000</p>	<p>YEM-H9418</p> <p>三一75</p>

油门电机 THROTTLE MOTOR

电脑版/控制面板
COMPUTER BOARD/CONTROL PANEL

<p>YEM-H9419</p>  <p>CAT307C/D 油门马达</p>	<p>YEM-H9420</p>  <p>E308 油门马达</p>	<p>YEM-H9421</p>  <p>E308油门马达</p>	<p>YEM-H9422</p>  <p>DX60 12V</p>	
<p>YEM-H9423</p>  <p>VOLVO75 油门电机 15702583P01</p>	<p>YEM-H9424</p>  <p>临工 油门电机4130003322</p>	<p>YEM-H9425</p>  <p>洋马电控执行器</p>	<p>YEM-H9426</p>  <p>R60-9油门马达</p>	
<p>YEM-H9427</p>  <p>徐工</p>	<p>YEM-H9428</p>  <p>山重330338</p>	<p>YEM-H9429</p>  <p>全能王单线自动 24V</p>	<p>YEM-H9430</p>  <p>全能王双线自动 24V</p>	
<p>YEM-H9431</p>  <p>油门旋钮 CAT E307</p>	<p>YEM-H9432</p>  <p>ZAX200-5G</p>	<p>YEM-H9433</p>  <p>ZAX70 ZAX120-6 3键</p>	<p>YEM-H9434</p>  <p>山河智能 油门旋钮</p>	
<p>YEM-H9435</p>  <p>沃德雷沃 油门旋钮</p>	<p>YEM-H9436</p>  <p>龙工/福田/雷沃/夏工/中联 油门旋钮</p>	<p>YEM-H9437</p>  <p>龙工 油门旋钮</p>	<p>YEM-H9438</p>  <p>柳工 油门旋钮</p>	<p>YEM-H9439</p>  <p>徐工 油门旋钮</p>

<p>YEM-H9440</p>  <p>电脑版 Controller CAT320119-0609X-00</p>	<p>YEM-H9441</p>  <p>电脑版 Controller PERKINS CAT</p>	<p>YEM-H9442</p>  <p>电脑版 Controller SK120-2 LP22E00004F2</p>	<p>YEM-H9443</p>  <p>电脑版Controller(Big) PC200-6/220-6(大板) 7824-12-2001</p>
<p>YEM-H9444</p>  <p>电脑版Controller HYUNDAI 21Q6-32105/02</p>	<p>YEM-H9445</p>  <p>HYUNDAI 21Q4-32410</p>	<p>YEM-H9446</p>  <p>R60-9 电脑版 Controller</p>	<p>YEM-H9447</p>  <p>电脑版 Controller VOLVO EC240 010817</p>
<p>YEM-H9448</p>  <p>VOLVO210/290 60100000P11</p>	<p>YEM-H9449</p>  <p>电脑版 Controller SK350-8</p>	<p>YEM-H9450</p>  <p>SK140-8 32G87-31030 24V</p>	<p>YEM-H9451</p>  <p>4TNV98-ZCVFNC 129926-75030</p>
<p>YEM-H9452</p>  <p>日立HITACHI显示屏Monitor</p>	<p>YEM-H9453</p>  <p>ZAX200-1显示屏Monitor</p>	<p>YEM-H9454</p>  <p>E320D 显示屏Monitor</p>	<p>YEM-H9455</p>  <p>514-0566</p>
<p>YEM-H9456</p>  <p>CAT 显示屏Monitor</p>	<p>YEM-H9457</p>  <p>E320D2 显示屏Monitor</p>	<p>YEM-H9458</p>  <p>PC200-8MO 显示屏Monitor</p>	<p>YEM-H9459</p>  <p>SK350-8 显示屏Monitor</p>

电脑版/控制面板
COMPUTER BOARD/CONTROL PANEL

检测仪 SURVEY METER/DETECTOR

YEM-H9460  神钢10显示器	YEM-H9461  神钢SK200-6	YEM-H9462  VOLVO480D 显示屏Monitor	YEM-H9463  SH200A3显示屏Monitor
YEM-H9464  HYUNDAI R225-7	YEM-H9465  HYUNDAI	YEM-H9466  HYUNDAI	YEM-H9467  HYUNDAI
YEM-H9468  HYUNDAI 21EN-00200	YEM-H9469  斗山显示屏(NEW)	YEM-H9470  柳工	YEM-H9471  显示屏Monitor 三一重工
YEM-H9472  夏工	YEM-H9473  空调面板CAT	YEM-H9474  利勃海尔	YEM-H9475  VOLVO60 控制面板
YEM-H9476  大灯雨刮控制器 CAT320C	YEM-H9477  大灯控制器 CAT320D 227-7575	YEM-H9478  CAT 450-7174	YEM-H9479  DOOSAN 543-00096
YEM-H9480  DOOSAN	YEM-H9481  HYUNDAI R215-9 21Q6-30601	YEM-H9482  VOLVO EC480 14594714	YEM-H9483  控制台 SK 200-3

YEM-H9484  PC-8系列检测仪	YEM-H9485  CAT ET CAT Survey Meter	YEM-H9486  CAT 卡特新款ET4代	YEM-H9487  日立手机板检测仪 EX Surver Meter/detector (Hanelphone)
YEM-H9488  日立PC板检测仪	YEM-H9489  SK60	YEM-H9490  SK-10	YEM-H9491  SK-8检测仪 日野 SK-8 Survey Meter/Detector
YEM-H9492  VOLVO 检测仪	YEM-H9493  VOLVO NEW	YEM-H9494  HYUNDAI	YEM-H9495  ISUZU 五十铃检测仪
YEM-H9496  液压泵流量控制器	YEM-H9497  检测仪	YEM-H9498  洋马 YANIMAR	YEM-H9499  康明斯6代
YEM-H9500  时间调时器	YEM-H9501  帕金斯 Perkins	YEM-H9502  检测仪	YEM-H9503  油门电机检测仪

点火开关 VARIOUS LGNITION SWITCH

点火开关 VARIOUS LGNITION SWITCH



<p>YEM-H9504</p>  <p>SK200-6点火开关 OEM:YN50S00029F1</p>	<p>YEM-H9505</p>  <p>HD820-5电喷点火开关 OEM:718-10305001</p>	<p>YEM-H9506</p>  <p>SH200A5点火开关 OEM:KHR15660</p>	<p>YEM-H9507</p>  <p>DH-5/7点火开关 OEM:2549-1153B</p>
<p>YEM-H9508</p>  <p>ZAX电喷点火开关 OEM:4448303</p>	<p>YEM-H9509</p>  <p>沃尔沃点火开关 OEM:VOE14526158</p>	<p>YEM-H9510</p>  <p>R225-7点火开关 OEM:21E6-10430</p>	<p>YEM-H9511</p>  <p>E320C(4线)点火开关 OEM:9G-7641</p>
<p>YEM-H9512</p>  <p>徐工点火开关 OEM:XE135/215</p>	<p>YEM-H9513</p>  <p>E200B(5线)点火开关 OEM:3E-0156</p>	<p>YEM-H9514</p>  <p>EX200-1点火开关 OEM:4186745</p>	<p>YEM-H9515</p>  <p>SH200A1/A2点火开关 OEM:KHR3077</p>

<p>YEM-H9516</p>  <p>EX-2/3/5点火开关 OEM:4250350</p>	<p>YEM-H9517</p>  <p>SK200-8点火开关 OEM:YN50S00026F1</p>	<p>YEM-H9518</p>  <p>HD700直喷点火开关 OEM:719-10305001</p>	<p>YEM-H9519</p>  <p>三一点火开关 OEM:SY215/235</p>
<p>YEM-H9520</p>  <p>PC200-5/6点火开关 OEM:08086-10000</p>	<p>YEM-H9521</p>  <p>PC200-7/8点火开关 OEM:08086-20000</p>	<p>YEM-H9522</p>  <p>E320B(6线)点火开关 OEM:7Y-3918</p>	<p>YEM-H9523</p>  <p>CAT E320D2</p>
<p>YEM-H9524</p>  <p>2S-2342</p>	<p>YEM-H9525</p>  <p>PC-8MO SK-10</p>	<p>YEM-H9526</p>  <p>点火开关 9901</p>	<p>YEM-H9527</p>  <p>点火开关 3000</p>
<p>YEM-H9528</p>  <p>点火开关6897</p>	<p>YEM-H9529</p>  <p>YANMAR</p>	<p>YEM-H9530</p>  <p>VOLVO</p>	<p>YEM-H9531</p>  <p>VOLVO 11444212</p>
<p>YEM-H9532</p>  <p>龙工</p>	<p>YEM-H9533</p>  <p>JCB</p>	<p>YEM-H9534</p>  <p>CAT E320GC 一键启动</p>	<p>YEM-H9535</p>  <p>CAT E306GC 526-5710双插</p>

熄火开关 FLAMEOUT SOLENOID

熄火开关 FLAMEOUT SOLENOID



<p>YEM-H9536</p>  <p>PC360-7 4063712 VDC24</p>	<p>YEM-H9537</p>  <p>PC300-7 3930234 VDC24</p>	<p>YEM-H9538</p>  <p>CAT/3035 6N-9987 VDC24</p>	<p>YEM-H9539</p>  <p>CAT/E330 125-5774 VDC24</p>
<p>YEM-H9540</p>  <p>CAT/E325C 8C-3663 VDC24</p>	<p>YEM-H9541</p>  <p>CAT/332 125-5772 VDC24</p>	<p>YEM-H9542</p>  <p>CAT/3306 110-6465 VDC24</p>	<p>YEM-H9543</p>  <p>R335-7 3939019 VDC24</p>
<p>YEM-H9544</p>  <p>R215-7 11E1-60100 VDC24</p>	<p>YEM-H9545</p>  <p>R210-5 3991625 20200611 VDC24</p>	<p>YEM-H9546</p>  <p>R130 3991168 VDC24</p>	<p>YEM-H9547</p>  <p>R220-5 3932530 VDC24</p>

<p>YEM-H9548</p>  <p>R225-7 3864274 VDC24</p>	<p>YEM-H9549</p>  <p>R215-9 11N6-66090 VDC24</p>	<p>YEM-H9550</p>  <p>SK75 897209-5680 VDC24</p>	<p>YEM-H9551</p>  <p>S6K电磁阀 1751-24E7 U1B1S5A VDC24</p>
<p>YEM-H9552</p>  <p>洋马灰插 1503ES-12S5SUC125 VDC12</p>	<p>YEM-H9553</p>  <p>ZX55 897183-0140 20200611 VDC12</p>	<p>YEM-H9554</p>  <p>三一白插 SY215-8 VDC24</p>	<p>YEM-H9555</p>  <p>康明斯B3.3 096030-0070 VDC24</p>
<p>YEM-H9556</p>  <p>17208-60010 20200611 VDC12</p>	<p>YEM-H9557</p>  <p>1G772-60012 20210228 VDC12</p>	<p>YEM-H9558</p>  <p>1A021-60017 20200611 V0012</p>	<p>YEM-H9559</p>  <p>NTA855总成 3035344-24 VDC24</p>
<p>YEM-H9560</p>  <p>M11半总成 134972-12 VDC12</p>	<p>YEM-H9561</p>  <p>NTA855半总成 3054609-12 VDC14</p>	<p>YEM-H9562</p>  <p>M11总成 3018453-12 VDC12</p>	<p>YEM-H9563</p>  <p>CAT125-5772</p>
<p>YEM-H9564</p>  <p>CAT6N-9988</p>	<p>YEM-H9565</p>  <p>4N-3890熄火开关</p>	<p>YEM-H9566</p>  <p>E305C MM409-67001</p>	<p>YEM-H9567</p>  <p>PERKINS1005 185206083</p>
<p>YEM-H9568</p>  <p>YNNMAR 熄火开关</p>	<p>YEM-H9569</p>  <p>斗山300 24V</p>	<p>YEM-H9570</p>  <p>熄火开关 久保田 16851-60010</p>	<p>YEM-H9571</p>  <p>熄火开关 D59-105-12 D59-105-24</p>

熄火开关 FLAMEOUT SOLENOID

电磁阀 SOLENOID

<p>YEM-H9572</p>  <p>熄火开关 SANY 3776852</p>	<p>YEM-H9573</p>  <p>熄火开关 0427 2956</p>	<p>YEM-H9574</p>  <p>熄火开关 道依茨</p>	<p>YEM-H9575</p>  <p>熄火开关 04272733</p>
<p>YEM-H9576</p>  <p>熄火开关 0419 9905</p>	<p>YEM-H9577</p>  <p>熄火开关 0419 9900</p>	<p>YEM-H9578</p>  <p>熄火开关 366-07197 SA-3405-T</p>	<p>YEM-H9579</p>  <p>熄火开关 2001-12E2U1 D513-A32V12 12V</p>
<p>YEM-H9580</p>  <p>熄火开关 2001-12F2U1B2A SA-2774-A12V</p>	<p>YEM-H9581</p>  <p>KUBOTA SA-4863</p>	<p>YEM-H9582</p>  <p>KUBOTA 1503ES-12A5UC9S</p>	<p>YEM-H9583</p>  <p>KUBOTA 1503ES-12A5SUC9SLC24</p>
<p>YEM-H9584</p>  <p>KOMATSU</p>	<p>YEM-H9585</p>  <p>KUBOTA</p>	<p>YEM-H9586</p>  <p>PC400-7</p>	<p>YEM-H9587</p>  <p>E312 4M40</p>
<p>YEM-H9588</p>  <p>JCB 322-J5060</p>	<p>YEM-H9589</p>  <p>SA-4754-12</p>	<p>YEM-H9590</p>  <p>600-815-7550</p>	<p>YEM-H9591</p>  <p>437-2617</p>
<p>YEM-H9592</p>  <p>1G925-60011</p>	<p>YEM-H9593</p>  <p>1G577-60010</p>	<p>YEM-H9594</p>  <p>SA-4863-24</p>	<p>YEM-H9595</p>  <p>R220-9 11N6-66090</p>
<p>YEM-H9596</p>  <p>帕金斯VOLVO 0E52318</p>			

<p>YEM-H9597</p>  <p>SH200A5 电磁阀组</p>	<p>YEM-H9598</p>  <p>玉柴 电磁阀组</p>	<p>YEM-H9599</p>  <p>玉柴 电磁阀组</p>	<p>YEM-H9600</p>  <p>玉柴 电磁阀组</p>
<p>YEM-H9601</p>  <p>厦工 电磁阀组</p>	<p>YEM-H9602</p>  <p>PC200-6/7</p>	<p>YEM-H9603</p>  <p>SANY</p>	<p>YEM-H9604</p>  <p>PC70-8电磁阀组</p>
<p>YEM-H9605</p>  <p>PC130-7电磁阀组</p>	<p>YEM-H9606</p>  <p>SK200-6E电磁阀组</p>	<p>YEM-H9607</p>  <p>川崎 电磁阀组</p>	<p>YEM-H9608</p>  <p>川崎 电磁阀组</p>
<p>YEM-H9609</p>  <p>PC60-5 电磁阀组</p>	<p>YEM-H9610</p>  <p>PC60-5 电磁阀组</p>	<p>YEM-H9611</p>  <p>PC120-5/6 电磁阀组</p>	<p>YEM-H9612</p> 
<p>YEM-H9613</p>  <p>VOLVO电磁阀组</p>	<p>YEM-H9614</p>  <p>VOLVO EC210电磁阀组</p>	<p>YEM-H9615</p>  <p>VOLVO 电磁阀组</p>	<p>YEM-H9616</p>  <p>VOLVO 电磁阀组</p>

电磁阀 SOLENOID

<p>YEM-H9617</p>  <p>现代 HYUNDAI</p>	<p>YEM-H9618</p>  <p>现代 HYUNDAI</p>	<p>YEM-H9619</p>  <p>VOLVO</p>	<p>YEM-H9620</p>  <p>VOLVO 轮控</p>
<p>YEM-H9621</p> 	<p>YEM-H9622</p>  <p>OS132051300200</p>	<p>YEM-H9623</p>  <p>JCB</p>	<p>YEM-H9624</p>  <p>31M8-30061</p>
<p>YEM-H9625</p>  <p>420-00340B</p>	<p>YEM-H9626</p>  <p>SV98-T39-6T-N-24DR</p>	<p>YEM-H9627</p>  <p>DOOSAN 2420-9325A</p>	<p>YEM-H9628</p>  <p>电磁阀</p>
<p>YEM-H9629</p>  <p>液压泵电磁阀/带座 K3V112</p>	<p>YEM-H9630</p>  <p>PC200-5电磁阀</p>	<p>YEM-H9631</p>  <p>PC56-8电磁阀组</p>	<p>YEM-H9632</p>  <p>电磁阀 140701</p>
<p>YEM-H9633</p>  <p>SK200-6电磁阀带座</p>	<p>YEM-H9634</p>  <p>液压泵电磁阀/带座 SK200-3(K3V112) 2436U1453511G</p>	<p>YEM-H9635</p>  <p>4M50 HD820 ME229905 EGR电磁阀总成</p>	<p>YEM-H9636</p>  <p>HYUNDAL 31Q6-20131</p>

电磁阀 SOLENOID

<p>YEM-H9637</p>  <p>CAT E320C E330C</p>	<p>YEM-H9638</p>  <p>液压泵电磁阀/不带座 SK200-3(K3V112) 2436U1453511G</p>	<p>YEM-H9639</p>  <p>SH350液压泵电磁阀</p>	<p>YEM-H9640</p>  <p>快换两位四通阀</p>
<p>YEM-H9641</p>  <p>4HK1</p>	<p>YEM-H9642</p>  <p>TM68601原厂 托马斯电磁阀</p>	<p>YEM-H9643</p>  <p>TM70402原厂 派克电磁阀</p>	<p>YEM-H9644</p>  <p>TM82002原厂 吊车电磁阀</p>
<p>YEM-H9645</p>  <p>TM68501原厂 徐工电磁阀</p>	<p>YEM-H9646</p>  <p>TM85302原厂 泵车电磁阀</p>	<p>YEM-H9647</p>  <p>TM68502原厂 托马斯电磁阀</p>	<p>YEM-H9648</p>  <p>TM66202原厂 托马斯电磁阀</p>
<p>YEM-H9649</p>  <p>TM70302原厂 吊车电磁阀</p>	<p>YEM-H9650</p>  <p>TM58402原厂 派克电磁阀</p>	<p>YEM-H9651</p>  <p>TM1002421原厂 托马斯电磁阀</p>	<p>YEM-H9652</p>  <p>HLPPRV06A原厂 雷沃三一国产机</p>
<p>YEM-H9653</p>  <p>HLPPRV05A原厂 雷沃三一国产机</p>	<p>YEM-H9654</p>  <p>HLSDCV05B原厂 雷沃三一国产机</p>	<p>YEM-H9655</p>  <p>SV90-G39-0-C-24ER原厂 海德福斯电磁阀</p>	<p>YEM-H9656</p>  <p>SV98-T39 24DR原厂 山东卡特 JCB国产机</p>
<p>YEM-H9657</p>  <p>SV98-T39S 24DY2A原厂 徐工装载机</p>	<p>YEM-H9658</p>  <p>TM90502原厂 托马斯电磁阀</p>	<p>YEM-H9659</p>  <p>SV98-T40S 24DY12原厂 徐工装载机</p>	<p>YEM-H9660</p>  <p>TM1012162原厂 沃尔沃200D/210D/250D</p>

电磁阀 SOLENOID

<p>YEM-H9661</p>  <p>利勃海尔33344100</p>	<p>YEM-H9662</p>  <p>利勃海尔33496000</p>	<p>YEM-H9663</p>  <p>三一485 550 700 750</p>	<p>YEM-H9664</p>  <p>三一700风扇泵电磁阀</p>
<p>YEM-H9665</p>  <p>TM90501原厂 三一柳工徐工电磁阀</p>	<p>YEM-H9666</p>  <p>1006178原厂 三一柳工徐工电磁阀</p>	<p>YEM-H9667</p>  <p>1017969原厂 三一柳工徐工电磁阀</p>	<p>YEM-H9668</p>  <p>1013365原厂 三一柳工徐工电磁阀</p>
<p>YEM-H9669</p>  <p>1017628原厂 三一柳工徐工电磁阀</p>	<p>YEM-H9670</p>  <p>T335 12V原厂 三一雷沃电磁阀</p>	<p>YEM-H9671</p>  <p>T335 24V原厂 柳工徐工雷沃电磁阀</p>	<p>YEM-H9672</p>  <p>T336 24V 三一柳工徐工电磁阀</p>
<p>YEM-H9673</p>  <p>R901155051原厂 斗山380 420龙工360 365</p>	<p>YEM-H9674</p>  <p>R900727801原厂 雷沃150 210电磁阀</p>	<p>YEM-H9675</p>  <p>R900701407原厂 卡特 三一 徐工旋挖电磁阀</p>	<p>YEM-H9676</p>  <p>R900578535原厂 力士乐M4分配阀电磁阀</p>
<p>YEM-H9677</p>  <p>TM1012162原厂 斗山215/220/225/235</p>	<p>YEM-H9678</p>  <p>PD2E1-Y32D21-24E13原厂 力士德海斗24V</p>	<p>YEM-H9679</p>  <p>PD2E1-Y32D21-12E13原厂 海斗12V</p>	<p>YEM-H9680</p>  <p>TM1005110原厂 福田85 临工968</p>
<p>YEM-H9681</p>  <p>TM58401原厂 派克电磁阀</p>	<p>YEM-H9682</p>  <p>TM60601原厂 托马斯电磁阀</p>	<p>YEM-H9683</p>  <p>TM66001原厂 托马斯电磁阀</p>	<p>YEM-H9684</p>  <p>TM68001原厂 托马斯电磁阀</p>

电磁阀 SOLENOID

<p>YEM-H9685</p>  <p>4WE6D61B-CG24N9Z5L</p>	<p>YEM-H9686</p>  <p>4WE6J61B-CG24N9Z5L</p>	<p>YEM-H9687</p>  <p>4WE6Y61B</p>	<p>YEM-H9688</p>  <p>4705919</p>
<p>YEM-H9689</p>  <p>JCB SV98-T39 24伏</p>	<p>YEM-H9690</p>  <p>DX225 DX235 EHP98-T38 24ER</p>	<p>YEM-H9691</p>  <p>徐工三节 SV-98-T40S 24伏</p>	<p>YEM-H9692</p>  <p>斗山 410116-00646</p>
<p>YEM-H9693</p>  <p>E320GC 电磁阀485-5747</p>	<p>YEM-H9694</p>  <p>E320GC 电磁阀491-0908</p>	<p>YEM-H9695</p>  <p>E320GC 电磁阀585-9230</p>	<p>YEM-H9696</p>  <p>E320GC 电磁阀585-9231</p>
<p>YEM-H9697</p>  <p>E320GC 电磁阀611-6430</p>	<p>YEM-H9698</p>  <p>EHP98-G35</p>	<p>YEM-H9699</p>  <p>F01-12D1A25-A00</p>	<p>YEM-H9700</p>  <p>F01-24D1A25-A00</p>
<p>YEM-H9701</p>  <p>F03-12D9AAC</p>	<p>YEM-H9702</p>  <p>F06-12D1AAB-A01</p>	<p>YEM-H9703</p>  <p>VOLVO 绿点14616531</p>	<p>YEM-H9704</p>  <p>R900771731原厂 力士乐电磁阀</p>

电磁阀 SOLENOID

<p>YEM-H9705</p>  <p>CAT 226-9622</p>	<p>YEM-H9706</p>  <p>AT310584 18816-3583</p>	<p>YEM-H9707</p>  <p>AT310586 310J 325K</p>	<p>YEM-H9708</p>  <p>AT310587 310J 325K</p>
<p>YEM-H9709</p>  <p>EC210C</p>	<p>YEM-H9710</p>  <p>VOLVO EC250D</p>	<p>YEM-H9711</p>  <p>25/104700</p>	<p>YEM-H9712</p>  <p>JCB 223-8181</p>
<p>YEM-H9713</p> 	<p>YEM-H9714</p>  <p>三一老款 高压 KM15-S46</p>	<p>YEM-H9715</p>  <p>三一老款 低压 KM15-S45 R900727801</p>	<p>YEM-H9716</p>  <p>R901059491</p>
<p>YEM-H9717</p>  <p>R900568316</p>	<p>YEM-H9718</p>  <p>3268317</p>	<p>YEM-H9719</p>  <p>7N90501 24V 32BAR</p>	<p>YEM-H9720</p>  <p>三一柳工徐工 THOMAS TM90501 24V 32BAR</p>
<p>YEM-H9721</p>  <p>CAT SANY 485-577 12/24V</p>	<p>YEM-H9722</p>  <p>T335-1-321 24V</p>	<p>YEM-H9723</p>  <p>HLPPRVO6A 24V</p>	

电磁阀 SOLENOID

<p>YEM-H9724</p>  <p>25/105100</p>	<p>YEM-H9725</p>  <p>KOMATSU 714-11-16840</p>	<p>YEM-H9726</p>  <p>KOMATSU 714-11-16830</p>	<p>YEM-H9727</p>  <p>CAT 244-3114</p>
<p>YEM-H9728</p>  <p>CAT186-1525 圆插</p>	<p>YEM-H9729</p>  <p>0035 0695 109-4591方插</p>	<p>YEM-H9730</p>  <p>CAT 950H-980K 328-4314 24V</p>	<p>YEM-H9731</p>  <p>CAT 977-3535</p>
<p>YEM-H9732</p>  <p>CAT 152-8346</p>	<p>YEM-H9733</p>  <p>CAT 474-9387</p>	<p>YEM-H9734</p>  <p>CAT 144-1644</p>	<p>YEM-H9735</p>  <p>CAT 3E-3748</p>
<p>YEM-H9736</p>  <p>CAT 458-2950-00</p>	<p>YEM-H9737</p>  <p>CAT 198-4607</p>	<p>YEM-H9738</p>  <p>CAT 279-6528</p>	<p>YEM-H9739</p>  <p>CAT D6R D8T D7E 380-9849</p>
<p>YEM-H9740</p>  <p>147-5399</p>	<p>YEM-H9741</p>  <p>154-3064</p>	<p>YEM-H9742</p>  <p>174-4909</p>	<p>YEM-H9743</p>  <p>CAT950G 980G 2076806</p>

电磁阀 SOLENOID

<p>YEM-H9744</p>  <p>电磁阀 4301864 3411</p>	<p>YEM-H9745</p>  <p>雷沃电磁阀12V/24V</p>	<p>YEM-H9746</p>  <p>三一-SANY 028134</p>	<p>YEM-H9747</p>  <p>三一 SANY</p>
<p>YEM-H9748</p>  <p>厦工</p>	<p>YEM-H9749</p> 	<p>YEM-H9750</p>  <p>三一 SANY</p>	<p>YEM-H9751</p>  <p>现代 RSV</p>
<p>YEM-H9752</p>  <p>DH220-5</p>	<p>YEM-H9753</p>  <p>4305724</p>	<p>YEM-H9754</p>  <p>JBC 500-2253</p>	<p>YEM-H9755</p>  <p>徐工</p>
<p>YEM-H9756</p>  <p>龙工 3036401</p>	<p>YEM-H9757</p>  <p>玉柴 SANY</p>	<p>YEM-H9758</p>  <p>YC雷沃</p>	<p>YEM-H9759</p>  <p>VOLVO</p>
<p>YEM-H9760</p>  <p>VOLVO 11705493</p>	<p>YEM-H9761</p>  <p>SANY</p>	<p>YEM-H9762</p>  <p>E336D风扇电磁阀</p>	<p>YEM-H9763</p>  <p>CAT 313-6014</p>

电磁阀 SOLENOID

<p>YEM-H9764</p>  <p>推土机电磁阀 419-18-51310 GH03056 WA270-7 320-7</p>	<p>YEM-H9765</p>  <p>卡特D型 E320D 回转电磁阀 SOLENOID VALVE</p>	<p>YEM-H9766</p>  <p>角度传感器 4716888NEW</p>	<p>YEM-H9767</p>  <p>HITACHI EX200-2/3 9258047/4288336</p>
<p>YEM-H9768</p>  <p>ZAX70 SOLENOID VALVE</p>	<p>YEM-H9769</p>  <p>小松 JCB</p>	<p>YEM-H9770</p>  <p>CAT 107-0677</p>	<p>YEM-H9771</p>  <p>E306/307 柳工906/908</p>
<p>YEM-H9772</p>  <p>4303624 333-8242</p>	<p>YEM-H9773</p>  <p>170-9419</p>	<p>YEM-H9774</p>  <p>国产小挖 SV98-T39 12V</p>	<p>YEM-H9775</p>  <p>国产小挖 SV98-T3924V</p>
<p>YEM-H9776</p>  <p>国产小挖/带阀 SV98-3912V</p>	<p>YEM-H9777</p>  <p>国产小挖/带阀SV98-3924V</p>	<p>YEM-H9778</p>  <p>海德弗斯 SV98-T4024V</p>	<p>YEM-H9779</p>  <p>川崎 G24DB50</p>
<p>YEM-H9780</p>  <p>VOLVO 11418522 24V</p>	<p>YEM-H9781</p>  <p>电磁阀 CAT 195-9700</p>	<p>YEM-H9782</p>  <p>电磁阀 JCB25/974628</p>	<p>YEM-H9783</p>  <p>KOCBELCO</p>

YEM-H9784



神钢反比例电磁阀/液泵电磁阀
(小插)KOBELCO
SK200/250-6E SK230/330-6E
SK130/260-8 SK200/330-8
SK350LC-8
KDRDE5K-31/40C50 No.0267 49F1

YEM-H9785



方向控制阀
E320B116-3526
KWE5K-31/40E30-701A

YEM-H9786



CAT
116-3506 G24E30-704

YEM-H9787



CAT 457-9878

YEM-H9788



CAT E330C114-0616

YEM-H9789



中联/龙工

YEM-H9790



SH200A3
住友SUMITOMO

YEM-H9791



卡特 CAT

YEM-H9792



ZAX450G正比例电磁阀
9218234/445599

YEM-H9793



ZAX450-5G 9314145
反比例电磁阀

YEM-H9794



PC200-8MO
702-21-56241

YEM-H9795



PC56-7 12V
702-21-56241

YEM-H9796



PC120-5/6
203-60-56180大孔
安全锁定电磁阀 SOLENOID VALVE

YEM-H9797



PC360-7
主泵电磁阀 MAIN PUMP SOLENOID

YEM-H9798



PC200-8MO 主泵电磁阀

YEM-H9799



PC200-6/7 改进款
电磁阀 SOLENOID VALVE

YEM-H9800



WA350-6 WA420-3
714-07-16730
电磁阀 SOLENOID VALVE

YEM-H9801



561-15-47210
17A-15-17271 KOMATSU

YEM-H9802



电磁阀 PC714-23-15520

YEM-H9803



56D-15-35220



YEM-H9804



PC130-8

YEM-H9805



PC200-6

YEM-H9806



PC200-7

YEM-H9807



PC200-8

YEM-H9808



E330B

YEM-H9809



E330C

YEM-H9810



E320C

YEM-H9811



E320D加长

YEM-H9812



CAT大圆

YEM-H9813



EX-5

YEM-H9814



EX450





















YEM-H9815



DH220-5

转速感应器 REVOLUTION SENSOR

转速感应器 REVOLUTION SENSOR

<p>YEM-H9816</p>  <p>R215-三菱</p>	<p>YEM-H9817</p>  <p>SK-3</p>	<p>YEM-H9818</p>  <p>SK-6</p>	<p>YEM-H9819</p>  <p>SK-8</p>
<p>YEM-H9820</p>  <p>VOLVO380</p>	<p>YEM-H9821</p>  <p>VOLVO短线</p>	<p>YEM-H9822</p>  <p>VOLVO长线</p>	<p>YEM-H9823</p>  <p>SHA1A2</p>
<p>YEM-H9824</p>  <p>VOLVO360</p>	<p>YEM-H9825</p>  <p>现代老款 康明斯</p>	<p>YEM-H9826</p>  <p>J05</p>	<p>YEM-H9827</p>  <p>J08</p>
<p>YEM-H9828</p>  <p>4HK1凸轮轴</p>	<p>YEM-H9829</p>  <p>4HK曲轴</p>	<p>YEM-H9830</p>  <p>6HK1直喷</p>	<p>YEM-H9831</p>  <p>CAT 订制款 转速传感器 REVOLUTION SENSOR</p>
<p>YEM-H9832</p>  <p>三一 SANY MC867505 转速传感器 REVOLUTION SENSOR</p>	<p>YEM-H9833</p>  <p>柴油泵转速传感器 6D16 ME755970 9443613465</p>	<p>YEM-H9834</p>  <p>6WG1 ZAX450 1-81510713-1</p>	<p>YEM-H9835</p>  <p>K19 3034572</p>

<p>YEM-H9836</p>  <p>LIUGONG 307815/4984223</p>	<p>YEM-H9837</p>  <p>康明斯双线 4327234</p>	<p>YEM-H9838</p>  <p>康明斯</p>	<p>YEM-H9839</p>  <p>PC1205-7 ZAX1200 4327239 3408472</p>
<p>YEM-H9840</p>  <p>柳工LIUGONG 920D/E</p>	<p>YEM-H9841</p>  <p>柳工907D/908CD 30B0202</p>	<p>YEM-H9842</p>  <p>徐工</p>	<p>YEM-H9843</p>  <p>山重 913 J213-92A-240001</p>
<p>YEM-H9844</p>  <p>福田雷沃 RL11-61C000003A0-1</p>	<p>YEM-H9845</p>  <p>CAT 290-5792182-8597</p>	<p>YEM-H9846</p>  <p>CAT 196-1185</p>	<p>YEM-H9847</p>  <p>CAT 17136-0123</p>
<p>YEM-H9848</p>  <p>265-903335083512</p>	<p>YEM-H9849</p>  <p>CAT258-4821-05</p>	<p>YEM-H9850</p>  <p>詹阳中控ZG40-3/4-16UNF</p>	<p>YEM-H9851</p>  <p>中联150G220-11-5TSWS</p>
<p>YEM-H9852</p>  <p>玉柴 T0411-17103</p>	<p>YEM-H9853</p>  <p>玉柴 T0411-17104</p>	<p>YEM-H9854</p>  <p>山东卡特 ZG105A</p>	<p>YEM-H9855</p>  <p>玉柴</p>
<p>YEM-H9856</p>  <p>玉柴 T0411-17102</p>			

转速感应器 REVOLUTION SENSOR

转速感应器 REVOLUTION SENSOR

<p>YEM-H9857</p>  <p>VOLVO 15193875 15001761</p>	<p>YEM-H9858</p> 	<p>YEM-H9859</p>  <p>康明斯 B3.3</p>	<p>YEM-H9860</p>  <p>Q216005</p>
<p>YEM-H9861</p>  <p>266-8576</p>	<p>YEM-H9862</p>  <p>CAT 522-1643</p>	<p>YEM-H9863</p>  <p>669 3921 BAB CAT</p>	<p>YEM-H9864</p>  <p>668 4037S100-S160 BAB CAT</p>
<p>YEM-H9865</p>  <p>K19 转速传感器</p>	<p>YEM-H9866</p>  <p>E325C 254-4630169-3300 凸轮轴传感器</p>	<p>YEM-H9867</p>  <p>CAT E320D2 384-3888 凸轮轴传感器</p>	<p>YEM-H9868</p>  <p>358-2398 凸轮轴传感器</p>
<p>YEM-H9869</p>  <p>358-2399 凸轮轴传感器</p>	<p>YEM-H9870</p>  <p>319-6491 凸轮轴传感器</p>	<p>YEM-H9871</p>  <p>E33188-7513201-6616 凸轮轴传感器</p>	<p>YEM-H9872</p>  <p>CAT 201-6615 凸轮轴传感器</p>
<p>YEM-H9873</p>  <p>216-3446</p>	<p>YEM-H9874</p>  <p>转速传感器(飞轮) 6HK1/6BG1 1-81510343-2</p>	<p>YEM-H9875</p>  <p>VOLVO 20374398</p>	<p>YEM-H9876</p>  <p>VOLVO 3172522</p>

<p>YEM-H9877</p>  <p>VOLVO 20552760 20909613 3172524</p>	<p>YEM-H9878</p>  <p>VOLVO 20761735 21068286 RENAULT 7421068286</p>	<p>YEM-H9879</p>  <p>4HK1 JCB 转速传感器</p>	<p>YEM-H9880</p>  <p>五十铃8-97122324-0</p>
<p>YEM-H9881</p>  <p>五十铃8-94370581-0</p>	<p>YEM-H9882</p>  <p>转速传感器 VOLVOD3.8</p>	<p>YEM-H9883</p>  <p>VOLVO 3515093 8141475 BOSCH 0265001187</p>	<p>YEM-H9884</p>  <p>现代 R265-7 4921 597</p>
<p>YEM-H9885</p>  <p>现代 R265-7 4921 599</p>	<p>YEM-H9886</p>  <p>康明斯 5011855AA 4921 601</p>	<p>YEM-H9887</p>  <p>偏心轴转速传感器 3插 PC400-7 6217-81-9210</p>	<p>YEM-H9888</p>  <p>SK350-8 S841-01590 JOBE 偏心轴转速传感器</p>
<p>YEM-H9889</p>  <p>日野 949979-1420 曲轴传感器</p>	<p>YEM-H9890</p>  <p>D04FR SK140-8 曲轴传感器 长线</p>	<p>YEM-H9891</p>  <p>PERKINS 1855-781C91</p>	<p>YEM-H9892</p>  <p>JCB 716/30123</p>
<p>YEM-H9893</p>  <p>238-4676 ZGAO-00651</p>	<p>YEM-H9894</p>  <p>DOOSAN DX260-9</p>	<p>YEM-H9895</p>  <p>DCOSAN DX38C SCANIA</p>	<p>YEM-H9896</p>  <p>DOOSAN DX47D SCANIA</p>

凸轮轴传感器 CAMSHAFT SENSOR

压力传感器 PRESSURE SWITCH

<p>YEM-H9897</p>  <p>SANY三一 1319158 回转凸轮轴传感器</p>	<p>YEM-H9898</p>  <p>洋马 久保田 158557-61720</p>	<p>YEM-H9899</p>  <p>4M50 HD820-5</p>	<p>YEM-H9900</p>  <p>LIEBHERR 利勃海尔</p>
<p>YEM-H9901</p>  <p>五+铃ISUZU 8-12146830-0 进气感应器</p>	<p>YEM-H9902</p>  <p>VOLVO 20450095 温度传感器(OLD)</p>	<p>YEM-H9903</p>  <p>8-97217778-0 HITACHI 进气传感器</p>	<p>YEM-H9904</p>  <p>BOSCH 0281002316 DAF 1398468 1698686 RENAULT 5010412448 CUMMINS 4893924 IVECO 04893924</p>
<p>YEM-H9905</p>  <p>VOLVO 20483889 20514065 20803650 RENAULT 7420514065 7420803650</p>	<p>YEM-H9906</p>  <p>VOLVO 8158821 20428459 20528336 20829689</p>	<p>YEM-H9907</p>  <p>BOSCH 0281002244 0281002245 0261002244 BENZ 0041531828 0041531928</p>	<p>YEM-H9908</p>  <p>BOSCH 0281002468 0041537628 0041537023 BENZ 0041537028</p>
<p>YEM-H9909</p>  <p>VOLVO 20476992 20824479 20449988 MACK 64MT475M 11W347 63038</p>	<p>YEM-H9910</p>  <p>VOLVO 441050080</p>	<p>YEM-H9911</p>  <p>VOLVO EC480 20542128</p>	<p>YEM-H9912</p>  <p>VOLVO 20893503 5线</p>
<p>YEM-H9913</p>  <p>VOLVO 20893503 6线</p>	<p>YEM-H9914</p>  <p>VOLVO 3985226</p>	<p>YEM-H9915</p>  <p>RENAULT 7421059645 7482492420 7421059642 5010480815 VOLVO 20832162 85109590 21116881 21059645 82492420 21059642 3948425</p>	<p>YEM-H9916</p>  <p>VOLVO 3985226S</p>



<p>YEM-H9917</p>  <p>NSK压力开关 4353686</p>	<p>YEM-H9918</p>  <p>NSK压力开关 4436535</p>	<p>YEM-H9919</p>  <p>NSK压力开关 4436536</p>	<p>YEM-H9920</p>  <p>NSK压力开关 CAT D型大方</p>
<p>YEM-H9921</p>  <p>NSK压力开关 CAT D型小方</p>	<p>YEM-H9922</p>  <p>NSK压力开关 CAT 大方</p>	<p>YEM-H9923</p>  <p>NSK压力开关 CAT 大圆</p>	<p>YEM-H9924</p>  <p>NSK压力开关 CAT 小方</p>
<p>YEM-H9925</p>  <p>NSK压力开关 CAT 小圆</p>	<p>YEM-H9926</p>  <p>NSK压力开关 CAT 液压传感器 大圆</p>	<p>YEM-H9927</p>  <p>NSK压力开关 DH粗牙</p>	<p>YEM-H9928</p>  <p>NSK压力开关 DX</p>

压力传感器 PRESSURE SWITCH

压力传感器 PRESSURE SWITCH

<p>YEM-H9929</p>  <p>NSK压力开关 EX绿</p>	<p>YEM-H9930</p>  <p>NSK压力开关 EX细牙</p>	<p>YEM-H9931</p>  <p>NSK压力开关 EX液压传感器</p>	<p>YEM-H9932</p>  <p>NSK压力开关 HD</p>
<p>YEM-H9933</p>  <p>NSK压力开关 PC-5带线</p>	<p>YEM-H9934</p>  <p>NSK压力开关 PC200-6</p>	<p>YEM-H9935</p>  <p>NSK压力开关 PC200-7</p>	<p>YEM-H9936</p>  <p>NSK压力开关 SK带线, 徐工</p>
<p>YEM-H9937</p>  <p>NSK压力开关 现代981-2</p>	<p>YEM-H9938</p>  <p>PC400-8 208-06-71140</p>	<p>YEM-H9939</p>  <p>PC400-8 208-06-71130</p>	<p>YEM-H9940</p>  <p>传感器114-5333</p>
<p>YEM-H9941</p>  <p>传感器 167-1709</p>	<p>YEM-H9942</p>  <p>压力传感器 173-7252</p>	<p>YEM-H9943</p>  <p>压力传感器 E320</p>	<p>YEM-H9944</p>  <p>压力传感器 卡特 CATGC</p>
<p>YEM-H9945</p>  <p>DX DOOSAN 301413-00287</p>	<p>YEM-H9946</p>  <p>机油传感器 CAT320D 453-5523-02</p>	<p>YEM-H9947</p>  <p>CAT 305-6873</p>	<p>YEM-H9948</p>  <p>320-3061</p>

<p>YEM-H9949</p>  <p>CAT 161-9926</p>	<p>YEM-H9950</p>  <p>349-7378</p>	<p>YEM-H9951</p>  <p>320-3063</p>	<p>YEM-H9952</p>  <p>压力传感器RE542461-2011C</p>
<p>YEM-H9953</p>  <p>52CP34-03</p>	<p>YEM-H9954</p>  <p>DX DOOSAN</p>	<p>YEM-H9955</p>  <p>244-3106</p>	<p>YEM-H9956</p>  <p>ZAX200-5G 4703324</p>
<p>YEM-H9957</p>  <p>KM16-5YC 7247998</p>	<p>YEM-H9958</p>  <p>大宇 DX85PP78-01</p>	<p>YEM-H9959</p>  <p>31Q8-40510</p>	<p>YEM-H9960</p>  <p>VOLVO 17216318</p>
<p>YEM-H9961</p>  <p>VOLVO 2094364</p>	<p>YEM-H9962</p>  <p>VOLVO 17202579</p>	<p>YEM-H9963</p>  <p>VOLVO 17271141</p>	<p>YEM-H9964</p>  <p>三一-SANY 高压</p>
<p>YEM-H9965</p>  <p>三-SANY 低压 KM25-E32</p>	<p>YEM-H9966</p>  <p>三一 低压0420641-5MPa</p>	<p>YEM-H9967</p>  <p>中联 三一 柳工</p>	<p>YEM-H9968</p>  <p>龙工</p>

压力传感器 PRESSURE SWITCH

进气压力传感器 AIR PRESSURE SENSOR

<p>YEM-H9969</p>  <p>7861-93-1620</p>	<p>YEM-H9970</p>  <p>龙工223-16-0072低压60Bar</p>	<p>YEM-H9971</p>  <p>龙工 低压50Bar</p>	<p>YEM-H9972</p>  <p>龙工 高压500Bar</p>
<p>YEM-H9973</p>  <p>徐工高压 13牙 小螺纹 LC-XCMG-3-4-500Bar</p>	<p>YEM-H9974</p>  <p>徐工高压 16牙 大螺纹 LC-XCMG-500Bar</p>	<p>YEM-H9975</p>  <p>徐工低压/原装16.5牙 大螺纹 LC-XCMG-3-4-2050Bar</p>	<p>YEM-H9976</p>  <p>龙工 063G1801</p>
<p>YEM-H9977</p>  <p>龙工063G1802</p>	<p>YEM-H9978</p>  <p>雷沃</p>	<p>YEM-H9979</p>  <p>PC3000 600Bar</p>	<p>YEM-H9980</p>  <p>CAT 400Bar</p>
<p>YEM-H9981</p>  <p>6D140 3330600</p>	<p>YEM-H9982</p>  <p>6D140 3347907 6560-41-6100</p>	<p>YEM-H9983</p>  <p>6D170 3408587 6560-61-7102</p>	<p>YEM-H9984</p>  <p>6131 J05 J08 15P23198</p>
<p>YEM-H9985</p>  <p>ZAX200-3 15P23386</p>	<p>YEM-H9986</p>  <p>6340 A20N09B</p>	<p>YEM-H9987</p>  <p>DX480-9C</p>	<p>YEM-H9988</p>  <p>卡特E系列</p>

<p>YEM-H9989</p>  <p>VOLVO 20715967 20893518 21116880</p>	<p>YEM-H9990</p>  <p>CAT312D 266-0126 进气压力传感器</p>	<p>YEM-H9991</p>  <p>VOLVO 21442662 进气压力传感器</p>	<p>YEM-H9992</p>  <p>VOLVO 21304786 22181342</p>
<p>YEM-H9993</p>  <p>107-8618 进气湿度传感器</p>	<p>YEM-H9994</p>  <p>空气压力感应器 AIR PRESSURE SENSOR</p>	<p>YEM-H9995</p>  <p>空气压力感应器 AIR PRESSURE SENSOR</p>	<p>YEM-H9996</p>  <p>CAT 381-9064</p>
<p>YEM-H9997</p>  <p>PC200-8 PRESSURE SWITCH</p>	<p>YEM-H9998</p>  <p>PC200-7空气报警器</p>	<p>YEM-H9999</p>  <p>6261-81-26000</p>	<p>YEM-H10000</p>  <p>卡特</p>
<p>YEM-H10001</p>  <p>卡特</p>	<p>YEM-H10002</p>  <p>卡特</p>	<p>YEM-H10003</p>  <p>卡特</p>	<p>YEM-H10004</p>  <p>卡特</p>
<p>YEM-H10005</p>  <p>卡特 9X9643</p>	<p>YEM-H10006</p>  <p>卡特</p>	<p>YEM-H10007</p>  <p>卡特</p>	<p>YEM-H10008</p>  <p>卡特</p>





















进气压力传感器 AIR PRESSURE SENSOR

机油感应器 OIL PRESSURE SWITCH

<p>YEM-H10009</p>  <p>卡特131-4135</p>	<p>YEM-H10010</p>  <p>卡特</p>	<p>YEM-H10011</p>  <p>卡特174-4312</p>	<p>YEM-H10012</p>  <p>卡特</p>
<p>YEM-H10013</p>  <p>卡特</p>	<p>YEM-H10014</p>  <p>卡特136-2632</p>	<p>YEM-H10015</p>  <p>卡特</p>	<p>YEM-H10016</p>  <p>小松421-06-3511</p>
<p>YEM-H10017</p>  <p>卡特</p>	<p>YEM-H10018</p>  <p>卡特</p>	<p>YEM-H10019</p>  <p>卡特</p>	<p>YEM-H10020</p>  <p>压差传感器 康明斯 1MPP2-1 玉柴</p>
<p>YEM-H10021</p>  <p>大气压力传感器 SK200-8 ZAX200-3 E320C VH893901080A</p>	<p>YEM-H10022</p>  <p>ISUZU ZAX490-5A 6UZI 8-98121697-0</p>	<p>YEM-H10023</p>  <p>ISUZU 8-98065377-0</p>	<p>YEM-H10024</p>  <p>斗山 SOOSAN 0261230112</p>
<p>YEM-H10025</p>  <p>康明斯 4902720</p>	<p>YEM-H10026</p>  <p>SK210-10 大气压力传感器</p>	<p>YEM-H10027</p>  <p>约翰迪尔</p>	<p>YEM-H10028</p>  <p>PC400-8 6261-81-2700</p>

<p>YEM-H10029</p>  <p>卡特 CAT 3116 131-9203</p>	<p>YEM-H10030</p>  <p>卡特459-2594 459-2597</p>	<p>YEM-H10031</p>  <p>459-2595</p>	<p>YEM-H10032</p>  <p>CAT 107-0612</p>
<p>YEM-H10033</p>  <p>CAT 107-0613</p>	<p>YEM-H10034</p>  <p>CAT 铲车机油压力传感器 3408E 3208E 107-0614</p>	<p>YEM-H10035</p>  <p>卡特 CAT 313-5104</p>	<p>YEM-H10036</p>  <p>327-4608</p>
<p>YEM-H10037</p>  <p>CAT 202-9002压力传感器</p>	<p>YEM-H10038</p>  <p>PC450-7 4921517</p>	<p>YEM-H10039</p>  <p>DEUTZ VOLVO 240(老款)</p>	<p>YEM-H10040</p>  <p>11039575</p>
<p>YEM-H10041</p>  <p>VOLVO 3962894</p>	<p>YEM-H10042</p>  <p>VOLVO 11038812 11039574 15047336 MACK 14W355 63038</p>	<p>YEM-H10043</p>  <p>VOLVO 20424051 3963471 70495157</p>	<p>YEM-H10044</p>  <p>VOLVO 21634021 机油感应塞 OIL SENSOR</p>
<p>YEM-H10045</p>  <p>VOLVO460 22899626 机油感应塞 OIL SENSOR</p>	<p>YEM-H10046</p>  <p>VOLVO 机油感应塞 OIL SENSOR</p>	<p>YEM-H10047</p>  <p>VOLVO 034774 2132639/20484678</p>	<p>YEM-H10048</p>  <p>VOLVO 11039574</p>

机油感应器 OIL PRESSURE SWITCH



<p>YEM-H10049</p>  <p>VOLVO 480-1077574 机油感应塞 OILSENSOR</p>	<p>YEM-H10050</p>  <p>VOLV021634017 OIL PRESSURE SENSOR</p>	<p>YEM-H10051</p>  <p>2033392 2127357</p>	<p>YEM-H10052</p>  <p>VOLVO 20928532 20442606 68326728</p>
<p>YEM-H10053</p>  <p>VOLVO 20928533 68326729 3986607 20392985 20442608</p>	<p>YEM-H10054</p>  <p>VOLVO 20526767 20928541</p>	<p>YEM-H10055</p>  <p>VOLVO 20928544 21390375 20526768</p>	<p>YEM-H10056</p>  <p>VOLVO 11170072</p>
<p>YEM-H10057</p>  <p>VOLVO 11170071</p>	<p>YEM-H10058</p>  <p>VOLVO 11170090</p>	<p>YEM-H10059</p>  <p>VOLVO 11170075</p>	<p>YEM-H10060</p>  <p>VOLVO 11170079 11170076</p>
<p>YEM-H10061</p>  <p>11038813</p>	<p>YEM-H10062</p>  <p>VOLVO 11039549 21302639 15163008 11170259 11039721</p>	<p>YEM-H10063</p>  <p>VOLVO11039577</p>	<p>YEM-H10064</p>  <p>1771230</p>
<p>YEM-H10065</p>  <p>11418080</p>	<p>YEM-H10066</p>  <p>11039557</p>	<p>YEM-H10067</p>  <p>VOLVO</p>	<p>YEM-H10068</p>  <p>780941</p>

机油感应器 OIL PRESSURE SWITCH

<p>YEM-H10069</p>  <p>15180002</p>	<p>YEM-H10070</p>  <p>11039557 1008100096 柳工 NEW 机油感应塞</p>	<p>YEM-H10071</p>  <p>5090257</p>	<p>YEM-H10072</p>  <p>11039662</p>
<p>YEM-H10073</p>  <p>VOLVO 11419327</p>	<p>YEM-H10074</p>  <p>VOLVO 11039376</p>	<p>YEM-H10075</p>  <p>柳工机油压力 34B1008 100096 34Bar</p>	<p>YEM-H10076</p>  <p>柳工机油压力 30B0897 10096</p>
<p>YEM-H10077</p>  <p>10316 523144 11Bar</p>	<p>YEM-H10078</p>  <p>柳工18003017530 1.5Bar 2.0Bar</p>	<p>YEM-H10079</p>  <p>徐工 Zmpar101103</p>	<p>YEM-H10080</p>  <p>P165-5183</p>
<p>YEM-H10081</p>  <p>HYUNDAI 31NA-20080</p>	<p>YEM-H10082</p>  <p>机油压力传感器 康明斯 山重/三一-B240600000286</p>	<p>YEM-H10083</p>  <p>玉柴 机油感应塞</p>	<p>YEM-H10084</p>  <p>康明斯</p>
<p>YEM-H10085</p>  <p>3015237S</p>	<p>YEM-H10086</p>  <p>VDO 360081051003 360081051003C Volvo 8125160 1594229</p>	<p>YEM-H10087</p>  <p>Volvo 622333</p>	<p>YEM-H10088</p>  <p>Volvo 20927970 1347010</p>

机油感应器 OIL PRESSURE SWITCH

机油感应器 OIL PRESSURE SWITCH

<p>YEM-H10089</p>  <p>墨菲单脚</p>	<p>YEM-H10090</p>  <p>墨菲双脚</p>	<p>YEM-H10091</p>  <p>PC200-8 6040 低压</p>	<p>YEM-H10092</p>  <p>PC200-8 5545 NEW 663-5545 421-43-22912</p>
<p>YEM-H10093</p>  <p>PC200-8 4537 9Y2-4537 421-43-22922</p>	<p>YEM-H10094</p>  <p>PC200-8771-1409 低压</p>	<p>YEM-H10095</p>  <p>机油传感器 DH80 DX80</p>	<p>YEM-H10096</p>  <p>VOLVO 11039617</p>
<p>YEM-H10097</p>  <p>柳工 36118-064530</p>	<p>YEM-H10098</p>  <p>大字 30143-00151</p>	<p>YEM-H10099</p>  <p>13617-433026</p>	<p>YEM-H10100</p>  <p>柳工 10213169</p>
<p>YEM-H10101</p>  <p>20316 26877</p>	<p>YEM-H10102</p>  <p>06912019</p>	<p>YEM-H10103</p>  <p>32216 142011</p>	<p>YEM-H10104</p>  <p>09812 682</p>
<p>YEM-H10105</p>  <p>3451 310</p>	<p>YEM-H10106</p>  <p>01818 201005</p>	<p>YEM-H10107</p>  <p>龙工 OilSensor</p>	<p>YEM-H10108</p>  <p>VOLVO360 24424110</p>

<p>YEM-H10109</p>  <p>PC350-10 4984590 进气流量传感器</p>	<p>YEM-H10110</p>  <p>VOLVO 20382529 8155754</p>	<p>YEM-H10111</p>  <p>CAT 266-1466</p>	<p>YEM-H10112</p>  <p>266-1467</p>
<p>YEM-H10113</p>  <p>266-1475</p>	<p>YEM-H10114</p>  <p>266-1477</p>	<p>YEM-H10115</p>  <p>266-1478</p>	<p>YEM-H10116</p>  <p>266-1481</p>
<p>YEM-H10117</p>  <p>266-2337</p>	<p>YEM-H10118</p>  <p>266-1484</p>	<p>YEM-H10119</p>  <p>266-1492</p>	<p>YEM-H10120</p>  <p>8-98086433-0五十铃传感器</p>
<p>YEM-H10121</p>  <p>机油传感器 OIL SENSOR</p>	<p>YEM-H10122</p>  <p>机油传感器 OIL SENSOR</p>	<p>YEM-H10123</p>  <p>SK230-6 机油感应器 OIL PRESSURE SWITCH</p>	<p>YEM-H10124</p>  <p>空气压力开关 4M50 MD176361</p>
<p>YEM-H10125</p>  <p>卡特 131-4135</p>	<p>YEM-H10126</p>  <p>卡特 136-2632</p>	<p>YEM-H10127</p>  <p>卡特 440-0257 D29M12Y21P475</p>	<p>YEM-H10128</p>  <p>卡特 174-4312</p>

水温感应器 WATER TEMP SENSOR

水温感应器 WATER TEMP SENSOR

























<p>YEM-H10129</p>  <p>E312D(螺牙18)</p>	<p>YEM-H10130</p>  <p>水温感应器 203-3219</p>	<p>YEM-H10131</p>  <p>水温传感器 E311C 341-3600</p>	<p>YEM-H10132</p>  <p>CAT 水温感应器</p>
<p>YEM-H10133</p>  <p>CAT 244-3106</p>	<p>YEM-H10134</p>  <p>E320D 2848A127 帕金斯 PERKINS</p>	<p>YEM-H10135</p>  <p>2848A12</p>	<p>YEM-H10136</p>  <p>203-3221</p>
<p>YEM-H10137</p>  <p>7N9560</p>	<p>YEM-H10138</p>  <p>2848A071 237-4894 帕金斯 PERKINS</p>	<p>YEM-H10139</p>  <p>385720510 帕金斯 PERKINS</p>	<p>YEM-H10140</p>  <p>PERKINS 185246290 帕金斯机油传感器</p>
<p>YEM-H10141</p>  <p>PERKINS 2848A126 帕金斯柴油机温度开关</p>	<p>YEM-H10142</p>  <p>185246280 帕金斯 PERKINS</p>	<p>YEM-H10143</p>  <p>PERKINS 2848A129 帕金斯温度传感器</p>	<p>YEM-H10144</p>  <p>PC小松 08620-0000 水温感应器</p>
<p>YEM-H10145</p>  <p>PC600-8 6D140 6D170 6560-61-7300</p>	<p>YEM-H10146</p>  <p>五十铃 W4500 8-97078592-9水温感应器</p>	<p>YEM-H10147</p>  <p>水温报警器 ZAX电喷</p>	<p>YEM-H10148</p>  <p>SH200A3 KHR2433 3DA1223 179730-0040</p>

<p>YEM-H10149</p>  <p>水温报警器 SK</p>	<p>YEM-H10150</p>  <p>水温传感器 SK130-8 D04FR 32G90-00201</p>	<p>YEM-H10151</p>  <p>J05E 4HK1 高压柴油泵油温传感器</p>	<p>YEM-H10152</p>  <p>366869 4M40 CAT307 水温感应器</p>
<p>YEM-H10153</p>  <p>洋马 YANMAR(双脚) 水温感应器</p>	<p>YEM-H10154</p>  <p>洋马 YANMAR 水温感应器</p>	<p>YEM-H10155</p>  <p>洋马 YANMAR 水温感应器</p>	<p>YEM-H10156</p>  <p>VOLVO 1612230 1594225</p>
<p>YEM-H10157</p>  <p>VOLVO 20429956 20576617 RENAULT 7420576617</p>	<p>YEM-H10158</p>  <p>VOLVO 1611153</p>	<p>YEM-H10159</p>  <p>BENZ 7401594228 MAN 1594228</p>	<p>YEM-H10160</p>  <p>VOLVO 15048183/11144494 水温感应器</p>
<p>YEM-H10161</p>  <p>VOLVO360 205-76614 水温感应器</p>	<p>YEM-H10162</p>  <p>VOLVO 20429956</p>	<p>YEM-H10163</p>  <p>VOLVO 2096397</p>	<p>YEM-H10164</p>  <p>VOLVO 15153124</p>
<p>YEM-H10165</p>  <p>HYU NDAI 21EA-62010 R60-7 水温感应器</p>	<p>YEM-H10166</p>  <p>4921477</p>	<p>YEM-H10167</p>  <p>柳工 205/225温度传感器 WG2704G 30B0260</p>	<p>YEM-H10168</p>  <p>水温感应器 OEM:3015238</p>

水温感应器 WATER TEMP SENSOR

水温感应器 WATER TEMP SENSOR

<p>YEM-H10169</p>  <p>水温传感器 柳工 30B0316</p>	<p>YEM-H10170</p>  <p>水温传感器 柳工30B0252</p>	<p>YEM-H10171</p>  <p>水温感应塞 柳工90630B0409</p>	<p>YEM-H10172</p>  <p>水温传感器 柳工906C 30B0289</p>
<p>YEM-H10173</p>  <p>水温传感器 柳工908C/20030B0260</p>	<p>YEM-H10174</p>  <p>水温传感器 柳工30B0321</p>	<p>YEM-H10175</p>  <p>柳工205/225 温度传感器/带线 WGP3343 30B0322</p>	<p>YEM-H10176</p>  <p>温度传感器 柳工230B0400</p>
<p>YEM-H10177</p>  <p>液压油温传感器 柳工30B0264</p>	<p>YEM-H10178</p>  <p>油温度传感器 30B0322</p>	<p>YEM-H10179</p>  <p>油温度传感器 中联</p>	<p>YEM-H10180</p>  <p>水温传感器 石川岛 JET00015</p>
<p>YEM-H10181</p>  <p>4327021</p>	<p>YEM-H10182</p>  <p>3408627</p>	<p>YEM-H10183</p>  <p>水温传感器 徐工150 XE150-001</p>	<p>YEM-H10184</p>  <p>水温传感器 龙工小挖 JETO0018</p>
<p>YEM-H10185</p>  <p>温度传感器 国机重工235/255 14NPTF-M22X1.5</p>	<p>YEM-H10186</p>  <p>温度开关 30B0271</p>	<p>YEM-H10187</p>  <p>三-SANY温度传感器</p>	<p>YEM-H10188</p>  <p>SUMITOMO 住友液压感应器</p>

<p>YEM-H10189</p>  <p>3E5370 3116</p>	<p>YEM-H10190</p>  <p>102-3190 102-0050</p>	<p>YEM-H10191</p>  <p>CAT 131-0427</p>	<p>YEM-H10192</p>  <p>CAT 130-8299</p>
<p>YEM-H10193</p>  <p>CAT 371-9531</p>	<p>YEM-H10194</p>  <p>CAT 102-2240</p>	<p>YEM-H10195</p>  <p>195-2150</p>	<p>YEM-H10196</p>  <p>CAT 145-7028</p>
<p>YEM-H10197</p>  <p>机油油温传感器 CAT 191-6587</p>	<p>YEM-H10198</p>  <p>CAT 106-0735</p>	<p>YEM-H10199</p>  <p>CAT108-3190</p>	<p>YEM-H10200</p>  <p>CAT 171-8708</p>
<p>YEM-H10201</p>  <p>118-7226 3508</p>	<p>YEM-H10202</p>  <p>CAT 3E-8700</p>	<p>YEM-H10203</p>  <p>CAT 100-3055</p>	<p>YEM-H10204</p>  <p>CAT 134-2252</p>
<p>YEM-H10205</p>  <p>CAT 131-0784</p>	<p>YEM-H10206</p>  <p>3E-5370</p>	<p>YEM-H10207</p>  <p>CAT 430-9449</p>	<p>YEM-H10208</p>  <p>CAT 430-9451</p>
<p>YEM-H10209</p>  <p>CAT 130-9811</p>	<p>YEM-H10210</p>  <p>神钢KOBELCO</p>	<p>YEM-H10211</p>  <p>徐工 239-9957 4903489</p>	<p>YEM-H10212</p>  <p>徐工</p>

水温感应器 WATER TEMP SENSOR

水温感应器 WATER TEMP SENSOR

<p>YEM-H10213</p>  <p>徐工470D</p>	<p>YEM-H10214</p>  <p>徐工 大螺丝</p>	<p>YEM-H10215</p>  <p>康明斯4383933</p>	<p>YEM-H10216</p>  <p>水温传感器178-2334-00</p>
<p>YEM-H10217</p>  <p>E320C/330C 178-2335</p>	<p>YEM-H10218</p>  <p>JOHN DEERE</p>	<p>YEM-H10219</p>  <p>SCANIA DX470</p>	<p>YEM-H10220</p>  <p>2479R546</p>
<p>YEM-H10221</p>  <p>DEUTZ 01182700</p>	<p>YEM-H10222</p>  <p>五十铃 8-98156648-0</p>	<p>YEM-H10223</p>  <p>SK130-8</p>	<p>YEM-H10224</p>  <p>小松装载机 232-06-52410</p>
<p>YEM-H10225</p>  <p>订做款</p>	<p>YEM-H10226</p>  <p>8-97063301-04LE2</p>	<p>YEM-H10227</p>  <p>久保田</p>	<p>YEM-H10228</p>  <p>QM11 3085185X空气温度传感器</p>
<p>YEM-H10229</p>  <p>水温传感器 约翰迪尔 RE516336</p>	<p>YEM-H10230</p>  <p>水温传感器 约翰迪尔 RE52722</p>	<p>YEM-H10231</p>  <p>水温传感器 约翰迪尔 RE51774</p>	<p>YEM-H10232</p>  <p>水温传感器</p>
<p>YEM-H10233</p>  <p>3865312</p>	<p>YEM-H10234</p>  <p>4921511</p>	<p>YEM-H10235</p>  <p>4921487</p>	<p>YEM-H10236</p>  <p>4921501</p>

<p>YEM-H10237</p>  <p>4928594</p>	<p>YEM-H10238</p>  <p>4921503</p>	<p>YEM-H10239</p>  <p>2897690</p>	<p>YEM-H10240</p>  <p>4921519</p>
<p>YEM-H10241</p>  <p>4921489</p>	<p>YEM-H10242</p>  <p>4921495</p>	<p>YEM-H10243</p>  <p>3408607</p>	<p>YEM-H10244</p>  <p>23527829</p>
<p>YEM-H10245</p>  <p>23527828</p>	<p>YEM-H10246</p>  <p>4921505</p>	<p>YEM-H10247</p>  <p>4921499</p>	<p>YEM-H10248</p>  <p>4928593</p>
<p>YEM-H10249</p>  <p>4921519</p>	<p>YEM-H10250</p>  <p>4921493</p>	<p>YEM-H10251</p>  <p>JCB 716/24200</p>	<p>YEM-H10252</p>  <p>JCB 716/12800</p>
<p>YEM-H10253</p>  <p>JCB 701/37400</p>	<p>YEM-H10254</p>  <p>JCB 701/43700</p>	<p>YEM-H10255</p>  <p>JCB 701/80591</p>	<p>YEM-H10256</p>  <p>JCB 701/41700</p>
<p>YEM-H10257</p>  <p>JCB 701/80225</p>	<p>YEM-H10258</p>  <p>JCB 320/04046</p>	<p>YEM-H10259</p>  <p>JCB 701/41600</p>	<p>YEM-H10260</p>  <p>JCB 320/04588</p>

水温感应器 WATER TEMP SENSOR

电磁阀线圈 SOLENOID VALVE COIL

<p>YEM-H10261</p>  <p>JCB 332/J2973</p>	<p>YEM-H10262</p>  <p>PC220-8/220/240-8 600-311-3721 油水分离器传感器</p>	<p>YEM-H10263</p>  <p>CAT320D 3针 423-66434-01</p>	<p>YEM-H10264</p>  <p>CAT336D 4针 382-2001</p>
<p>YEM-H10265</p>  <p>VOLVO 360</p>	<p>YEM-H10266</p>  <p>VOLVO</p>	<p>YEM-H10267</p>  <p>CAT 439-5039</p>	<p>YEM-H10268</p>  <p>117-4089玻璃杯传感器</p>
<p>YEM-H10269</p>  <p>FS1242玻璃杯传感器</p>	<p>YEM-H10270</p>  <p>FS1242 R120P R90P 通用玻璃杯传感器</p>	<p>YEM-H10271</p>  <p>玉柴两管</p>	<p>YEM-H10272</p>  <p>水位传感器 山重 J213-04A-041000</p>
<p>YEM-H10273</p>  <p>柳工水位传感器</p>	<p>YEM-H10274</p>  <p>日立油水传感器 ZAX200/210/240</p>	<p>YEM-H10275</p>  <p>VOLVO EC360 水位传感器</p>	<p>YEM-H10276</p>  <p>VOLVO 210B 水位传感器</p>
<p>YEM-H10277</p>  <p>临工VOLVO210D</p>	<p>YEM-H10278</p>  <p>VOLVO VOE14541720</p>	<p>YEM-H10279</p>  <p>PC WA380-3 小插</p>	<p>YEM-H10280</p>  <p>PCWA470-3 7861-92-4500 大插</p>
<p>YEM-H10281</p>  <p>7861-93-4520</p>	<p>YEM-H10282</p>  <p>CAT295-3099</p>	<p>YEM-H10283</p>  <p>VOLVO 21285163</p>	<p>YEM-H10284</p>  <p>氢传感器 L33C-18-8G1</p>
<p>YEM-H10285</p>  <p>CAT 418-6597</p>			

<p>YEM-H10286</p>  <p>电磁阀线圈 厦工808 4301864 3411</p>	<p>YEM-H10287</p>  <p>PC 714-11-16840 714-11-16830</p>	<p>YEM-H10288</p>  <p>行走电磁阀线圈 PC60-5/6</p>	<p>YEM-H10289</p>  <p>DH220-512V</p>
<p>YEM-H10290</p>  <p>DH220-5/13大 24V</p>	<p>YEM-H10291</p>  <p>柳工</p>	<p>YEM-H10292</p>  <p>VOLVO210 NEW总成</p>	<p>YEM-H10293</p>  <p>VOLVO 360/460B 17W/27W</p>
<p>YEM-H10294</p>  <p>VOLVO</p>	<p>YEM-H10295</p>  <p>CAT 312-4288</p>	<p>YEM-H10296</p>  <p>H:49.5mm Φ19/22mm 936-6171 12V 龙工</p>	<p>YEM-H10297</p>  <p>厦工815/822/825/836</p>
<p>YEM-H10298</p>  <p>派克 PARKER</p>	<p>YEM-H10299</p>  <p>CAT E336D</p>	<p>YEM-H10300</p>  <p>徐工 NEW</p>	<p>YEM-H10301</p>  <p>徐工 NEW</p>
<p>YEM-H10302</p>  <p>300AA00082A</p>	<p>YEM-H10303</p>  <p>CAT186-1525 321-5658</p>	<p>YEM-H10304</p>  <p>186-1526 301-3118</p>	<p>YEM-H10305</p>  <p>CAT</p>
<p>YEM-H10306</p>  <p>CAT C9</p>			
<p>YEM-H10307</p>  <p>H:50mm Φ20mm E330D/336/345/349</p>	<p>YEM-H10308</p>  <p>H:50mm Φ20mm E330D/336/345/349 无线</p>	<p>YEM-H10309</p>  <p>卡特 徐工 中联 力士乐</p>	<p>YEM-H10310</p>  <p>H:53mm Φ14mm 住友SHA1/A2</p>
<p>YEM-H10311</p> <p>DX60</p>			

电磁阀芯 SOLENOID VALVE CORE

继电器系列 STARTER RELAY

YEM-H10312  徐工3排	YEM-H10313  电磁阀阀芯 φ20	YEM-H10314  SH200A3 DH55 DH60	YEM-H10315  徐工470/490
YEM-H10316  徐工	YEM-H10317  厦工柳工山河智能	YEM-H10318  柳工厦工山河智能	YEM-H10319  中联短款
YEM-H10320  中联长款	YEM-H10321  厦工808	YEM-H10322  R225-7	YEM-H10323  EC140 轮挖长款
YEM-H10324  CAT	YEM-H10325  VOLVO R 短款	YEM-H10326  三一 SANY55	YEM-H10327  DH300
YEM-H10328  R110VS R150VS	YEM-H10329  ZAX200 大孔	YEM-H10330  ZAX200 小孔	YEM-H10331  25/103000
YEM-H10332  EC210/240/290	YEM-H10333  VOLVO 装载机	YEM-H10334  PC120-6小孔	YEM-H10335  PC120-6大孔

YEM-H10336  CAT E320C 176810-0050	YEM-H10337  056800-3130 24V	YEM-H10338  ACA1223-2 41223	YEM-H10339  时间继电器 CAT320B 111-4870
YEM-H10340  雨刮继电器 SK200-6大灯	YEM-H10341  空调继电器CAT 213-0772	YEM-H10342  空调继电器 E330D 461-6784	YEM-H10343  CAT 12V/24V 通用款继电器
YEM-H10344  继电器CAT 171-2210	YEM-H10345  继电器 CAT 138-5190X 12V/24V	YEM-H10346  继电器 E312 16A11-17001 12/24V	YEM-H10347  E307 ME409675 12/24V
YEM-H10348  DX 100-1248-17-00E-1 100-1233-55-03-B	YEM-H10349  雨刮继电器 CAT E320D	YEM-H10350  ISUZU 182550-3250	YEM-H10351  ISUZU 182550-3251
YEM-H10352  21Q6-30300	YEM-H10353  21M9-31100 12V	YEM-H10354  VOLVO 20724977	YEM-H10355  洋马 Y1752V183

继电器系列 STARTER RELAY

继电器系列 STARTER RELAY

<p>YEM-H10356</p>  <p>177300-8892 20Y-810-123</p>	<p>YEM-H10357</p>  <p>113900-730</p>	<p>YEM-H10358</p>  <p>康明斯 发电机组</p>	<p>YEM-H10359</p>  <p>350-003604 24V</p>
<p>YEM-H10360</p>  <p>柳工 JQX100-12AC</p>	<p>YEM-H10361</p>  <p>柳工 JQX200-24AC</p>	<p>YEM-H10362</p>  <p>预热开关 PC200-8 600-815-2170</p>	<p>YEM-H10363</p>  <p>柳工继电器</p>
<p>YEM-H10364</p>  <p>继电器 三菱</p>	<p>YEM-H10365</p>  <p>继电器/推土机用 PC300-5 7700-85-8327</p>	<p>YEM-H10366</p>  <p>DOOSAN 12V</p>	<p>YEM-H10367</p>  <p>继电器 DOOSAN 24V</p>
<p>YEM-H10368</p>  <p>CAT E336D C9 241-8368 12/24V</p>	<p>YEM-H10369</p>  <p>继电器 三菱</p>	<p>YEM-H10370</p>  <p>259-527424V</p>	<p>YEM-H10371</p> 
<p>YEM-H10372</p>  <p>3050692</p>	<p>YEM-H10373</p>  <p>VOLVO 14531201</p>	<p>YEM-H10374</p>  <p>E320D2</p>	<p>YEM-H10375</p>  <p>CAT</p>

<p>YEM-H10376</p>  <p>CAT E312</p>	<p>YEM-H10377</p>  <p>现代R 21Q4-20100</p>	<p>YEM-H10378</p>  <p>VOLVO 14529298</p>	<p>YEM-H10379</p>  <p>久保田 洋马 15531-64603 6线</p>
<p>YEM-H10380</p>  <p>洋马 YM119640-77711 7线</p>	<p>YEM-H10381</p>  <p>JOHN M70121</p>	<p>YEM-H10382</p>  <p>现代R21FQ-60070</p>	<p>YEM-H10383</p>  <p>YC0027 YC0028</p>
<p>YEM-H10384</p>  <p>油门控制器</p>	<p>YEM-H10385</p>  <p>发动机调节器 VOLVO</p>	<p>YEM-H10386</p>  <p>继电器RELAY KOMATSU 小松</p>	<p>YEM-H10387</p>  <p>大蜗牛 双音喇叭</p>
<p>YEM-H10388</p>  <p>倒车报警器/圆 14X-06-11130</p>	<p>YEM-H10389</p>  <p>CAT 415-06-22100 12V/24V</p>	<p>YEM-H10390</p>  <p>喇叭 Trumpet/Horn</p>	<p>YEM-H10391</p>  <p>喇叭 Trumpet/Horn</p>
<p>YEM-H10392</p>  <p>点烟器 12V/24V</p>	<p>YEM-H10393</p>  <p>910H22</p>	<p>YEM-H10394</p>  <p>KOMATSU WA470-3 417-43-26212</p>	









继电器系列 STARTER RELAY

微动开关 SWITCH ASSY

<p>YEM-H10395</p>  <p>VOLVO 3987034</p>	<p>YEM-H10396</p>  <p>SANY 电源开关</p>	<p>YEM-H10397</p>  <p>21199003 电源开关</p>	<p>YEM-H10398</p>  <p>E320C E312C 电源电磁阀 Solenoid Valve</p>
<p>YEM-H10399</p>  <p>VOLVO 24V KOMATSU 08088-70000</p>	<p>YEM-H10400</p>  <p>DOOSAN 301202-00087</p>	<p>YEM-H10401</p>  <p>DOOSAN MK5543443</p>	<p>YEM-H10402</p>  <p>DOOSAN 301202-00153</p>
<p>YEM-H10403</p>  <p>继电器RELAY CAT卡特 ME049233</p>	<p>YEM-H10404</p>  <p>继电器系列 Starter Relay</p>	<p>YEM-H10405</p>  <p>继电器系列 Starter Relay</p>	<p>YEM-H10406</p>  <p>空调继电器</p>
<p>YEM-H10407</p>  <p>继电器 DOOSAN K1033657</p>	<p>YEM-H10408</p>  <p>继电器 DOOSAN 537-00010</p>	<p>YEM-H10409</p>  <p>继电器 15694-6599212V</p>	<p>YEM-H10410</p>  <p>R-91501-00252 20Q6-50500</p>
<p>YEM-H10411</p>  <p>控制单元 DX12V</p>	<p>YEM-H10412</p>  <p>雨刮控制器 SANY DX-DKF-SZ2 24V</p>	<p>YEM-H10413</p>  <p>雨刮控制器 DKB-SZI 12V</p>	<p>YEM-H10414</p>  <p>CAT104-3204</p>

<p>YEM-H10415</p>  <p>微动开关 R55</p>	<p>YEM-H10416</p>  <p>R60-7 21M8-01400</p>	<p>YEM-H10417</p>  <p>微动开关 R225-7</p>	<p>YEM-H10418</p>  <p>微动开关 225-7</p>
<p>YEM-H10419</p>  <p>22U-06-22360 微动开关 Switch Assy</p>	<p>YEM-H10420</p>  <p>DH225-7 微动开关 Switch Assy</p>	<p>YEM-H10421</p>  <p>DH220-5 微动开关 Switch Ass'y</p>	<p>YEM-H10422</p>  <p>SK220-8 SH 微动开关 Switch Ass'y</p>
<p>YEM-H10423</p>  <p>SK200-8 SWITCH-MICRO</p>	<p>YEM-H10424</p>  <p>山河智能</p>	<p>YEM-H10425</p>  <p>DX300</p>	<p>YEM-H10426</p>  <p>DX55/60</p>
<p>YEM-H10427</p>  <p>力士德</p>	<p>YEM-H10428</p>  <p>玉柴</p>	<p>YEM-H10429</p>  <p>厦工</p>	<p>YEM-H10430</p>  <p>SANY VX-56-1A3</p>
<p>YEM-H10431</p>  <p>VOLVO VOE14502722 SWITCH-MICRO</p>	<p>YEM-H10432</p>  <p>CAT SWITCH-MICRO</p>	<p>YEM-H10433</p>  <p>WA380-3/6 417-43-26221</p>	<p>YEM-H10434</p>  <p>WA470 WA380-3 421-43-26471 421-43-26470</p>

备用开关 SPARE SWITCH











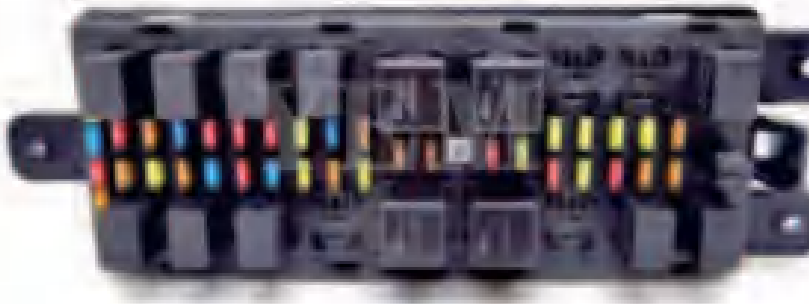









<p>YEM-H10435</p>  <p>2线 备用开关 Square Switch</p>	<p>YEM-H10436</p>  <p>3线 备用开关 Square Switch</p>	<p>YEM-H10437</p>  <p>4线 备用开关 Square Switch</p>	<p>YEM-H10438</p>  <p>6线 备用开关 Square Switch</p>	<p>YEM-H10439</p>  <p>9线 备用开关 Square Switch</p>
<p>YEM-H10440</p>  <p>CAT320B/C12线 备用开关 Square Switch</p>	<p>YEM-H10441</p>  <p>3线 带插 KOBELCO 备用开关 Square Switch</p>	<p>YEM-H10442</p>  <p>HITACHI 4339339</p>	<p>YEM-H10443</p>  <p>PC360-7</p>	<p>YEM-H10444</p>  <p>PC200-7 PC200-8 右控制台应急开关</p>
<p>YEM-H10445</p>  <p>PC200-7 20Y-06-31320</p>	<p>YEM-H10446</p>  <p>VOLVO 2线 14502170</p>	<p>YEM-H10447</p>  <p>VOLVO 4线 14626841</p>	<p>YEM-H10448</p>  <p>VOLVO 6线 14616040</p>	<p>YEM-H10449</p>  <p>VOLVO 12线 14577310</p>
<p>YEM-H10450</p>  <p>CAT 146-0240</p>	<p>YEM-H10451</p>  <p>CAT 165-5970</p>	<p>YEM-H10452</p>  <p>CAT 1-158-6634</p>	<p>YEM-H10453</p>  <p>大字/现代喇叭开关</p>	<p>YEM-H10454</p>  <p>装载机喇叭开关</p>
<p>YEM-H10455</p>  <p>喇叭按钮TRUMPET BUTTON</p>	<p>YEM-H10456</p>  <p>PC200-8 喇叭按钮TRUMPET BUTTON</p>	<p>YEM-H10457</p>  <p>SK200-8 喇叭按钮TRUMPET BUTTON</p>	<p>YEM-H10458</p>  <p>神钢SK130-8 SK140-8</p>	<p>YEM-H10459</p>  <p>PC 大灯开关</p>
<p>YEM-H10460</p>  <p>PC200-7 224-06-22190 蜂鸣开关</p>	<p>YEM-H10461</p>  <p>PC200-7 224-06-22390 大灯开关</p>	<p>YEM-H10462</p>  <p>PC200-7 224-06-22290 回转开关</p>	<p>YEM-H10463</p>  <p>PC200-7 207-06-71180 加力开关</p>	<p>YEM-H10464</p>  <p>LAMP SWITCH</p>

















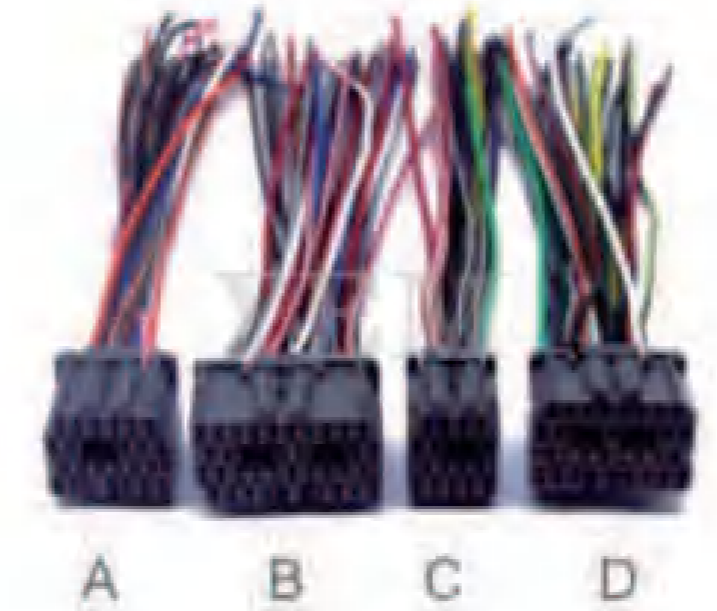

备用开关 SPARE SWITCH

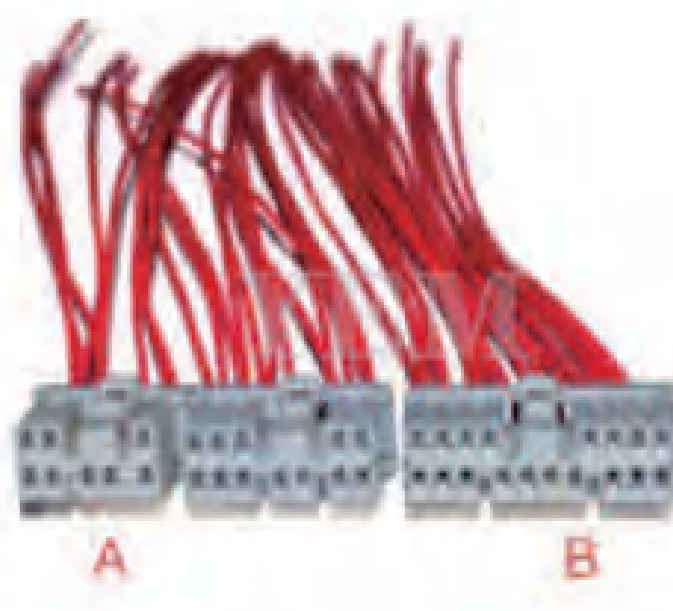
<p>YEM-H10465</p>  <p>PC200-8 20Y-06-42121</p>	<p>YEM-H10466</p>  <p>PC200-8 回转开关</p>	<p>YEM-H10467</p>  <p>HYUNDAI</p>	<p>YEM-H10468</p>  <p>HYUNDAI</p>	<p>YEM-H10469</p>  <p>大灯开关</p>
<p>YEM-H10470</p>  <p>VOLVO 14529227</p>	<p>YEM-H10471</p>  <p>VOLVO 14502010</p>	<p>YEM-H10472</p>  <p>VOLVO 14538729</p>	<p>YEM-H10473</p>  <p>VOLVO 14505609</p>	<p>YEM-H10474</p>  <p>VOLVO 14529183</p>
<p>YEM-H10475</p>  <p>VOLVO 14544028</p>	<p>YEM-H10476</p>  <p>VOLVO 14529185</p>	<p>YEM-H10477</p>  <p>LAMP SWITCH</p>	<p>YEM-H10478</p>  <p>WIPER SWITCH</p>	<p>YEM-H10479</p>  <p>WATER SPRAY SWITCH</p>
<p>YEM-H10480</p>  <p>PC 驻车开关</p>	<p>YEM-H10481</p>  <p>小松KOMATSU</p>	<p>YEM-H10482</p>  <p>大灯开关</p>	<p>YEM-H10483</p>  <p>Head Lamp Switch</p>	<p>YEM-H10484</p>  <p>EC210D EC480D 大灯开关</p>
<p>GB-H10485</p>  <p>VOE14507432</p>		<p>YEM-H10486</p>  <p>70369706/高低速兔子档</p>		<p>YEM-H10487</p>  <p>11428014/雨刮开关</p>

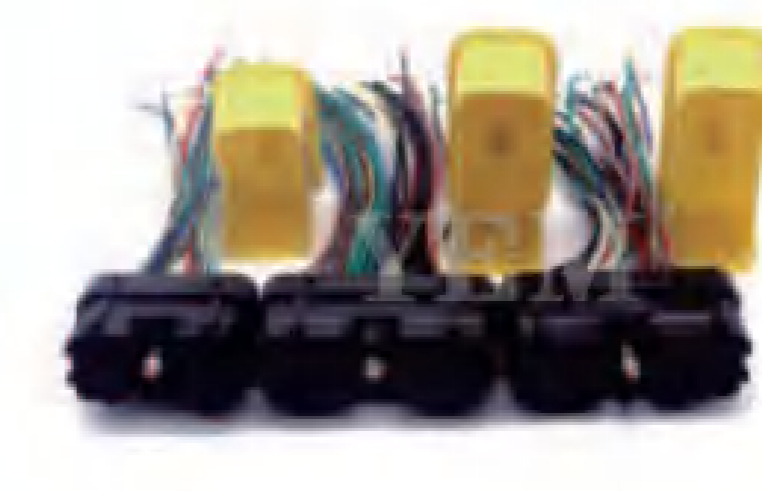



















插头系列 HARNESS SERIES

插头系列 HARNESS SERIES

<p>YEM-H10488</p>  <p>神钢10 SK250-10 保险丝盒</p>	<p>YEM-H10489</p>  <p>现代R 保险丝盒</p>	<p>YEM-H10490</p>  <p>VOLVO EC210D480D 保险丝盒</p>	<p>YEM-H10491</p>  <p>VOLVO EC250D 1472262955 NEW 保险丝盒</p>
<p>YEM-H10492</p>  <p>现代R 保险丝盒</p>	<p>YEM-H10493</p>  <p>日立ZAX-3发动机插头</p>	<p>YEM-H10494</p>  <p>柳工保险丝盒</p>	<p>YEM-H10495</p>  <p>柳工保险丝盒</p>
<p>YEM-H10496</p>  <p>CAT 保险丝盒</p>	<p>YEM-H10497</p>  <p>CAT 保险丝盒</p>	<p>YEM-H10498</p>  <p>大字225-7电脑板插头</p>	<p>YEM-H10499</p>  <p>大字225-7显示屏插头</p>
<p>YEM-H10500</p>  <p>保护器</p>	<p>YEM-H10501</p>  <p>CAT现代</p>	<p>YEM-H10502</p>  <p>洋马 保护器</p>	<p>YEM-H10503</p>  <p>PC300-7保护器</p>
<p>YEM-H10504</p>  <p>插头</p>	<p>YEM-H10505</p>  <p>插头</p>	<p>YEM-H10506</p>  <p>住友电子油泵对插线</p>	<p>YEM-H10507</p>  <p>住友电子油泵线束插头</p>

<p>YEM-H10508</p>  <p>五十铃 94390858</p>	<p>YEM-H10509</p>  <p>SK200-8</p>	<p>YEM-H10510</p>  <p>日野发动机喷嘴 插头总成</p>	<p>YEM-H10511</p>  <p>VOLVO210 MONITOR PLUG</p>
<p>YEM-H10512</p>  <p>PC200-8</p>	<p>YEM-H10513</p>  <p>EX MONITOR PLUG</p>	<p>YEM-H10514</p>  <p>VOLVO(OLD)</p>	<p>YEM-H10515</p>  <p>VOLVO(OLD)</p>
<p>YEM-H10516</p>  <p>SK-6</p>	<p>YEM-H10517</p>  <p>SK-6E</p>	<p>YEM-H10518</p>  <p>SKMONITOR PLUG</p>	<p>YEM-H10519</p>  <p>MONITOR PLUG</p>
<p>YEM-H10520</p>  <p>PC200-7 MONITOR PLUG</p>	<p>YEM-H10521</p>  <p>PC-7</p>	<p>YEM-H10522</p>  <p>VOLVO</p>	<p>YEM-H10523</p>  <p>卡特320B 保险丝盒</p>
<p>YEM-H10524</p>  <p>CAT 2382319</p>	<p>YEM-H10525</p>  <p>E320D 546-5031</p>	<p>YEM-H10526</p>  <p>PC200-8MO</p>	<p>YEM-H10527</p>  <p>CAT 6.4</p>

插头系列 HARNESS SERIES

<p>YEM-H10528</p>  <p>SK</p>	<p>YEM-H10529</p>  <p>PC</p>	<p>YEM-H10530</p>  <p>PC200-8 NIJECTOR PLUG</p>	<p>YEM-H10531</p>  <p>DH BUCKET TEETH PLUG</p>
<p>YEM-H10532</p>  <p>DH BUCKET TEETH PLUG</p>	<p>YEM-H10533</p>  <p>SH STARTER PLUG</p>	<p>YEM-H10534</p>  <p>6D34 ALTERNATOR PLUG</p>	<p>YEM-H10535</p>  <p>6D34 ALTERNATOR PLUG</p>
<p>YEM-H10536</p>  <p>CAT RRESSURE PLUG</p>	<p>YEM-H10537</p>  <p>6D16 FULE PLUG</p>	<p>YEM-H10538</p>  <p>6D16 FULE PLUG</p>	<p>YEM-H10539</p>  <p>SANY</p>
<p>YEM-H10540</p>  <p>DX</p>	<p>YEM-H10541</p>  <p>PC</p>	<p>YEM-H10542</p>  <p>ISUZU</p>	<p>YEM-H10543</p>  <p>SANY</p>
<p>YEM-H10544</p>  <p>PC200-8 6D107</p>	<p>YEM-H10545</p>  <p>PC300-8 6D140 PC600-8 6217-81-9252</p>	<p>YEM-H10546</p>  <p>PC400-7/8 6156-81-9110 PC700-5/8 6261-81-9280</p>	<p>YEM-H10547</p>  <p>PC300-8 6CT8.3 喷油器线束</p>

插头系列 HARNESS SERIES

<p>YEM-H10548</p>  <p>二级管</p>	<p>YEM-H10549</p>  <p>保险片</p>	<p>YEM-H10550</p>  <p>保险片</p>	<p>YEM-H10551</p>  <p>E320D2 546-5029</p>	<p>YEM-H10552</p>  <p>HITACHI 保险片</p>
<p>YEM-H10553</p>  <p>保险片</p>	<p>YEM-H10554</p>  <p>保险片</p>	<p>YEM-H10555</p>  <p>1A 2A 3A 保险管</p>	<p>YEM-H10556</p>  <p>3W3000</p>	<p>YEM-H10557</p>  <p>HYUNDAI 二级</p>
<p>YEM-H10558</p>  <p>斗山 保险片</p>	<p>YEM-H10559</p>  <p>DOSAN DX 专用</p>	<p>YEM-H10560</p>  <p>DOSAN 斗山 整洗器</p>	<p>YEM-H10561</p>  <p>SANY 三一 二级管</p>	<p>YEM-H10562</p>  <p>1W0705</p>
<p>YEM-H10563</p>  <p>VOLVO 14626888 计时器 TIME METER</p>	<p>YEM-H10564</p>  <p>发电机组 计时器 TIME METER</p>	<p>YEM-H10565</p>  <p>CAT E320D2 计时器 TIME METER</p>	<p>YEM-H10566</p>  <p>CAT 计时器 TIME METER</p>	
<p>YEM-H10567</p>  <p>DH 计时器 TIME METER</p>	<p>YEM-H10568</p>  <p>通用计时器 TIME METER</p>	<p>YEM-H10569</p>  <p>SANY 计时器 TIME METER</p>	<p>YEM-H10570</p>  <p>EX 计时器</p>	
<p>YEM-H10571</p>  <p>计数器 电子式(装车用) ELECTRIC COUNTER</p>	<p>YEM-H10572</p>  <p>计数器机械式(装车用) MECHANICAL COUNTER</p>	<p>YEM-H10573</p>  <p>1W0702</p>	<p>YEM-H10574</p>  <p>1W0695</p>	

全车线束 WHOLE CAR WIRING HARNESS

YEM-H10575  VOLVO210B主外线D7D	YEM-H10576  VOLVO360B 单体泵发动机线束	YEM-H10577  VOLVO360B发电机线束	YEM-H10578  VOLVO360B主大线束	YEM-H10579  VOLVO460B 主外线
YEM-H10580  D6D D7D 沃尔沃发动机检测线	YEM-H10581  D6E D7E 沃尔沃发动机检测线	YEM-H10582  22248490	YEM-H10583  22117441	
YEM-H10584  沃尔沃250D/300D 电脑版线束14630822	YEM-H10585  沃尔沃360新款14612629	YEM-H10586  VOLVO460主线14612634	YEM-H10587  沃尔沃WECU线	

全车线束 WHOLE CAR WIRING HARNESS





YEM-H10588  SK250-8发动机线束	YEM-H10589  SK350-8发动机线束	YEM-H10590  SK250超8 全车线束	YEM-H10591  SK350超8 全车线束
YEM-H10592  SK230-6E发动机线束	YEM-H10593  SK460-8 喷油器线束	YEM-H10594  日立ZAX300-1液压泵线束	YEM-H10595  日立ZAX450-1液压泵线束
YEM-H10596  日立ZAX200-1外线束	YEM-H10597  日立ZAX120-1外线束	YEM-H10598  日立ZAX300-1外线束	YEM-H10599  日立ZAX450-1外线束
YEM-H10600  日立ZAX200-1显示屏线束	YEM-H10601  日立ZAX200-3 液压泵线束	YEM-H10602  日立ZAX300-3 液压泵线束	YEM-H10603  日立ZAX450-3 液压泵线束
YEM-H10604  日立EX200-3 液压泵线束	YEM-H10605  日立200-3内线束	YEM-H10606  日立原装进口EX200-5外线束	YEM-H10607  立原装进口EX200-5内线束
YEM-H10608  日立ZAX200-3发动机线束	YEM-H10609  日立ZAX350-3发动机线束	YEM-H10610  日立ZAX200-5G 外线束	YEM-H10611  日立EX120-5内线束

DOOSAN 斗山系列线束

驾驶室	150到420-7通用	530-00205	530-00206A	530-00209	530-00207B	530-00208E	530-00150	530-00231A	6005	530-00213	D11	530-00259B	530-002210	K1002288B	530-00408A	2530-245A	530Y00190B	530Y00327B	530Y00211B	530Y00229B	530Y00475B	220-V与300-V	2530-1427	2530-1601B	2530-1602B	2530-1603B	1609D10	2530-1604C	
					与208E配用		7通用	仪表线-7	空调	收音机	大灯线-7通用	DH 225-7	DH 300-7	DH 220-7	DH 150-7	DH370-7	DH 225-7	DH 220-7	DH 300-7	DH370-7	DH 150-7	V通用	V	V	V	V	大灯线-V	V	
主线束							2530-1604C	2530-1607M-A	2530-1630J	2530-1631B	2530-1608B	2510-1010	K1001468(2510-1008)	2530-1637B	2530-1636	2530Y1634H	2530Y1635B	2530Y1653	2530Y1633L	2530-00150	2530-1638C	530-00163A	530-00381C	530-00160B	530-00443	530-00380B	310207-00559	2530-00150	
发动机线束																													
驾驶室																													

全车线束 WHOLE CAR WIRING HARNESS

























全车线束 WHOLE CAR WIRING HARNESS

























YEM-H10612  PC120-6大机头外线束	YEM-H10613  PC120-6大机头内线束	YEM-H10614  PC300-6大机头内线束	YEM-H10615  PC300-6大机头外线束
YEM-H10616  PC400-6发动机线束	YEM-H10617  PC360-7发动机线束	YEM-H10618  PC200-7显示屏线束	YEM-H10619  PC200-8主外线束
YEM-H10620  PC400-8发动机线束	YEM-H10621  PC400-7发动机燃油嘴线束	YEM-H10622  PC400-7发动机线束	YEM-H10623  PC300-8主外线束
YEM-H10624  PC300-8发动机线束	YEM-H10625  PC200-8MO发动机线束	YEM-H10626  SK200-3 液压泵发动机线束	YEM-H10627  SK-6 液压泵线束
YEM-H10628  SK-6E 液压泵线束	YEM-H10629  SK-8 液压泵线束	YEM-H10630  SK120-3外线束	YEM-H10631  SK200-3外线束
YEM-H10632  SK200-6发动机线束	YEM-H10633  SK200-6E 外线束	YEM-H10634  SK200-6E发动机线束	YEM-H10635  SK230-6E内线束

YEM-H10636  日立合肥EX120-5外线束	YEM-H10637  住友SH240A5 外线束	YEM-H10638  住友SH200Z3外线束	YEM-H10639  住友SH200A5外线束
YEM-H10640  住友SH200A5内线束	YEM-H10641  加藤HD820-3外线束	YEM-H10642  加藤HD820-3液压泵线束	YEM-H10643  E325D 保险丝盒线束
YEM-H10644  卡特E307C车架外线束	YEM-H10645  E307C驾驶室地板线束	YEM-H10646  卡特E307D 全车外线束	YEM-H10647  卡特E311B 外线束
YEM-H10648  卡特E312B内线束	YEM-H10649  卡特E312B 外线束	YEM-H10650  E312C驾驶室底内线束	YEM-H10651  卡特E312C 外线束
YEM-H10652  E312D2GC车身外线束	YEM-H10653  卡特E312D发动机线束	YEM-H10654  卡特E312D 驾驶室内线束	YEM-H10655  卡特E312D 液压泵维修线束
YEM-H10656  卡特E320B外线束	YEM-H10657  卡特E320CU外线束	YEM-H10658  E320C驾驶室底盘内线束	YEM-H10659  E320C空调控制面板线束

全车线束 WHOLE CAR WIRING HARNESS

























全车线束 WHOLE CAR WIRING HARNESS

<p>YEM-H10660</p>  <p>卡特E320C外线束</p>	<p>YEM-H10661</p>  <p>卡特E320C显示屏线束</p>	<p>YEM-H10662</p>  <p>卡特E320D2发动机线束</p>	<p>YEM-H10663</p>  <p>卡特E320D2外线束</p>
<p>YEM-H10664</p>  <p>卡特E320D 空调线束</p>	<p>YEM-H10665</p>  <p>卡特E320D内线束直喷</p>	<p>YEM-H10666</p>  <p>卡特E320D内线束</p>	<p>YEM-H10667</p>  <p>卡特E320D外线束</p>
<p>YEM-H10668</p>  <p>卡特E323D 6.6 发动机线束</p>	<p>YEM-H10669</p>  <p>卡特E323D 外线束直喷</p>	<p>YEM-H10670</p>  <p>卡特E324D 外线束</p>	<p>YEM-H10671</p>  <p>卡特E325B发动机线束</p>
<p>YEM-H10672</p>  <p>卡特E325C发动机线束</p>	<p>YEM-H10673</p>  <p>卡特E325C外线束</p>	<p>YEM-H10674</p>  <p>卡特E325C 液压泵线束</p>	<p>YEM-H10675</p>  <p>卡特E325D发动机线束</p>
<p>YEM-H10676</p>  <p>卡特E325D内线束</p>	<p>YEM-H10677</p>  <p>卡特E325D外线束</p>	<p>YEM-H10678</p>  <p>卡特E329D2发动机线束</p>	<p>YEM-H10679</p>  <p>卡特E329D发动机线束</p>
<p>YEM-H10680</p>  <p>卡特E329D风扇泵线束</p>	<p>YEM-H10681</p>  <p>卡特E329D外线束</p>	<p>YEM-H10682</p>  <p>卡特E330B发动机线束</p>	<p>YEM-H10683</p>  <p>卡特E330C发动机线束</p>

<p>YEM-H10684</p>  <p>卡特E330C内线束</p>	<p>YEM-H10685</p>  <p>卡特E330C 外线束</p>	<p>YEM-H10686</p>  <p>卡特E330C 液压泵线束</p>	<p>YEM-H10687</p>  <p>卡特E330D 235-8202发动机线束</p>
<p>YEM-H10688</p>  <p>卡特E330D内线束</p>	<p>YEM-H10689</p>  <p>卡特E330D外线束</p>	<p>YEM-H10690</p>  <p>卡特E330D 液压泵维修线束</p>	<p>YEM-H10691</p>  <p>卡特E336D发动机线束</p>
<p>YEM-H10692</p>  <p>卡特E336D 液压泵维修线束</p>	<p>YEM-H10693</p>  <p>卡特E345B 发动机线束老款</p>	<p>YEM-H10694</p>  <p>卡特E345B发动机线束</p>	<p>YEM-H10695</p>  <p>E345C发动机电源线束</p>
<p>YEM-H10696</p>  <p>卡特E345C发动机线束</p>	<p>YEM-H10697</p>  <p>卡特E345C外线束</p>	<p>YEM-H10698</p>  <p>卡特E345D发动机电源线束</p>	<p>YEM-H10699</p>  <p>卡特E345D发动机线束</p>
<p>YEM-H10700</p>  <p>卡特E345D分配阀线束</p>	<p>YEM-H10701</p>  <p>卡特E345D外线束</p>	<p>YEM-H10702</p>  <p>卡特E365C 电磁阀线束</p>	<p>YEM-H10703</p>  <p>卡特E365C 电脑版线束</p>
<p>YEM-H10704</p>  <p>卡特E365C发动机线束</p>	<p>YEM-H10705</p>  <p>卡特E365C全车主外线束</p>	<p>YEM-H10706</p>  <p>卡特E374D发动机线束</p>	<p>YEM-H10707</p>  <p>卡特E374D 全车主外线束</p>

全车线束 WHOLE CAR WIRING HARNESS







盖类系列 TANK COVER SERIES

<p>YEM-H10708</p>  <p>卡特E374D主外线束</p>	<p>YEM-H10709</p>  <p>卡特E385B发动机线束</p>	<p>YEM-H10710</p>  <p>卡特E385B全车主外线束</p>	<p>YEM-H10711</p>  <p>卡特E385C发动机电源线束</p>
<p>YEM-H10712</p>  <p>卡特E385C发动机线束</p>	<p>YEM-H10713</p>  <p>卡特E385C全车主外线束</p>	<p>YEM-H10714</p>  <p>卡特E385C液压泵线束</p>	<p>YEM-H10715</p>  <p>卡特E385C主控阀线束</p>
<p>YEM-H10716</p>  <p>卡特E385C主外线束</p>	<p>YEM-H10717</p>  <p>卡特E390D 发动机线束</p>	<p>YEM-H10718</p>  <p>卡特C/D 综合测试线束</p>	<p>YEM-H10719</p>  <p>卡特C15 发动机线束</p>
<p>YEM-H10720</p>  <p>C7 机喷嘴线束</p>	<p>YEM-H10721</p>  <p>卡特C9 发动机喷嘴线束</p>	<p>YEM-H10722</p>  <p>VOLVO140B发动机线束</p>	<p>YEM-H10723</p>  <p>VOLVO140B主外线D4D</p>
<p>YEM-H10724</p>  <p>VOLVO210B 单体泵发动机线束</p>	<p>YEM-H10725</p>  <p>VOLVO210B 发动机电脑版线D6D</p>	<p>YEM-H10726</p>  <p>VOLVO210B发动机线束</p>	<p>YEM-H10727</p>  <p>VOLVO210B主外线D7D</p>
<p>YEM-H10728</p>  <p>VOLVO240B 单体泵发动机线束</p>	<p>YEM-H10729</p>  <p>VOLVO290B 发动机电脑版线</p>	<p>YEM-H10730</p>  <p>VOLVO290B 发动机电脑版线束D7D</p>	<p>YEM-H10731</p>  <p>VOLVO290B 发动机电脑版线</p>

<p>YEM-H10732</p>  <p>EX ZAX VOLVO约翰迪尔</p>	<p>YEM-H10733</p>  <p>VOLVO VOE20392751</p>	<p>YEM-H10734</p>  <p>JCB 柴油箱盖Fuel Tank Cap</p>	<p>YEM-H10735</p>  <p>康明斯</p>
<p>YEM-H10736</p>  <p>推土机液压油箱盖</p>	<p>YEM-H10737</p>  <p>VOLVO(NEW) 柴油盖FUELTANK CAP</p>	<p>YEM-H10738</p>  <p>TER EX 284-9039</p>	<p>YEM-H10739</p>  <p>凯斯</p>
<p>YEM-H10740</p>  <p>TER EX</p>	<p>YEM-H10741</p>  <p>竹内</p>	<p>YEM-H10742</p>  <p>SH电喷</p>	<p>YEM-H10743</p>  <p>VOLVO新款油箱盖</p>
<p>YEM-H10744</p>  <p>柴油箱盖 B型6孔*11高</p>	<p>YEM-H10745</p>  <p>柴油箱盖 A型6孔*78高</p>	<p>YEM-H10746</p>  <p>柴油箱盖 C型6孔*30高</p>	<p>YEM-H10747</p>  <p>呼吸滤带网</p>
<p>YEM-H10748</p>  <p>呼吸滤带螺丝</p>	<p>YEM-H10749</p>  <p>徐工/柳工 呼吸滤带网</p>	<p>YEM-H10750</p>  <p>C9 E336 水箱盖 WaterTank Cap</p>	<p>YEM-H10751</p>  <p>水箱盖 Water Tank Cap</p>

盖类系列 TANK COVER SERIES

盖类系列 TANK COVER SERIES

YEM-H10752  康明斯	YEM-H10753  洋马	YEM-H10754  PC200-8液压油箱盖	YEM-H10755  JCB 液压油箱盖	YEM-H10756  卡特CAT 492-3014
YEM-H10757  卡特CAT 540-7019	YEM-H10758  国产机 6孔呼吸滤 Breather	YEM-H10759  EC55B PBO 液压油箱呼吸器	YEM-H10760  福田	YEM-H10761  卡特CAT 220-0590
YEM-H10762  竹内	YEM-H10763  R现代	YEM-H10764  PC/DH小松/大宇	YEM-H10765  PC200-6/7 液压口盖HYD Hatch Cap	YEM-H10766  PC 小松
YEM-H10767  VOLVO/临工 油箱口	YEM-H10768  现代法兰盘总成油箱口	YEM-H10769  KOMATSU 小松油箱口/油箱口盖	YEM-H10770  HITACHI 日立油箱口/油箱口盖	YEM-H10771  DOOSAN 斗山油箱口/油箱口盖
YEM-H10772  CAT 卡特油箱口/油箱口盖	YEM-H10773  KOBELCO 神钢油箱口/油箱口盖	YEM-H10774  HYUNDAI 现代油箱口/油箱口盖	YEM-H10775  HYUNDAI 现代油箱口/油箱口盖	YEM-H10776  PC200-8 废气盖Breather

YEM-H10777  废气盖4HK1/6HK1	YEM-H10778  4HK1	YEM-H10779  废气通管 PC200-8 6D107 3971371	YEM-H10780  PC200-8 6754-21-6140	YEM-H10781  NT855 OEM:3418519
YEM-H10782  DOOSAN DH55	YEM-H10783  CAT E320D 帕金斯PERKINS	YEM-H10784  CAT C6.6 废气盖	YEM-H10785  废气盖底座 C7 NEWAT C79Y-2988 废气盖	YEM-H10786  黄色弯头
YEM-H10787  CAT E330CC9 废气盖	YEM-H10788  CAT E336D 废气盖	YEM-H10789  水堵	YEM-H10790  呼吸箱壳 6CT8.3 大字65.01801-5100呼吸器	YEM-H10791  黑色圆形盖
YEM-H10792  机油盖PC400-7 MT855	YEM-H10793  CAT C9	YEM-H10794  PC60/EX100	YEM-H10795  SH120/EX120/R220	YEM-H10796  VOLVO360 付水箱盖
YEM-H10797  21438311 145kPa	YEM-H10798  VOLVO360 机油盖	YEM-H10799  VOLVO350D D8K 机油口盖	YEM-H10800  CAT GC	YEM-H10801  CAT

锁系列 LOCK

<p>YEM-H10802</p>  <p>EX200-5反锁</p>	<p>YEM-H10803</p>  <p>R60-9 NEW</p>	<p>YEM-H10804</p>  <p>R60-9后盖锁</p>	<p>YEM-H10805</p>  <p>ZAX电喷前挡锁</p>
<p>YEM-H10806</p>  <p>SHA5/凯斯后盖锁</p>	<p>YEM-H10807</p>  <p>山河智能后盖锁</p>	<p>YEM-H10808</p>  <p>R-7工具箱锁</p>	<p>YEM-H10809</p>  <p>门锁拉手</p>
<p>YEM-H10810</p>  <p>SH60反扣锁</p>	<p>YEM-H10811</p>  <p>PC56/70-8缸盖锁</p>	<p>YEM-H10812</p>  <p>E320D2</p>	<p>YEM-H10813</p>  <p>E307/305.5边门锁</p>
<p>YEM-H10814</p>  <p>CAT GC工具箱锁</p>	<p>YEM-H10815</p>  <p>ZAX工具箱锁</p>	<p>YEM-H10816</p>  <p>DH55后备箱锁</p>	<p>YEM-H10817</p>  <p>日立70工具箱锁</p>
<p>YEM-H10818</p>  <p>卡特挂锁</p>	<p>YEM-H10819</p>  <p>VOLVO反扣锁</p>	<p>YEM-H10820</p>  <p>HYUNDAI 现代60-7 前档锁反面</p>	<p>YEM-H10821</p>  <p>KOMATSU神钢右侧玻璃窗扣</p>

锁系列 LOCK

<p>YEM-H10822</p>  <p>ZAXS-5G门锁总成</p>	<p>YEM-H10823</p>  <p>SK超10</p>	<p>YEM-H10824</p>  <p>门锁总成VOLVO60</p>	<p>YEM-H10825</p>  <p>SANY55</p>
<p>YEM-H10826</p>  <p>福田60新款</p>	<p>YEM-H10827</p>  <p>福田老款</p>	<p>YEM-H10828</p>  <p>卡特GC 发动机罩锁</p>	<p>YEM-H10829</p>  <p>小挖后盖锁</p>
<p>YEM-H10830</p>  <p>小挖后盖锁</p>	<p>YEM-H10831</p>  <p>大宇80后盖锁</p>	<p>YEM-H10832</p>  <p>PC200-8</p>	<p>YEM-H10833</p>  <p>通用新款反扣锁</p>
<p>YEM-H10834</p>  <p>CAT GC反扣锁</p>	<p>YEM-H10835</p>  <p>玉柴60-8反扣锁</p>	<p>YEM-H10836</p>  <p>柳工反扣锁</p>	<p>YEM-H10837</p>  <p>DH55</p>
<p>YEM-H10838</p>  <p>现代HYUNDAI 安全锁</p>	<p>YEM-H10839</p>  <p>加藤820反扣锁</p>	<p>YEM-H10840</p>  <p>SH60/280 反锁</p>	<p>YEM-H10841</p>  <p>现代60-7反扣锁</p>

锁系列 LOCK

YEM-H10842  柳工	YEM-H10843  DH	YEM-H10844  三一 SANY	YEM-H10845  PC-6
YEM-H10846  PC-8	YEM-H10847  PC-8门锁芯	YEM-H10848  PC-8MO	YEM-H10849  PC-8 电瓶箱锁
YEM-H10850  R60-7工具箱锁	YEM-H10851  B HITACHI	YEM-H10852  CAT	YEM-H10853  D 住友
YEM-H10854  R	YEM-H10855  VOLVO	YEM-H10856  SK	YEM-H10857  SHA1/A2边门锁
YEM-H10858  DH55/60	YEM-H10859  柳工	YEM-H10860  PC	YEM-H10861  DH300边门锁芯通用

锁系列 LOCK

YEM-H10862  PC-7/8引擎盖锁面	YEM-H10863  PC-8MO	YEM-H10864  CAT 325D	YEM-H10865  CAT GC	YEM-H10866  CAT E308
YEM-H10867  R-9	YEM-H10868  液压泵门锁 DX-9	YEM-H10869  VOLVO55后备锁	YEM-H10870  柳工	YEM-H10871  CAT玻璃扣(胶/铝) Glass Buckle
YEM-H10872  CAT天窗扣 玻璃扣(胶/铝)Glass Buckle	YEM-H10873  KOTO加藤(左右)	YEM-H10874  HITACHI 日立60/70 右侧窗扣	YEM-H10875  PC200-7/8 下档固定块	YEM-H10876  HITACHI
YEM-H10877  R-9发动机缸盖锁	YEM-H10878  DH300发动机缸盖锁	YEM-H10879  SK460/480 发动机缸盖锁	YEM-H10880  车门合页	YEM-H10881  HITACHI 车门合页
YEM-H10882  PC200-6 车门合页	YEM-H10883  PC-7边门合页	YEM-H10884  车门合页	YEM-H10885  车门合页	YEM-H10886  DH合页
YEM-H10887  车门合页	YEM-H10888  玻璃滑轮	YEM-H10889  PC-7提扣	YEM-H10890  U型螺丝	YEM-H10891  神钢门顶胶





















锁系列 LOCK

转向器 STEERING GEAR

<p>YEM-H10892</p>  <p>日立/斗山</p>	<p>YEM-H10893</p>  <p>卡特</p>	<p>YEM-H10894</p>  <p>VOLVO 前档托</p>	<p>YEM-H10895</p>  <p>PC200-7</p>
<p>YEM-H10896</p>  <p>反扣锁拉线日立60/70</p>	<p>YEM-H10897</p>  <p>反扣锁拉线现代-9</p>	<p>YEM-H10898</p>  <p>反扣锁拉线住友A1</p>	<p>YEM-H10899</p>  <p>反扣锁拉线CAT</p>























YEM-H10900

										
1.(H800)	2.(5P8500)	3.(14607)	4.(777)	5.(VOLVO)	6.(PC-8)	6.(8157766)	8.(2498)	9.(H806)	10.(NG100)	11.(JD)
										
12.(D250)	13.(455)	14.(9901)	15.(166)	16.(373)	17.(SKYJ)	18.(8398)	19.(53630)	20.(12343)	21.(301)	
										
22.(55240)	23.(T250)	24.(83353)	25.(430)	26.(MS634212)	27.(JDG)	28.(JDS)	29.(14685)	30.(R点火)	31.(DH点火)	
										
32.(DH)	33.(SANY)	34.(R-9)	35(常林)	36.(CAT)	37.(HD62)	38.(K250)	39.(787)	40.(TABO)	41.(S450)	42.(F900)

<p>YEM-H10901</p>  <p>701 21201</p>	<p>YEM-H10902</p>  <p>701 21202</p>	<p>YEM-H10903</p>  <p>701 37702</p>	<p>YEM-H10904</p>  <p>701 52601</p>
<p>YEM-H10905</p>  <p>701 70001</p>	<p>YEM-H10906</p>  <p>701 80145</p>	<p>YEM-H10907</p>  <p>701 80295</p>	<p>YEM-H10908</p>  <p>701 80298</p>
<p>YEM-H10909</p>  <p>701 80299</p>	<p>YEM-H10910</p>  <p>701180297</p>	<p>YEM-H10911</p>  <p>101180296</p>	<p>YEM-H10912</p>  <p>11039407</p>
<p>YEM-H10913</p>  <p>11171772</p>	<p>YEM-H10914</p>  <p>11192586</p>	<p>YEM-H10915</p>  <p>15095375</p>	<p>YEM-H10916</p>  <p>11170339</p>
<p>YEM-H10917</p>  <p>11192582</p>	<p>YEM-H10918</p>  <p>0501216209</p>	<p>YEM-H10919</p>  <p>310-9354</p>	<p>YEM-H10920</p>  <p>0501216205</p>

转向器 STEERING GEAR



油水分离器 OIL SEPARATOR





<p>YEM-H10921</p>  <p>45625 60140</p>	<p>YEM-H10922</p>  <p>CAT 261-2207</p>	<p>YEM-H10923</p>  <p>WA380-3 417-43-26331</p>	<p>YEM-H10924</p>  <p>P110 WA300 WA350 WA600 WA700 WD600 WF550 421-43-26122</p>
<p>YEM-H10925</p>  <p>大宇 现代轮挖二档</p>	<p>YEM-H10926</p>  <p>大宇 现代轮挖二档0765.0600</p>	<p>YEM-H10927</p>  <p>日立ZAX60/70液压先导锁</p>	<p>YEM-H10928</p>  <p>SANY三一-9</p>
<p>YEM-H10929</p>  <p>日立120/200/230/240/300-6-3G 液压先导锁</p>	<p>YEM-H10930</p>  <p>ZAX电喷</p>	<p>YEM-H10931</p>  <p>柳工安全锁</p>	<p>YEM-H10932</p>  <p>VOLVO210D</p>
<p>YEM-H10933</p>  <p>R225-9</p>	<p>YEM-H10934</p>  <p>DH</p>	<p>YEM-H10935</p>  <p>安全锁</p>	<p>YEM-H10936</p>  <p>SK-6</p>
<p>YEM-H10937</p>  <p>SK-8</p>	<p>YEM-H10938</p>  <p>SHA3</p>	<p>YEM-H10939</p>  <p>CAT GC</p>	<p>YEM-H10940</p>  <p>SANY三一 老款</p>
<p>YEM-H10941</p>  <p>WA470 WA380 417-43-26230</p>	<p>YEM-H10942</p>  <p>30A 50VAD 125/250VAC</p>	<p>YEM-H10943</p>  <p>紧急开关 WA320 WA500 417-43-26230</p>	

<p>YEM-H10944</p>  <p>363-5819</p>	<p>YEM-H10945</p>  <p>DX150-9</p>	<p>YEM-H10946</p>  <p>洋马85</p>	<p>YEM-H10947</p>  <p>洋马铁通</p>	
<p>YEM-H10948</p>  <p>柳工926E</p>	<p>YEM-H10949</p>  <p>SK-10</p>	<p>YEM-H10950</p>  <p>CAT 308-7298</p>	<p>YEM-H10951</p>  <p>JCB CAT 228-9130</p>	
<p>YEM-H10952</p>  <p>JCB CAT 361-9554</p>	<p>YEM-H10953</p>  <p>JCB111-4089总成</p>	<p>YEM-H10954</p>  <p>JCB CAT</p>	<p>YEM-H10955</p>  <p>JCB CAT 32-925915</p>	
<p>YEM-H10956</p>  <p>368-3976 E320D2</p>	<p>YEM-H10957</p>  <p>322-3154 E320D2</p>	<p>YEM-H10958</p>  <p>CAT 油水分离器</p>	<p>YEM-H10959</p>  <p>FS1098</p>	
<p>YEM-H10960</p>  <p>PC200-8</p>	<p>YEM-H10961</p>  <p>FF63009</p>	<p>YEM-H10962</p>  <p>徐工</p>	<p>YEM-H10963</p>  <p>FF5706</p>	<p>YEM-H10964</p>  <p>439-5037</p>

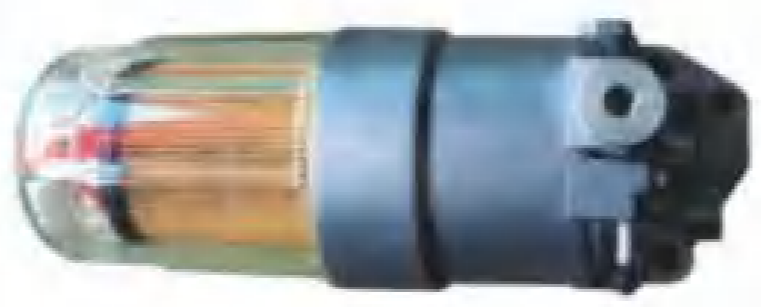



























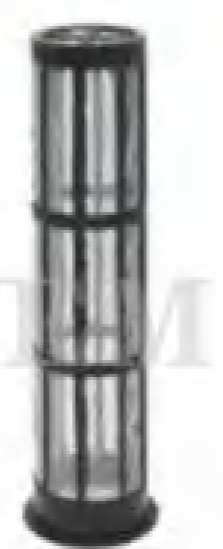

油水分离器 OIL SEPARATOR

油水分离杯 OIL SEP CUP

<p>YEM-H10965</p>  <p>日立350-5A 037134油杯</p>	<p>YEM-H10966</p>  <p>小松5410油杯</p>	<p>YEM-H10967</p>  <p>20019大油杯</p>	<p>YEM-H10968</p>  <p>ZAX 4642641</p>
<p>YEM-H10969</p>  <p>三一215-10带泵</p>	<p>YEM-H10970</p>  <p>三一215-10</p>	<p>YEM-H10971</p>  <p>油水分离器 Oil Separator 600FH</p>	<p>YEM-H10972</p>  <p>油水分离器300FH</p>
<p>YEM-H10973</p>  <p>洋马YANMAR 129335-55701</p>	<p>YEM-H10974</p>  <p>PC-8 600-311-9732</p>	<p>YEM-H10975</p>  <p>洋马YANMAR 129335-55701</p>	<p>YEM-H10976</p>  <p>洋马YANMAR 4管/5管 129100-55621</p>
<p>YEM-H10977</p>  <p>三一215-10油水(带手压泵)</p>	<p>YEM-H10978</p>  <p>三一245油水(带开关) A14-14606</p>	<p>YEM-H10979</p>  <p>FF266总成</p>	<p>YEM-H10980</p>  <p>141油水</p>
<p>YEM-H10981</p>  <p>石川岛油水</p>	<p>YEM-H10982</p>  <p>石川岛</p>	<p>YEM-H10983</p>  <p>ISUZU EX</p>	<p>YEM-H10984</p>  <p>ZAX-38-980742880</p>
<p>YEM-H10985</p>  <p>SK75</p>	<p>YEM-H10986</p>  <p>DX60-9C</p>	<p>YEM-H10987</p>  <p>SK200-8</p>	<p>YEM-H10988</p>  <p>SK200-10 SK350超8</p>

<p>YEM-H10989</p>  <p>PC70-8</p>	<p>YEM-H10990</p>  <p>PC200-8</p>	<p>YEM-H10991</p>  <p>PC200-8 NEW</p>	<p>YEM-H10992</p>  <p>600-319-5410小松新款</p>
<p>YEM-H10993</p>  <p>OEM:R60T/R90T/R120T</p>	<p>YEM-H10994</p>  <p>JCB 320-07483 117-4089 新款</p>	<p>YEM-H10995</p>  <p>OEM:ISUZU</p>	<p>YEM-H10996</p>  <p>五十铃 新款</p>
<p>YEM-H10997</p>  <p>VOLVO</p>	<p>YEM-H10998</p>  <p>VOLVO</p>	<p>YEM-H10999</p>  <p>OEM:R60P/R90P/R120P HEATER</p>	<p>YEM-H11000</p>  <p>SK260-10</p>
<p>YEM-H11001</p>  <p>DX225-9 SP00062</p>	<p>YEM-H11002</p>  <p>DX150-9</p>	<p>YEM-H11003</p>  <p>A B</p>	<p>YEM-H11004</p>  <p>CAT310-5912</p>
<p>YEM-H11005</p>  <p>R90P油杯加热 带传感线</p>	<p>YEM-H11006</p>  <p>洋马</p>	<p>YEM-H11007</p>  <p>PC200-6</p>	<p>YEM-H11008</p>  <p>PC200-7</p>
<p>YEM-H11009</p>  <p>PC200-8</p>	<p>YEM-H11010</p>  <p>20019油杯</p>	<p>YEM-H11011</p>  <p>三一245 油杯总成</p>	<p>YEM-H11012</p>  <p>19765 油杯</p>

滤网 STRAINER

<p>YEM-H11013</p>  <p>液压滤网</p>	<p>YEM-H11014</p>  <p>VOLVO 360</p>	<p>YEM-H11015</p>  <p>VOLVO210 14650315</p>	<p>YEM-H11016</p>  <p>三一</p>	<p>YEM-H11017</p>  <p>临工</p>	<p>YEM-H11018</p>  <p>PC200-7 207-60-61250</p>
<p>YEM-H11019</p>  <p>PC300-6 LDTNO-6177</p>	<p>YEM-H11020</p>  <p>21N-62-31221</p>	<p>YEM-H11021</p>  <p>SK200-8 SK380-8 YN50V00020F1</p>	<p>YEM-H11022</p>  <p>JCB</p>	<p>YEM-H11023</p>  <p>Sk滤网</p>	<p>YEM-H11024</p>  <p>R</p>
<p>YEM-H11025</p>  <p>PC-7</p>	<p>YEM-H11026</p>  <p>R/EX/VOLVO</p>	<p>YEM-H11027</p>  <p>EX HD</p>	<p>YEM-H11028</p>  <p>R215-7</p>	<p>YEM-H11029</p>  <p>油浴式空滤总成(加装)</p>	
<p>YEM-H11030</p>  <p>E312B/C ZAXIS120 SK120-6(直管)</p>	<p>YEM-H11031</p>  <p>SK120-6(弯管)</p>	<p>YEM-H11032</p>  <p>SK140-8 SK130-8 空滤总成</p>	<p>YEM-H11033</p>  <p>Dh55</p>	<p>YEM-H11034</p>  <p>R60-9</p>	
<p>YEM-H11035</p>  <p>小铜网 Copper Sieve</p>	<p>YEM-H11036</p>  <p>PC400-7</p>	<p>YEM-H11037</p>  <p>装载机通用防雨帽 Φ80mm</p>	<p>YEM-H11038</p>  <p>防雨帽 Φ78mm</p>	<p>YEM-H11039</p>  <p>防雨帽 Φ102mm</p>	
<p>YEM-H11040</p>  <p>临工60.65防雨帽 Φ64mm</p>	<p>YEM-H11041</p>  <p>临工80.90防雨帽 Φ83mm</p>	<p>YEM-H11042</p>  <p>临工210防雨帽 Φ127mm</p>	<p>YEM-H11043</p>  <p>卡特预滤器NEW Φ127mm</p>	<p>YEM-H11044</p>  <p>卡特预滤器NEW Φ152mm</p>	

倒车镜 REARVIEW MIRROR

<p>YEM-H11045</p>  <p>小松56-7 尺寸:15*25cm</p>	<p>YEM-H11046</p>  <p>小松-8代用款 长30cm 宽23cm</p>	<p>YEM-H11047</p>  <p>小松油箱扶手镜 长:33cm 宽:25cm</p>	<p>YEM-H11048</p>  <p>住友优质款 尺寸:19*33cm</p>
<p>YEM-H11049</p>  <p>厦工/龙工/神钢/柳工 尺寸:16.5*32cm</p>	<p>YEM-H11050</p>  <p>8寸中夹款 直径20cm</p>	<p>YEM-H11051</p>  <p>新源轮挖专用 尺寸:19*32cm</p>	<p>YEM-H11052</p>  <p>编号:758 小松-8专用款 尺寸:长32cm 宽23cm</p>
<p>YEM-H11053</p>  <p>小松PC-8 原款镜(微凸) 配重油箱直径26cm</p>	<p>YEM-H11054</p>  <p>8寸中夹款 直径20cm</p>	<p>YEM-H11055</p>  <p>小松PC-8 原款镜(微凸) 配重油箱直径26cm</p>	<p>YEM-H11056</p>  <p>10寸中球款 小松配重 直径25cm</p>
<p>YEM-H11057</p>  <p>长:27cm 宽:17cm 长:38cm 宽:19cm 卡特原款镜</p>	<p>YEM-H11058</p>  <p>小方镜 长:24cm 宽:20cm</p>	<p>YEM-H11059</p>  <p>椭圆形通用款</p>	<p>YEM-H11060</p>  <p>日立原车镜 长:31cm 宽:23cm</p>
<p>YEM-H11061</p>  <p>10寸中球款 小松配重 直径 25cm</p>	<p>YEM-H11062</p>  <p>小松-8代用款 长:30cm 宽:23cm</p>	<p>YEM-H11063</p>  <p>加强型 加装/代用款 尺寸:23*31cm</p>	<p>YEM-H11064</p>  <p>沃尔沃款 长27.5cm 宽18cm</p>
<p>YEM-H11065</p>  <p>8寸圆镜 直径20cm 管夹安装款</p>	<p>YEM-H11066</p>  <p>小方镜 长:24cm 宽:20cm</p>	<p>YEM-H11067</p>  <p>卡特长款 长38cm 宽19cm</p>	<p>YEM-H11068</p>  <p>10寸圆镜 直径25cm 螺杆安装款</p>

倒车镜 REARVIEW MIRROR

雨刮电机系列 WIPER MOTOR

<p>YEM-H11069</p>  <p>斗山/大宇款 29*17cm</p>	<p>YEM-H11070</p>  <p>小松-6/住友 边门 长:32cm 宽:18cm</p>	<p>YEM-H11071</p>  <p>小松油箱扶手镜 长:33cm 宽:25cm</p>	<p>YEM-H11072</p>  <p>8寸中球款 小松配重 直径20cm</p>	<p>YEM-H11073</p>  <p>新源反光镜 长32cm 宽20cm</p>
<p>YEM-H11074</p>  <p>B款现代 尺寸:18/30cm</p>	<p>YEM-H11075</p>  <p>小松-8专用款 长32cm 宽23cm</p>	<p>YEM-H11076</p>  <p>卡特/沃尔沃/临工/三一/徐工 多机型通用款 尺寸:16*31cm</p>	<p>YEM-H11077</p>  <p>10寸中夹款 直径25cm</p>	<p>YEM-H11078</p>  <p>小松油箱扶手镜 长:33cm 宽:25cm</p>
<p>YEM-H11079</p>  <p>通用型/L型 适用扶手直径: 21mm/25mm</p>	<p>YEM-H11080</p>  <p>日立 驾驶室支架</p>	<p>YEM-H11081</p>  <p>斗山/大宇 驾驶室支架</p>	<p>YEM-H11082</p>  <p>卡特 驾驶室镜支架</p>	<p>YEM-H11083</p>  <p>国产轮挖 镜支架 驾驶室 工具箱一样 新源/远山/劲工/鑫豪/海华</p>
<p>YEM-H11084</p>  <p>临工/沃尔沃 工具箱镜支架</p>	<p>YEM-H11085</p>  <p>铁支架 适用扶手直径 25mm-28mm</p>	<p>YEM-H11086</p>  <p>徐工 工具箱镜支架</p>	<p>YEM-H11087</p>  <p>卡特 工具箱镜支架</p>	<p>YEM-H11088</p>  <p>小松-8 配重镜支架 油箱镜支架</p>
<p>YEM-H11089</p>  <p>现代轮挖驾驶室 镜支架</p>	<p>YEM-H11090</p>  <p>小松右边大扶手镜支架 孔径: 32mm</p>	<p>YEM-H11091</p>  <p>铁支架 适用扶手 直径25mm-28mm</p>	<p>YEM-H11092</p>  <p>现代驾驶室镜支架</p>	<p>YEM-H11093</p>  <p>临工/沃尔沃 驾驶室镜支架</p>

<p>YEM-H11094</p>  <p>E330 雨刮电机 Wiper Motor</p>	<p>YEM-H11095</p>  <p>卡特 CAT E336D 雨刮电机 Wiper Motor</p>	<p>YEM-H11096</p>  <p>卡特CAT E374 雨刮电机 Wiper Motor</p>	<p>YEM-H11097</p>  <p>PC56 雨刮电机 Wiper Motor</p>
<p>YEM-H11098</p>  <p>神钢超8 雨刮电机 Wiper Motor</p>	<p>YEM-H11099</p>  <p>E320D 雨刮电机 Wiper Motor</p>	<p>YEM-H11100</p>  <p>住友SH210-6 雨刮电机 Wiper Motor</p>	<p>YEM-H11101</p>  <p>JCB</p>
<p>YEM-H11102</p>  <p>雷沃国产机105°</p>	<p>YEM-H11103</p>  <p>柳工904-905</p>	<p>YEM-H11104</p>  <p>柳工906-908</p>	<p>YEM-H11105</p>  <p>柳工E系列</p>
<p>YEM-H11106</p>  <p>ZAX-5G 雨刮电机 Wiper Motor</p>	<p>YEM-H11107</p>  <p>徐工500K</p>	<p>YEM-H11108</p>  <p>轮试挖掘机24V 90°</p>	<p>YEM-H11109</p>  <p>约翰迪尔</p>
<p>YEM-H11110</p>  <p>E336GC</p>	<p>YEM-H11111</p>  <p>SHA3</p>	<p>YEM-H11112</p>  <p>ZAX-5A反方向</p>	<p>YEM-H11113</p>  <p>柳工906D</p>

副水箱 TANK ASSY

油阀传感器 FUEL TANK SENSOR

<p>YEM-H11114</p>  <p>VOLVO750 21883433 22430043</p>	<p>YEM-H11115</p>  <p>VOLVO 1676400</p>	<p>YEM-H11116</p>  <p>VOLVO300D/350D</p>	<p>YEM-H11117</p>  <p>VOLVO 22821828 22430366</p>	<p>YEM-H11118</p>  <p>PC40/50</p>
<p>YEM-H11119</p>  <p>DH60-7</p>	<p>YEM-H11120</p>  <p>徐工Radiator</p>	<p>YEM-H11121</p>  <p>徐工 喷水壶 Clean Tank Assy</p>	<p>YEM-H11122</p>  <p>ZAX240-5G ZAX330-5A YA00038910</p>	<p>YEM-H11123</p>  <p>SK350-8</p>
<p>YEM-H11124</p>  <p>柳工 喷水壶Radiator</p>	<p>YEM-H11125</p>  <p>PC 洗涤壶</p>	<p>YEM-H11126</p>  <p>E307</p>	<p>YEM-H11127</p>  <p>洋马</p>	<p>YEM-H11128</p>  <p>PC20</p>
<p>YEM-H11129</p>  <p>SH</p>	<p>YEM-H11130</p>  <p>约翰迪尔</p>	<p>YEM-H11131</p>  <p>JBC不带传感器</p>	<p>YEM-H11132</p>  <p>JBC带传感器</p>	
<p>YEM-H11133</p>  <p>CAT E120K E160K 248-6199 277-4836</p>	<p>YEM-H11134</p>  <p>CAT E349E 505-0524 398-0877</p>	<p>YEM-H11135</p>  <p>CAT E320GC 511-0264</p>	<p>YEM-H11136</p>  <p>CAT 544-9412</p>	
<p>YEM-H11137</p>  <p>DX60洗涤壶</p>	<p>YEM-H11138</p>  <p>JCB331-32842 162-03297</p>	<p>YEM-H11139</p>  <p>JBC332-E9125</p>	<p>YEM-H11140</p>  <p>JBC128-15313</p>	

<p>YEM-H11141</p>  <p>PC55 小挖</p>	<p>YEM-H11142</p>  <p>VOLVO360 720mm</p>	<p>YEM-H11143</p>  <p>油箱浮子 厦工 中/大</p>
<p>YEM-H11144</p>  <p>R305/335-7 880mm</p>	<p>YEM-H11145</p>  <p>油箱浮子 龙工小挖带插 500mm</p>	<p>YEM-H11146</p>  <p>油箱浮子 柳工908D 720mm</p>
<p>YEM-H11147</p>  <p>油箱浮子 龙工小挖 560mm</p>	<p>YEM-H11148</p>  <p>油箱浮子 厦工806/808 700mm</p>	<p>YEM-H11149</p>  <p>CAT320GC</p>
<p>YEM-H11150</p>  <p>YC 550mm</p>	<p>YEM-H11151</p>  <p>YC 730mm</p>	<p>YEM-H11152</p>  <p>徐工260 710mm</p>
<p>YEM-H11153</p>  <p>徐工370 810mm</p>	<p>YEM-H11154</p>  <p>力士德 700mm</p>	<p>YEM-H11155</p>  <p>DX150-9 DX380-9 780mm</p>

撑杆 ARM-TIE

YEM-H11156

A:PC200-7护罩支撑



B:PC300-7护罩支撑

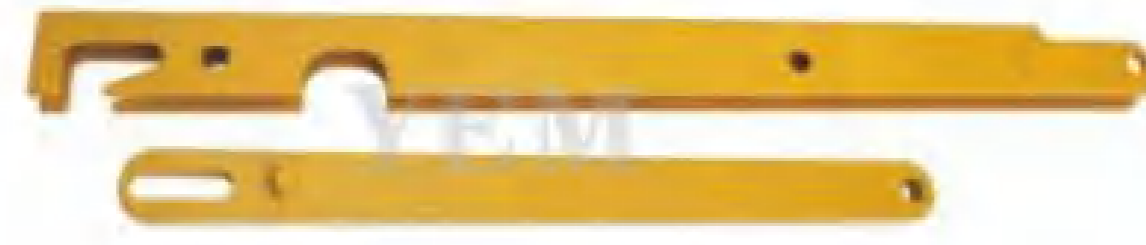

C:DH55发动机盖气弹簧 L:39cm



D:DH60发动机盖气弹簧 L:73cm



E:R215/225顶窗气弹簧 L:37cm



F:R55-7/60-5发动机盖气弹簧 L:74.5cm



G:R60-7/55-7S发动机盖气弹簧 L:70cm



H:R-5工具箱气弹簧 L:50.8cm



L:R200/210发动机盖气弹簧 L:76cm



J:R80-7发动机盖气弹簧 L:57.5cm



K:R60-7/215-7安全气弹簧 L:23.2cm

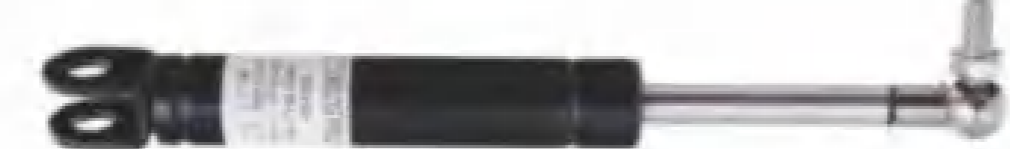

L:R55-7/60-5安全气弹簧 L:21.5cm



M:SK-6/8 顶窗气弹簧 L:35.3cm



N:DH225-7安全气弹簧 L:22.8cm



O:EX工具箱气弹簧 L:48.5cm



P:EX60/70/80发动机盖气弹簧 L:50.3cm



Q:DH55安全气弹簧 L:24.8cm



R:PC200/220/240-8工具箱气弹簧 L:69cm



S:DH300/370-7发动机盖气弹簧 L:48cm



撑杆 ARM-TIE

1	撑杆	总长82厘米
2	撑杆	"PC-8 发动机盖68厘米 总长675"
3	撑杆	E305.5发动机盖 27厘米
4	撑杆	三一55/60-9/34厘米
5	撑杆	PC200-6/8天窗37厘米
6	撑杆	R210-7发动机盖 75厘米
7	撑杆	R225-9发动机盖75厘米
8	撑杆	R55-7 后盖73厘米
9	撑杆	"R-7工具箱48厘米总长480"
10	撑杆	R80-7后盖58厘米
11	撑杆	临工60发动机 60厘米
12	撑杆	PC200-8MO发动机68厘米
13	撑杆	"DH-7操纵杆23.5厘米总长220"
14	撑杆	R60/225-7操纵杆23厘米
15	撑杆	徐工80 后盖43厘米
16	撑杆	E320D2 工具箱40厘米
17	撑杆	E320D2 后盖97厘米
18	撑杆	临工906手柄23厘米
19	撑杆	E307D后盖48厘米
20	撑杆	DX260工具箱52厘米
21	撑杆	雷沃60机盖28厘米
22	撑杆	雷沃60-7 后撑28厘米
23	撑杆	DH225-7 后盖47厘米
24	撑杆	徐工60 后盖60厘米
25	撑杆	"SK200-8手柄28厘米总长277"
26	撑杆	"DH-7发动机盖47厘米总长460"
27	撑杆	"SK-8操纵杆30厘米总长300"
28	撑杆	三一75-8 后盖70厘米

29	撑杆	VOLVO210工具箱52厘米
30	撑杆	福田80 后盖35厘米
31	撑杆	山河智能80 后盖36厘米
32	撑杆	ZAX70 天窗47厘米
33	撑杆	总长50厘米
34	撑杆	E320C 行走、无
35	撑杆	DX260座椅、无
36	撑杆	柳工908D后盖43厘米
37	撑杆	DH-7天窗29厘米
38	撑杆	E312D2 后盖77厘米
39	撑杆	VOLVO55 后盖69厘米
40	撑杆	"PC天窗39厘米总长390"
41	撑杆	玉柴60-8手柄18.5厘米
42	撑杆	"通用天窗35厘米总长350"
43	撑杆	DH300-7 后盖47厘米
44	撑杆	SK60-8/120-5 后盖45厘米
45	撑杆	石川岛手柄26厘米
46	撑杆	EX450 后盖75厘米
47	撑杆	EX470 后盖75厘米
48	撑杆	PC200、68厘米
49	撑杆	YC85-5 后29厘米
50	撑杆	"DH55 操纵杆22.5厘米总长223"
51	撑杆	久保田155 后盖31厘米
52	撑杆	SK60C 后盖55厘米
53	撑杆	E315D2 后盖77厘米
54	撑杆	SH240A5 天窗34厘米
55	撑杆	SK200-6/8 天窗35厘米
56	撑杆	SK430(总长)43厘米

放油阀 OILDRAIN VALVE

工具类 TOOLS

YEM-H11157  KOMATSU M22	YEM-H11158  放油阀CAT E329/336 M19	YEM-H11159  CAT M24 518015	YEM-H11160  KOBELCO M18	YEM-H11161  HITACHI ZAX M20
YEM-H11162  HITACHI M24	YEM-H11163  HYUNDAI R385 M25	YEM-H11164  油底壳放油阀 大宇DOOSAN M27	YEM-H11165  放油阀洋马YANMARM25	YEM-H11166  暖风开关 DH220-5 DOOSAN HYUNDAI
YEM-H11167  DOOSAN DH300-5	YEM-H11168  暖风开关	YEM-H11169  暖风开关	YEM-H11170  小松-6先导锁开关	YEM-H11171  CAT
YEM-H11172  开关	YEM-H11173  E336	YEM-H11174  VOLVO DOOSAN M30	YEM-H11175  VOLVO210 DOOSAN M27	YEM-H11176  小松KOMATSU M22
YEM-H11177  4HK1/6HK1 M24	YEM-H11178  日立 ZAX M20	YEM-H11179  神钢KOBELCO M18	YEM-H11180  现代R385 M25	YEM-H11181  卡特CAT M24细牙
YEM-H11182  油箱开关 PC200 EX200	YEM-H11183  油箱开关PC300 DH300	YEM-H11184  斗山 DOOSAN	YEM-H11185  207-6403	

YEM-H11186  曲前-4HK1	YEM-H11187  4HK1曲前曲后油封工具	YEM-H11188  4JG1曲轴油封工具曲前曲后	YEM-H11189  曲后-6BG1
YEM-H11190  6D34曲轴后油封安装工具	YEM-H11191  6WG1曲前曲后油封工具	YEM-H11192  J05/J08曲前曲后油封工具	YEM-H11193  S6K/C6.4曲后油封安装工具
YEM-H11194  S6K原装款	YEM-H11195  4D95/6D95曲轴油封工具前后	YEM-H11196  6D102曲前/曲后	YEM-H11197  6UZ1
YEM-H11198  曲后-DB58	YEM-H11199  4JJ1曲前/曲后	YEM-H11200  4JJ1曲前	YEM-H11201  曲前P11C (SK460/480)
YEM-H11202  曲后 P11C (SK460/480)	YEM-H11203  曲前曲后油封工具SK75-8	YEM-H11204  曲后油封工具D1146	YEM-H11205  液压泵流量扳手

YEM-H11206



涨紧轮专用扳手
Bolt Tight Wheel

YEM-H11207



高档气动枪头

YEM-H11208



小套铜AB

YEM-H11209



套筒

YEM-H11226



24V清洗泵

YEM-H11227



钢丝耐油管 SteelOil Tube

YEM-H11228



过滤器 Filter

YEM-H11229



黄油枪 Grease Gun

YEM-H11210



电动计量表 Gauge

YEM-H11211



油缸大号扳手 六角螺母扳手
适用机型240-650型
最大长度620mm

YEM-H11212



油缸中号扳手 六角螺母扳手
适用机型150-300型
最大长度480mm

YEM-H11213



油缸小号扳手 六角螺母扳手
适用机型60-200型
最大长度380mm

YEM-H11230



AAP 黄油枪 Grease Gun

YEM-H11231



FAG专业重型手动
防爆不锈钢黄油枪

YEM-H11232



FAG专业重型手动
防爆透明黄油枪

YEM-H11233



吹风机

YEM-H11214



油缸大号扳手 圆形螺母扳手
适用机型120-300型
内劲215mm 外径305mm

YEM-H11215



油缸中号扳手 圆形螺母扳手
适用机型35-120型
内劲165mm 外径235mm

YEM-H11216



油缸小号扳手 圆形螺母扳手
适用机型17-60型
内劲150mm 外径200mm

YEM-H11217



油缸活塞扳手
总长: 310mm 把宽: 28mm
把厚: 25mm

YEM-H11234



12V/24V
电动计量柴油加油泵
Power-driver Fuel Pump

YEM-H11235



液压泵测量表

YEM-H11236



4个表 12个接头14个三通

YEM-H11237



5个表 12个接头14个三通

YEM-H11218



打斗齿销器 总高度170mm/
短销长度45mm/圆孔直径14mm/
长销长度86mm/圆孔直径14mm

YEM-H11219



曲轴皮带轮拆安装工具
6BG1/DB58

YEM-H11220



泵泵胆弹簧工具

YEM-H11221



油水分离器扳手

YEM-H11238



破碎锤1号

YEM-H11239



氮气表

YEM-H11240



气瓶减压器 韩宇低压表

YEM-H11241



皮带式

YEM-H11222



YEM-H11223



泵流量扳手

YEM-H11224



泵流量扳手

YEM-H11225



三爪式

YEM-H11242



三爪式

YEM-H11243



装/拆活塞环专用工具

YEM-H11244



A:套筒式黄油嘴扳手
B:两用万向扳手

YEM-H11245



T90 神钢专用

回油管 OIL RETURN TUBE

回油管 OIL RETURN TUBE

YEM-H11246



YEM

喷油咀回油管 DB58

YEM-H11247



YEM

3167-51-7650
6D105增压器进油管 PC200-3

YEM-H11248



YEM

喷油嘴回油管 4BG1

YEM-H11267



YEM

柴油格座柴油回油管 6D114

YEM-H11268



YEM

柴油泵管 6HK1

YEM-H11269



YEM

柴油泵管 4BD1

YEM-H11249



YEM

6D95 增压器进油管 PC200-6

YEM-H11250



YEM

柴油格进油管(长) PC200-7 6D102

YEM-H11251



YEM

柴油格进油管(短) PC200-7 6D102

YEM-H11270



YEM

柴油泵管 4BG1

YEM-H11271



YEM

柴油泵管 J05 23811-EOC60

YEM-H11272



YEM

柴油泵三通管 6HK1

YEM-H11252



YEM

柴油格回油管(两头弯)
PC200-8 6D107 6754-71-9920

YEM-H11253



YEM

增压器进油管 DE08T

YEM-H11254



YEM

柴油格进油管 PC200-8

YEM-H11273



YEM

柴油管 6HK1

YEM-H11274



YEM

柴油泵三通管 4BG1

YEM-H11275



YEM

柴油泵回油管 J05E

YEM-H11255



YEM

增压器进油管 D6E VOLVO210

YEM-H11256



YEM

DB58 增压器进油管
DH220-5 DH220LC-3/2 DH220-7

YEM-H11257



YEM

增压器回油管DE08T

YEM-H11276



YEM

高压泵连接回油管 6HK1

YEM-H11277



YEM

液泵管(4件套) 6HK1

YEM-H11278



YEM

连轴器接连接盘缸体 J08E

YEM-H11258



YEM

YANMAR 洋马 增压器回油管

YEM-H11259



YEM

增压器回油管 DB58 DH220-5

YEM-H11260



YEM

增压器回油管 6D14/15/16

YEM-H11279



YEM

柴油泵三通管 J05

YEM-H11280



YEM

柴油泵连接管 6HK1

YEM-H11281



YEM

液泵M型管 6BG1 4369148

YEM-H11261



YEM

4D95 B3.3 PC120-5/6
PC60-5/6 增压器回油管

YEM-H11262



YEM

增压器回油管 6D114

YEM-H11263



YEM

增压器回油管 B3.9C

YEM-H11282



YEM

液泵管 ZAX YB0000665

YEM-H11283



YEM

液泵Z型管 4HK1 4629372

YEM-H11284



YEM

液泵小弯管 4HK1 4631943

YEM-H11264



YEM

增压器回油管 6D107

YEM-H11265



YEM

柴油泵回油管 J08E

YEM-H11266



YEM

柴油管 4BD1

YEM-H11285



YEM

洋马 液泵小弯管

YEM-H11286



YEM

分配器管 日立

YEM-H11287



YEM

PC200-8 高压共轨管

回油管 OIL RETURN TUBE

YEM-H11288



高压共轨管(直) PC400-7

YEM-H11291



高压共轨管 J05

YEM-H11294



高压共轨管(直) PC400-8

YEM-H11297



共轨泄压阀四通管 6HK1

YEM-H11300



柴油泵回油管 23811-EOC70 J08

YEM-H11303



增压器回水管 J05

YEM-H11306



EGR阀接水泵水管 VH 16332 E0140 J08

YEM-H11289



高压共轨管 4HK1

YEM-H11292



高压共轨管 PC400-7

YEM-H11295



共轨管 D6E

YEM-H11298



直喷发动机管 6HK1

YEM-H11301



进气管接铝托架 VH S237662860 J08

YEM-H11304



增压器进水管J08E

YEM-H11307



柴油格座柴油泵进油管 6D114

YEM-H11290



高压共轨管(弯) PC400-8

YEM-H11293



高压共轨管 SK140-8

YEM-H11296



EGR阀水管(长) J05E

YEM-H11299



EGR阀接缸体水管 VH 16222 E0180 J08

YEM-H11302



水管 J05EGR S1669-13720

YEM-H11305



增压器进水管J05E

YEM-H11308



手油泵进油管 6D114

回油管 OIL RETURN TUBE

YEM-H11309



手油泵改装管(长) 6D114

YEM-H11310



手油泵改装管(短) 6D114

YEM-H11311



柴油泵进油管 6HK1

YEM-H11312



S6K 机体管 CAT200B
CAT320/B/C

YEM-H11313



S6K 缸盖管 CAT200B
CAT320/B/C

YEM-H11314



VOLOV机油尺导管

YEM-H11315



J08E 高压泵三通回油管 SK350-8

YEM-H11316



增压器回水管 4HK1

YEM-H11317



柴油泵连接柴油格管 C6.6/7.1

YEM-H11318



C6.4

YEM-H11319



6D14 高压油管

YEM-H11320



高压油管 DEO8T

YEM-H11321



D6D 高压油管 VOLVO210

YEM-H11322



D6E VOLVO 高压油管

YEM-H11323



D7E VOLVO 高压油管

YEM-H11324



C6.6 高压油管

YEM-H11325



C7.1电喷 高压油管



























YEM-H11326







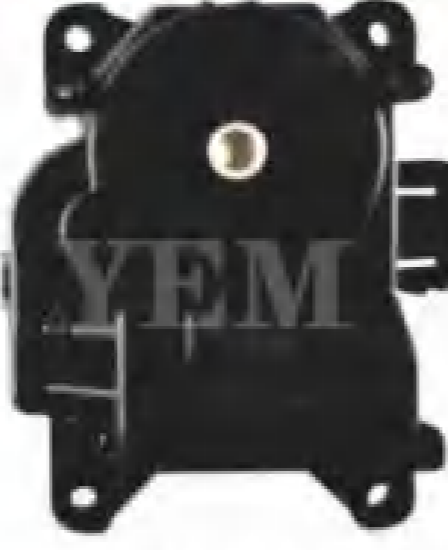



C7.1直喷 高压油管

暖风电机 BLOWER MOTOR
空调系列 AIR CONDITIONING

空调管系列 PIPE TUBE ASSEMBLY

<p>YEM-H11327</p>  <p>SH200 电子风扇</p>	<p>YEM-H11328</p>  <p>卡特 电子风扇 E320GC 510-8095</p>	<p>YEM-H11329</p>  <p>BLOWER MOTOR 268-8792</p>	<p>YEM-H11330</p>  <p>SANY 三一</p>	
<p>YEM-H11331</p>  <p>柳工850</p>	<p>YEM-H11332</p>  <p>斗山 DX-9</p>	<p>YEM-H11333</p>  <p>徐工 新款</p>	<p>YEM-H11334</p>  <p>鼓风电机E306E 5592-1-519709 12V</p>	
<p>YEM-H11335</p>  <p>SK-8温度传感器</p>	<p>YEM-H11336</p>  <p>PC/CAT电装系统</p>	<p>YEM-H11337</p>  <p>三一75/R-9温度传感器</p>	<p>YEM-H11338</p>  <p>大字DH温度传感器</p>	
<p>YEM-H11339</p>  <p>SK-6/DH/凯斯 温度传感器</p>	<p>YEM-H11340</p>  <p>VOLVO温度传感器</p>	<p>YEM-H11341</p>  <p>R215-7/徐工/三一</p>	<p>YEM-H11342</p>  <p>空调温度控制器</p>	
<p>YEM-H11343</p>  <p>日立冷暖 ZAX200502752-292</p>	<p>YEM-H11344</p>  <p>502752-2920</p>	<p>YEM-H11345</p>  <p>R-7内循环</p>	<p>YEM-H11346</p>  <p>R-7模式V5</p>	<p>YEM-H11347</p>  <p>R-7 模式D 2插</p>
<p>YEM-H11348</p>  <p>大字沃尔沃冷暖 220-5 215-7 502752-2910</p>	<p>YEM-H11349</p>  <p>卡特E320C 063700-7200</p>	<p>YEM-H11350</p>  <p>小松 卡特 CAT 063800-0300</p>	<p>YEM-H11351</p>  <p>小松卡特CAT 063600-0310</p>	<p>YEM-H11352</p>  <p>加藤 住友 51502-15080</p>



















<p>YEM-H11353</p>  <p>空调管(低压)DH255-7</p>	<p>YEM-H11354</p>  <p>空调管(低压)R215-7</p>	<p>YEM-H11355</p>  <p>空调管(高压)R215-7</p>	<p>YEM-H11356</p>  <p>空调管(高压)R60</p>
<p>YEM-H11357</p>  <p>空调管(3")R215-7</p>	<p>YEM-H11358</p>  <p>空调管(高压)PC360-6</p>	<p>YEM-H11359</p>  <p>空调管(高压)PC360-7</p>	<p>YEM-H11360</p>  <p>空调管(高压)PC200-8</p>
<p>YEM-H11361</p>  <p>空调管(高压)PC200-7</p>	<p>YEM-H11362</p>  <p>空调管(低压)PC200-7</p>	<p>YEM-H11363</p>  <p>空调管(3")PC200-7</p>	<p>YEM-H11364</p>  <p>空调管(高压)CAT330C</p>
<p>YEM-H11365</p>  <p>空调管(高压新款)DH</p>	<p>YEM-H11366</p>  <p>空调管(3"长)DH55</p>	<p>YEM-H11367</p>  <p>空调管(3"短)DH55</p>	<p>YEM-H11368</p>  <p>空调管(高压)DH55</p>
<p>YEM-H11369</p>  <p>空调管(低压)DH55</p>	<p>YEM-H11370</p>  <p>空调管(中冷高压)CAT320C</p>	<p>YEM-H11371</p>  <p>空调管(高压)CAT320</p>	<p>YEM-H11372</p>  <p>空调管(低压)CAT320C</p>
<p>YEM-H11373</p>  <p>空调管(高压)CAT320D</p>	<p>YEM-H11374</p>  <p>空调管(高压)CAT330D</p>	<p>YEM-H11375</p>  <p>空调管(低压)DH220-5</p>	<p>YEM-H11376</p>  <p>空调管(高压)DH220-5</p>

空调管系列 PIPE TUBE ASSEMBLY

连接胶系列 COUPLING SERIES

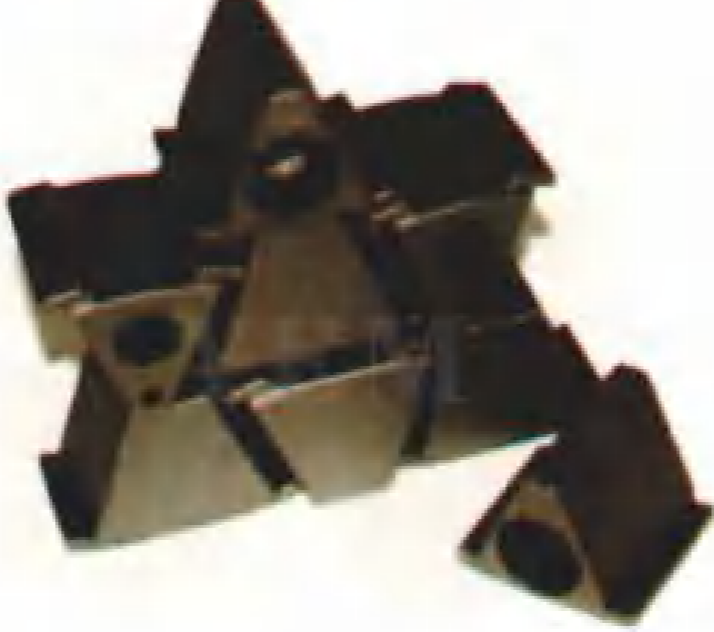
<p>YEM-H11377</p>  <p>空调管(小口高压)日立EX</p>	<p>YEM-H11378</p>  <p>空调管(小口低压)日立EX</p>	<p>YEM-H11379</p>  <p>空调管(大口3")日立EX</p>	<p>YEM-H11380</p>  <p>空调管(大口高压)日立 EX</p>
<p>YEM-H11381</p>  <p>空调管(大口低压)日立EX</p>	<p>YEM-H11382</p>  <p>空调管(大口3")日立EX</p>	<p>YEM-H11383</p>  <p>空调管(高压) VOLVO</p>	<p>YEM-H11384</p>  <p>空调管(低压)VOLVO</p>
<p>YEM-H11385</p>  <p>空调管(3"长) VOLVO</p>	<p>YEM-H11386</p>  <p>空调管(3"短)VOLVO</p>	<p>YEM-H11387</p>  <p>空调管(低压)神钢 SK</p>	<p>YEM-H11388</p>  <p>空调管(高压) 神钢 SK</p>
<p>YEM-H11389</p>  <p>空调管(高压)R215-9</p>	<p>YEM-H11390</p>  <p>空调管(低压)R215-9</p>	<p>YEM-H11391</p>  <p>空调管(高压)PC200-6</p>	<p>YEM-H11392</p>  <p>空调管(3")PC200-6</p>
<p>YEM-H11393</p>  <p>空调管(低压)PC200-6</p>	<p>YEM-H11394</p>  <p>空调管(高压)SK200-8</p>	<p>YEM-H11395</p>  <p>空调管(高压)DH300-7</p>	<p>YEM-H11396</p>  <p>空调管(3")DH300-7</p>
<p>YEM-H11397</p>  <p>空调管(低压)DH300-7</p>	<p>YEM-H11398</p>  <p>空调管(高压)DH60</p>	<p>YEM-H11399</p>  <p>空调管(3")DH225-7</p>	<p>YEM-H11400</p>  <p>空调管(高压)DH225-7</p>





<p>YEM-H11401</p>  <p>130H连接胶总成</p>	<p>YEM-H11402</p>  <p>VOLVO700连接胶总成</p>	<p>YEM-H11403</p>  <p>S25S</p>	<p>YEM-H11404</p>  <p>S29S</p>
<p>YEM-H11405</p>  <p>S32S</p>	<p>YEM-H11406</p>  <p>314X6T</p>	<p>YEM-H11407</p>  <p>198X50T</p>	<p>YEM-H11408</p>  <p>200X4T</p>
<p>YEM-H11409</p>  <p>200X4T</p>	<p>YEM-H11410</p>  <p>245X50T</p>	<p>YEM-H11411</p>  <p>260X46T</p>	<p>YEM-H11412</p>  <p>262X50T 74MM</p>
<p>YEM-H11413</p>  <p>262X42T</p>	<p>YEM-H11414</p>  <p>三一75</p>	<p>YEM-H11415</p>  <p>山猫专业 150X50T</p>	<p>YEM-H11416</p>  <p>徐工150/135</p>
<p>YEM-H11417</p>  <p>徐工75</p>	<p>YEM-H11418</p>  <p>198X50T</p>	<p>YEM-H11419</p>  <p>连接盘总成 徐工150</p>	<p>YEM-H11420</p>  <p>VOLVO7001800 500K</p>



























<p>YEM-H11421</p>  <p>25H 圆</p>	<p>YEM-H11422</p>  <p>500H</p>	<p>YEM-H11423</p>  <p>16H</p>	<p>YEM-H11424</p>  <p>25H</p>
<p>YEM-H11425</p>  <p>30H</p>	<p>YEM-H11426</p>  <p>35H</p>	<p>YEM-H11427</p>  <p>40H</p>	<p>YEM-H11428</p>  <p>45H</p>
<p>YEM-H11429</p>  <p>50H</p>	<p>YEM-H11430</p>  <p>90H</p>	<p>YEM-H11431</p>  <p>110H</p>	<p>YEM-H11432</p>  <p>160H</p>
<p>YEM-H11433</p>  <p>140H</p>	<p>YEM-H11434</p>  <p>240H</p>	<p>YEM-H11435</p>  <p>25H 圆铝</p>	<p>YEM-H11436</p>  <p>50K 铝</p>
<p>YEM-H11437</p>  <p>110K</p>	<p>YEM-H11438</p>  <p>160K</p>	<p>YEM-H11439</p>  <p>240K 铝</p>	<p>YEM-H11440</p>  <p>500H 铝</p>

<p>YEM-H11441</p>  <p>D53 DET308-24-6274 24T</p>	<p>YEM-H11442</p>  <p>D68 D61 D65 DET352-22-6363 22T 134-12-61131</p>	<p>YEM-H11443</p>  <p>D41A D41E-6 DET352-16-6372 16T 124-12-51141</p>	<p>YEM-H11444</p>  <p>D31 D37 DET336-16-6202 16T 113-12-42201</p>
<p>YEM-H11445</p>  <p>PW150-6 PW130-6</p>	<p>YEM-H11446</p>  <p>354X6T</p>	<p>YEM-H11447</p>  <p>465X12T</p>	<p>YEM-H11448</p>  <p>DX60</p>
<p>YEM-H11449</p>  <p>约翰迪尔 352X6T</p>	<p>YEM-H11450</p>  <p>福田60 180X13T 连接盘</p>	<p>YEM-H11451</p>  <p>福田60 180X14T 连接盘</p>	<p>YEM-H11452</p>  <p>福田60 180X15T 连接盘</p>
<p>YEM-H11453</p>  <p>阿特拉斯 ATLAS</p>	<p>YEM-H11454</p>  <p>314X46T</p>	<p>YEM-H11455</p>  <p>352X46T</p>	<p>YEM-H11456</p>  <p>寿力550</p>
<p>YEM-H11457</p>  <p>240X12T</p>	<p>YEM-H11458</p>  <p>240X24T</p>	<p>YEM-H11459</p>  <p>260X24T</p>	<p>YEM-H11460</p>  <p>270X24T</p>

连接器系列 CONNECTOR SERIES

联轴器系列 COUPLING SERIES

YEM-H11461  290X24T	YEM-H11462  295X24T	YEM-H11463  330X16T	YEM-H11464  330X24T
YEM-H11465  390X24T	YEM-H11466  395X24T	YEM-H11467  400X24T	YEM-H11468  405X24T
YEM-H11469  405X24T	YEM-H11470  405X24T	YEM-H11471  440X24T	YEM-H11472  428X24T
YEM-H11473  443X24T	YEM-H11474  445X24T	YEM-H11475  3500	YEM-H11476  665-24T
YEM-H11477  440-24T	YEM-H11478  440-24T	YEM-H11479  440-24T	YEM-H11480  XCMG

YEM-H11481  外齿46X12齿X齿对齿30X 54高	YEM-H11482  外齿46X14齿X齿对齿35 X 64高	YEM-H11483  外齿46X14齿X齿对齿35 X 54高	YEM-H11484  外齿46X17齿X齿对齿42X 58高	
YEM-H11485  外齿50X14齿X齿对齿35X63高	YEM-H11486  外齿50X14齿X齿对齿35X 53高	YEM-H11487  外齿50X14齿X齿对齿28 X 63高	YEM-H11488  外齿50X14齿X齿对齿28 X 53高	
YEM-H11489  外齿42X 13齿X齿对齿19X55高	YEM-H11490  外齿42X 15齿X齿对齿22X55高	YEM-H11491  齿对齿28X55高	YEM-H11492  外齿42X 14齿X齿对齿35 X 55高	
YEM-H11493  外齿50X13齿X齿对齿19X44高	YEM-H11494  外齿50X14齿X齿对齿28 X 44高	YEM-H11495  外齿50X 15齿X齿对齿22 X 44高	YEM-H11496  13齿X齿对齿19X44高	
YEM-H11497  外齿47X15齿齿对齿22X 44高	YEM-H11498  外齿47X14齿X齿对齿28X44高	YEM-H11499  外齿46X14齿X齿对齿28X54高	YEM-H11500  外齿46X 13齿X齿对齿45X70高	YEM-H11501  外齿46X15齿X齿对齿50X65高
YEM-H11502  齿35X52高	YEM-H11503  外齿48X13X齿对齿45 X65高	YEM-H11504  外齿48X17齿X齿对齿42X65高	YEM-H11505  外齿54 X15齿X齿对齿45X72高	YEM-H11506  外齿54X 17齿X齿对齿42X72高

联轴器系列 COUPLING SERIES

喇叭盘 TRUMPET PLATE
平行胶 PARALLEL GLUE

























YEM-H11507  外齿4X14齿X齿对齿28X55高	YEM-H11508  外齿4X15齿X齿对齿22X42高	YEM-H11509  外齿8X17齿X齿对齿42X58高	YEM-H11510  外齿4X13齿X齿对齿19X44高	YEM-H11511  (缺3个齿、山猫专用) 外齿50X14齿X齿对齿28X44高
YEM-H11512  (缺3个齿) 外齿46X15齿X齿对齿50X65高	YEM-H11513  (缺3个齿) 外齿46X17齿X齿对齿42X58高	YEM-H11514  外齿48X24齿X齿对齿46X64高	YEM-H11515  外齿50X24齿X齿对齿46X53高	YEM-H11516  外齿26X13齿
YEM-H11517  外齿26X14齿	YEM-H11518  外齿26X15齿	YEM-H11519  外齿8X15齿高	YEM-H11520  外齿8X15齿矮	YEM-H11521  外齿8X13齿高
YEM-H11522  外齿8X14齿高	YEM-H11523  外齿47X15齿X齿对齿22X56高	YEM-H11524  外齿42X14齿X齿对齿39X49高	YEM-H11525  外齿6X14齿 徐工150专用	YEM-H11526  外齿46X17齿X齿对齿42X65高
YEM-H11527  外齿46X17齿X齿对齿42X70高	YEM-H11528  外齿50X15齿X齿对齿36X53高	YEM-H11529  外齿48X21齿X齿对齿40.5/45.5X58高	YEM-H11530  外齿48X24齿X齿对齿46.5/51X110高	YEM-H11531  外齿54X24齿X齿对齿46.5/51X76高
YEM-H11532  外齿48X14齿X齿对齿30.5/35X53高	YEM-H11533  外齿12X18齿X齿对齿54.5*60X62高	YEM-H11534  外齿8X17齿X齿对齿42*47X82高	YEM-H11535  外齿46X21齿X齿对齿45X60高	YEM-H11536  外齿42X21齿X齿对齿45X55高























YEM-H11537  K3V112 平24孔	YEM-H11538  K3V112 加厚平	YEM-H11539  K3V112 凸加厚	YEM-H11540  K3V112 平外490
YEM-H11541  K3V112 凸外490	YEM-H11542  K3V140 外490加厚	YEM-H11543  K3V1140凸外490 加厚	YEM-H11544  K3V180加厚
YEM-H11545  K3V63 加大外450	YEM-H11546  K3V63 加厚小外410	YEM-H11547  K3V63 SH 外450	YEM-H11548  K5V200 550M 高
YEM-H11549  K5V200加厚	YEM-H11550  SH200 加厚	YEM-H11551  ZAX50/55/60 两孔缺边	YEM-H11552  ZAX110/120 四孔缺边
YEM-H11553  ZAX60/70 原装2孔	YEM-H11554  E120B 喇叭盘	YEM-H11555  6D108 平衡块	YEM-H11556  平衡块 H370/420/500
YEM-H11557  平衡块VOLVO210/D6D/D6E	YEM-H11558  平衡块VOLVO290/D7D/D7E	YEM-H11559  平衡块 J08E	YEM-H11560  平衡块6HK1 ZAX330-3



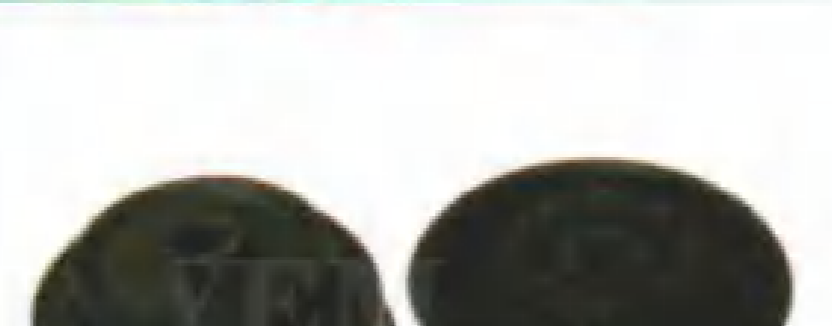

机脚胶 ENGINE CUSHION

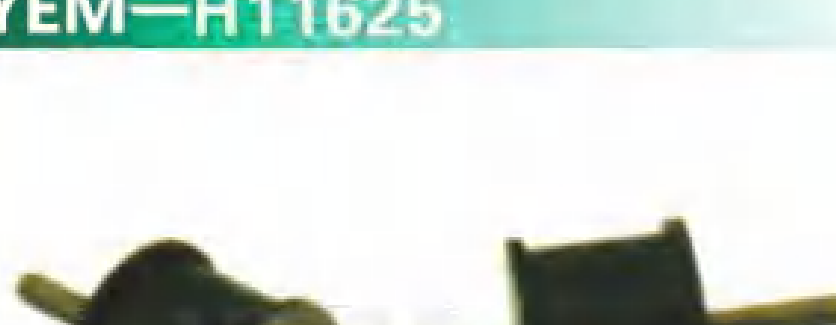
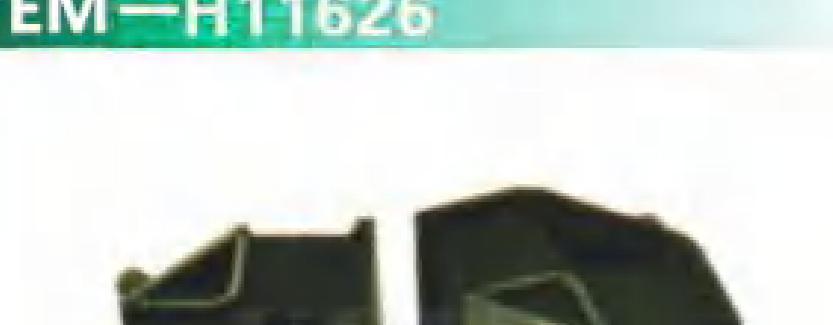
<p>YEM-H11561</p>  <p>PC130-7 前</p>	<p>YEM-H11562</p>  <p>PC130-7 后</p>	<p>YEM-H11563</p>  <p>PC300-3/5/6 前</p>	<p>YEM-H11564</p>  <p>PC300-3/5/6 后</p>
<p>YEM-H11565</p>  <p>PC400-6/400-7/1450-7</p>	<p>YEM-H11566</p>  <p>PC600/700/800 前</p>	<p>YEM-H11567</p>  <p>PC600/700/800 后</p>	<p>YEM-H11568</p>  <p>E320D</p>
<p>YEM-H11569</p>  <p>E320D2</p>	<p>YEM-H11570</p>  <p>E345/349B/C/D</p>	<p>YEM-H11571</p>  <p>E375B/C/D 前</p>	<p>YEM-H11572</p>  <p>E375B/C/D 后</p>
<p>YEM-H11573</p>  <p>E330D</p>	<p>YEM-H11574</p>  <p>SK09</p>	<p>YEM-H11575</p>  <p>SK60-5/6/7</p>	<p>YEM-H11576</p>  <p>SK75-8 前</p>
<p>YEM-H11577</p>  <p>SK75-8 后</p>	<p>YEM-H11578</p>  <p>SK460-8 前</p>	<p>YEM-H11579</p>  <p>SK460-8 后</p>	<p>YEM-H11580</p>  <p>SH60 圆</p>

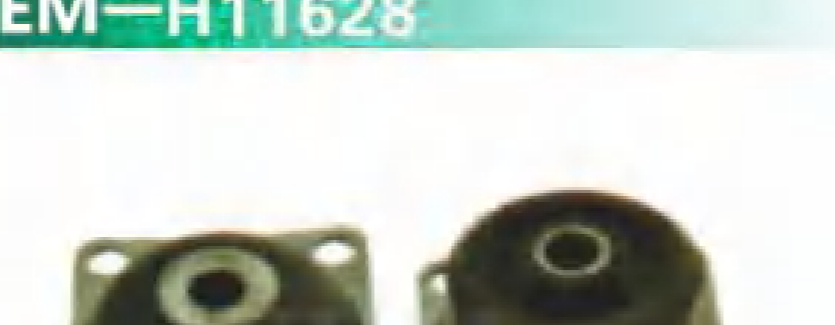
机脚胶 ENGINE CUSHION







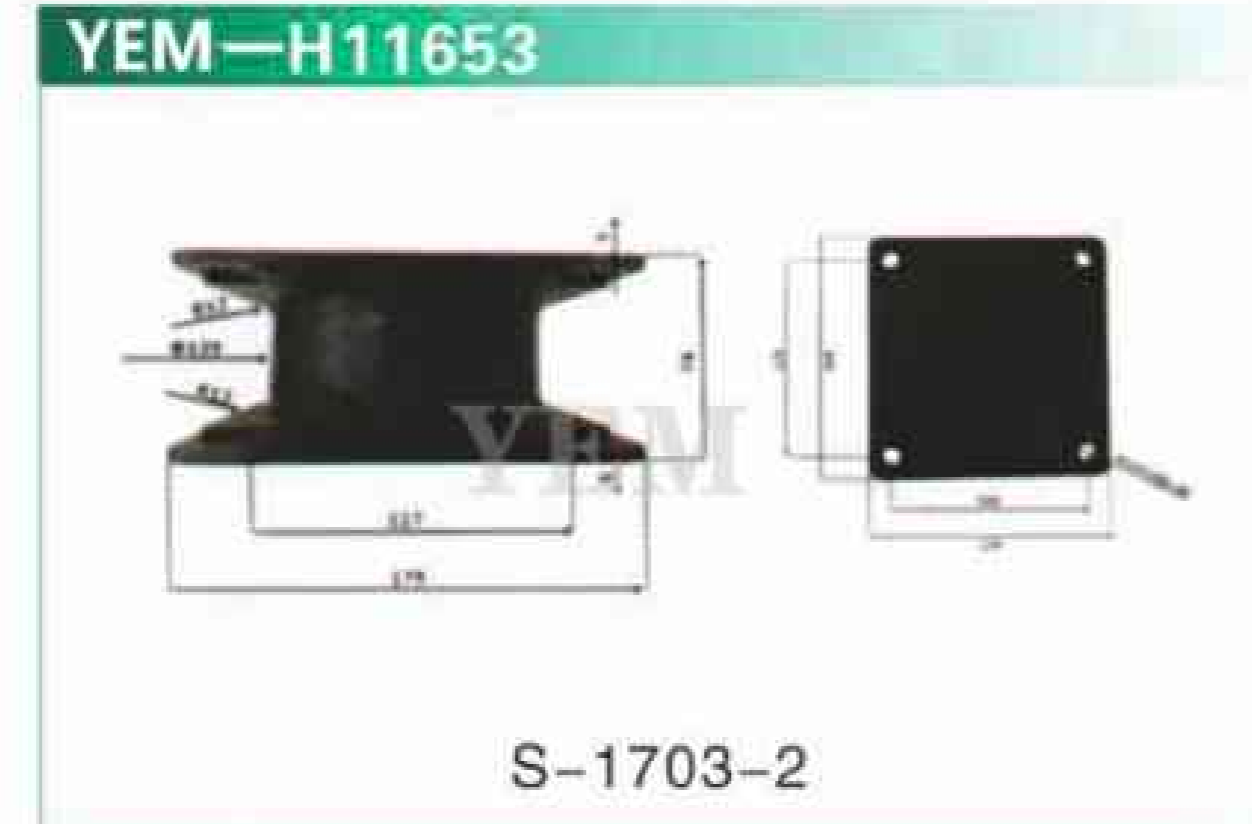
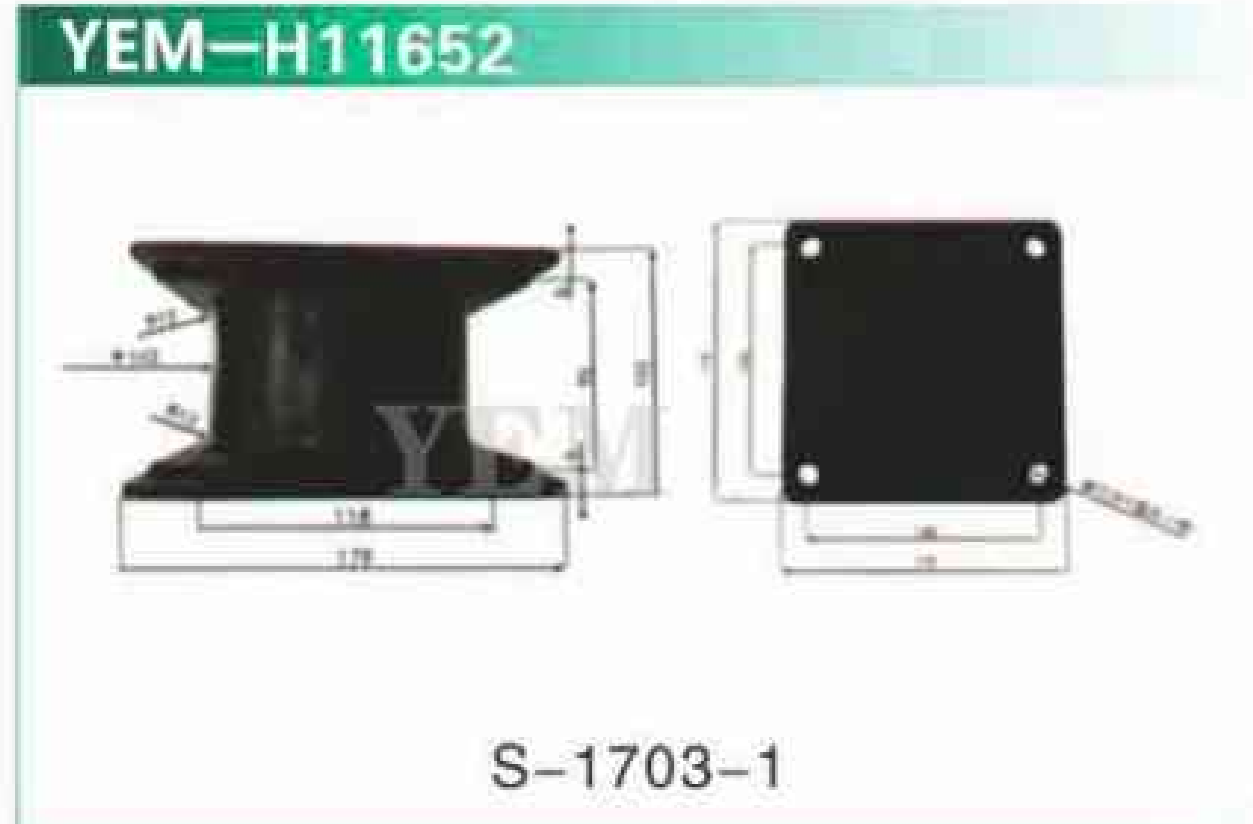



<p>YEM-H11581</p>  <p>SH60(三角形)</p>	<p>YEM-H11582</p>  <p>SH265/260</p>	<p>YEM-H11583</p>  <p>SH300A1/A2/A3</p>	<p>YEM-H11584</p>  <p>SH350-5/450-5</p>
<p>YEM-H11585</p>  <p>SH400-6</p>	<p>YEM-H11586</p>  <p>ZAXIS450</p>	<p>YEM-H11587</p>  <p>ZAX450方</p>	<p>YEM-H11588</p>  <p>ZAX470</p>
<p>YEM-H11589</p>  <p>ZAXIS470 后</p>	<p>YEM-H11590</p>  <p>R55-7</p>	<p>YEM-H11591</p>  <p>R60/60-5</p>	<p>YEM-H11592</p>  <p>R60-7/80-7</p>
<p>YEM-H11593</p>  <p>R225-7</p>	<p>YEM-H11594</p>  <p>R305-7</p>	<p>YEM-H11595</p>  <p>R380-9T/R455</p>	<p>YEM-H11596</p>  <p>R455/500-9</p>
<p>YEM-H11597</p>  <p>DH60-7</p>	<p>YEM-H11598</p>  <p>DH70</p>	<p>YEM-H11599</p>  <p>DH80-7</p>	<p>YEM-H11600</p>  <p>DH80-9</p>
<p>YEM-H11601</p>  <p>DH130-7前</p>	<p>YEM-H11602</p>  <p>DH130-7后</p>	<p>YEM-H11603</p>  <p>DH225-7</p>	<p>YEM-H11604</p>  <p>DH300-5 前</p>

<p>YEM-H11605</p>  <p>DH300-7 后</p>	<p>YEM-H11606</p>  <p>DH300-7 前</p>	<p>YEM-H11607</p>  <p>DH250/370 前</p>	<p>YEM-H11608</p>  <p>DH370-7/420 前</p>
<p>YEM-H11609</p>  <p>DH370-7/420 后</p>	<p>YEM-H11610</p>  <p>DH500-7 土豪金</p>	<p>YEM-H11611</p>  <p>DX380-9C</p>	<p>YEM-H11612</p>  <p>EC55/60/140</p>
<p>YEM-H11613</p>  <p>EC210B</p>	<p>YEM-H11614</p>  <p>VOLVO140</p>	<p>YEM-H11615</p>  <p>VOLVO360/380 前</p>	<p>YEM-H11616</p>  <p>VOLVO360/380 后</p>
<p>YEM-H11617</p>  <p>VOLVO600/700/800 前</p>	<p>YEM-H11618</p>  <p>VOLVO600/700/800 后</p>	<p>YEM-H11619</p>  <p>国产13厘</p>	<p>YEM-H11620</p>  <p>国产17厘</p>
<p>YEM-H11621</p>  <p>YC13</p>	<p>YEM-H11622</p>  <p>YC85/135-8 前</p>	<p>YEM-H11623</p>  <p>YC85/135-8 后</p>	<p>YEM-H11624</p>  <p>石川岛 细</p>
<p>YEM-H11625</p>  <p>石川岛 大</p>	<p>YEM-H11626</p>  <p>石川岛 大</p>	<p>YEM-H11627</p>  <p>小挖/洋马 三角形(小)</p>	<p>YEM-H11628</p>  <p>山河智能70 四孔</p>





















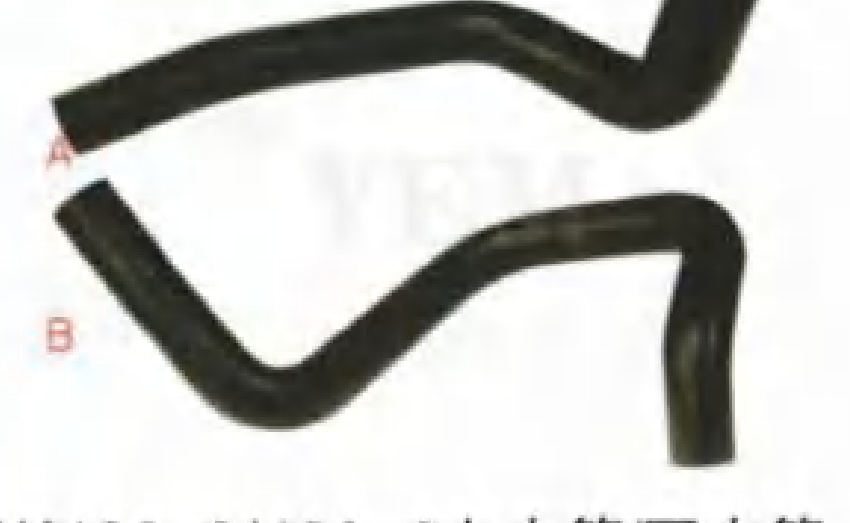

<p>YEM-H11629</p>  <p>EA-85</p>	<p>YEM-H11630</p>  <p>EA-120</p>	<p>YEM-H11631</p>  <p>EA-220</p>	<p>YEM-H11632</p>  <p>EA-300</p>
<p>YEM-H11633</p>  <p>久保田</p>	<p>YEM-H11634</p>  <p>力士德210</p>	<p>YEM-H11635</p>  <p>柳工920</p>	<p>YEM-H11636</p>  <p>徐控200-7</p>
<p>YEM-H11637</p>  <p>徐工335前</p>	<p>YEM-H11638</p>  <p>徐工335后</p>	<p>YEM-H11639</p>  <p>徐工235 前</p>	<p>YEM-H11640</p>  <p>徐工235 后</p>
<p>YEM-H11641</p>  <p>厦工822后</p>	<p>YEM-H11642</p>  <p>震宇80</p>	<p>YEM-H11643</p>  <p>小箱/圆</p>	<p>YEM-H11644</p>  <p>小箱/方</p>
<p>YEM-H11645</p>  <p>三一15/16</p>	<p>YEM-H11646</p>  <p>三一75 专用</p>	<p>YEM-H11647</p>  <p>三一135/215/235/335-8</p>	<p>YEM-H11648</p>  <p>三一485 6D22 前</p>
<p>YEM-H11649</p>  <p>三一485 6D22 后</p>	<p>YEM-H11650</p>  <p>洋马20</p>	<p>YEM-H11651</p>  <p>小挖 洋马</p>	









水管 HOSE

<p>YEM-H11685</p>  <p>PC20 上水管/下水管</p>	<p>YEM-H11686</p>  <p>PC30 上水管/下水管</p>	<p>YEM-H11687</p>  <p>PC40MR-2 上水管/下水管</p>	<p>YEM-H11688</p>  <p>PC40R-8 上水管/下水管</p>
<p>YEM-H11689</p>  <p>PC56-7 上水管/下水管</p>	<p>YEM-H11690</p>  <p>PC70-8 上水管/下水管</p>	<p>YEM-H11691</p>  <p>PC750/850 上水管/中水管/下水管</p>	<p>YEM-H11692</p>  <p>E70B 上水管下水管</p>
<p>YEM-H11693</p>  <p>E120 上水管/中水管/下水管</p>	<p>YEM-H11694</p>  <p>E305 下水管</p>	<p>YEM-H11695</p>  <p>E307D 上水管/下水管</p>	<p>YEM-H11696</p>  <p>E308C 上水管/下水管</p>
<p>YEM-H11697</p>  <p>E312D 上水管/下水管</p>	<p>YEM-H11698</p>  <p>E315D 上水管下水管</p>	<p>YEM-H11699</p>  <p>E320D 上水管/下水管</p>	<p>YEM-H11700</p>  <p>E325C 上水管/下水管</p>
<p>YEM-H11701</p>  <p>E330D 上水管/下水管</p>	<p>YEM-H11702</p>  <p>E345D 上水管/中水管/下水管</p>	<p>YEM-H11703</p>  <p>EX60-1 上水管/下水管</p>	<p>YEM-H11704</p>  <p>EX60-3 上水管/下水管</p>







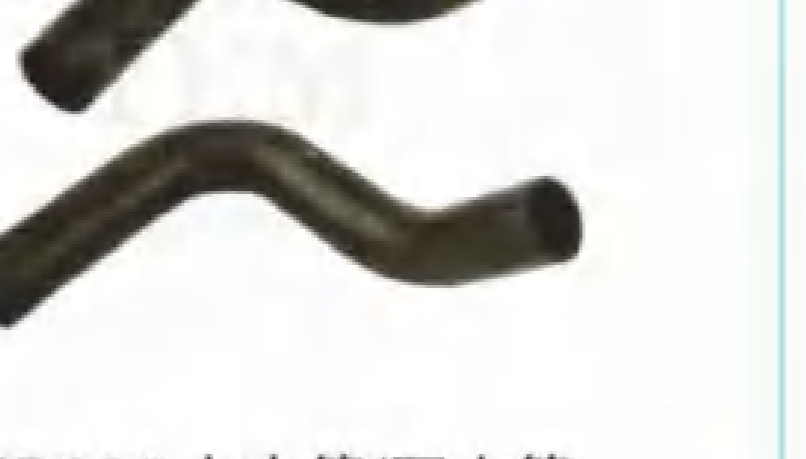







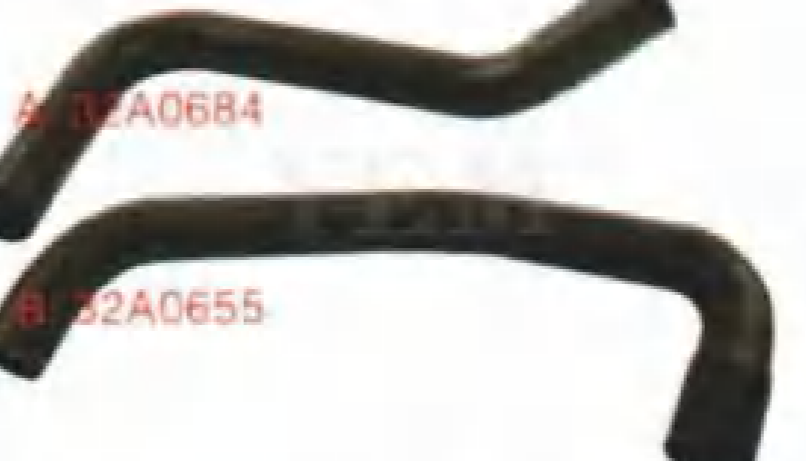





水管 HOSE

<p>YEM-H11705</p>  <p>EX100-1 上水管/下水管</p>	<p>YEM-H11706</p>  <p>EX400-1 上水管/下水管</p>	<p>YEM-H11707</p>  <p>ZAX55 上水管/下水管</p>	<p>YEM-H11708</p>  <p>ZAX130/135 上水管/下水管</p>
<p>YEM-H11709</p>  <p>ZAX330-1 上水管/下水管(直喷)</p>	<p>YEM-H11710</p>  <p>ZAX330-3 上水管/下水管(电喷)</p>	<p>YEM-H11711</p>  <p>ZAX450 上水管/下水管(直喷)</p>	<p>YEM-H11712</p>  <p>ZAX470 上水管下水管(电喷)</p>
<p>YEM-H11713</p>  <p>SK60 上水管/下水管</p>	<p>YEM-H11714</p>  <p>SK07N2 上水管/下水管</p>	<p>YEM-H11715</p>  <p>SK135-8 上水管/下水管</p>	<p>YEM-H11716</p>  <p>SK460-8/480-8 上水管/下水管</p>
<p>YEM-H11717</p>  <p>DH80-7 上水管/中水管/下水管</p>	<p>YEM-H11718</p>  <p>DH80-9 上水管/中水管/下水管</p>	<p>YEM-H11719</p>  <p>DH130 上水管/下水管</p>	<p>YEM-H11720</p>  <p>DH220-3 上水管/下水管</p>
<p>YEM-H11721</p>  <p>DH225-9 上水管/中水管下水管</p>	<p>YEM-H11722</p>  <p>DH360-5 上水管/下水管</p>	<p>YEM-H11723</p>  <p>DH370-7 上水管/下水管</p>	<p>YEM-H11724</p>  <p>DH370-9 上水管/中水管/下水管</p>
<p>YEM-H11725</p>  <p>DX60 上水管下水管</p>	<p>YEM-H11726</p>  <p>DX150 上水管下水管</p>	<p>YEM-H11727</p>  <p>DX225 上水管/中水管/下水管</p>	<p>YEM-H11728</p>  <p>DX260 上水管/中水管/下水管</p>

水管 HOSE

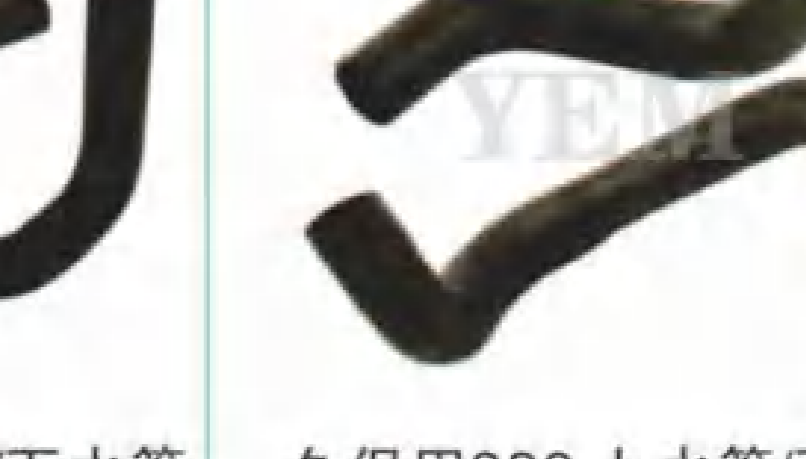
<p>YEM-H11729</p>  <p>DX380 上水管/中水管/下水管</p>	<p>YEM-H11730</p>  <p>VOLVO140 上水管/中水管/下水管</p>	<p>YEM-H11731</p>  <p>R55 上水管/下水管</p>	<p>YEM-H11732</p>  <p>R60-7 上水管/下水管</p>
<p>YEM-H11733</p>  <p>R150-7 上水管/下水管</p>	<p>YEM-H11734</p>  <p>R215-9 上水管下水管(NEW)</p>	<p>YEM-H11735</p>  <p>R225-9T 上水管/下水管</p>	<p>YEM-H11736</p>  <p>R265-9 上水管/下水管</p>
<p>YEM-H11737</p>  <p>R275-9T 上水管/中水管/下水管</p>	<p>YEM-H11738</p>  <p>R290 上水管/下水管</p>	<p>YEM-H11739</p>  <p>R290-7 上水管/下水管</p>	<p>YEM-H11740</p>  <p>R305-7 上水管/下水管</p>
<p>YEM-H11741</p>  <p>R275-9T 上水管/中水管/下水管</p>	<p>YEM-H11742</p>  <p>R335-9T 上水管/下水管</p>	<p>YEM-H11743</p>  <p>R385-9T 上水管/下水管</p>	<p>YEM-H11744</p>  <p>R420/450/500上水管/下水管</p>
<p>YEM-H11745</p>  <p>SH60 上水管/下水管</p>	<p>YEM-H11746</p>  <p>SH200A1 上水管/下水管</p>	<p>YEM-H11747</p>  <p>SH210-5 上水管/下水管</p>	<p>YEM-H11748</p>  <p>SH300 上水管下水管</p>
<p>YEM-H11749</p>  <p>SH350-5 上水管/下水管</p>	<p>YEM-H11750</p>  <p>HD800-5 上水管/中水管/下水管</p>	<p>YEM-H11751</p>  <p>HD900 上水管/下水管</p>	<p>YEM-H11752</p>  <p>HD1430-3 上水管/下水管</p>

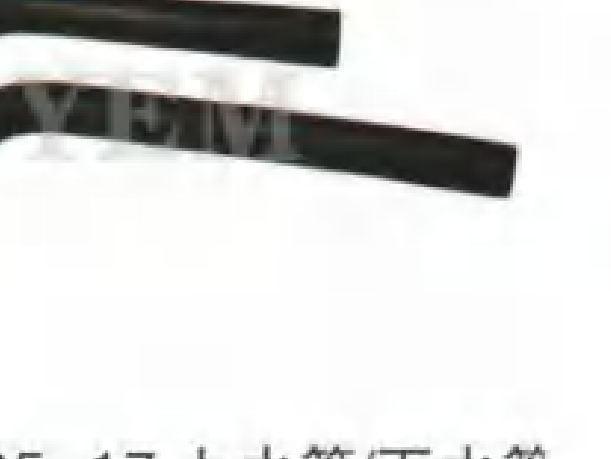
水管 HOSE

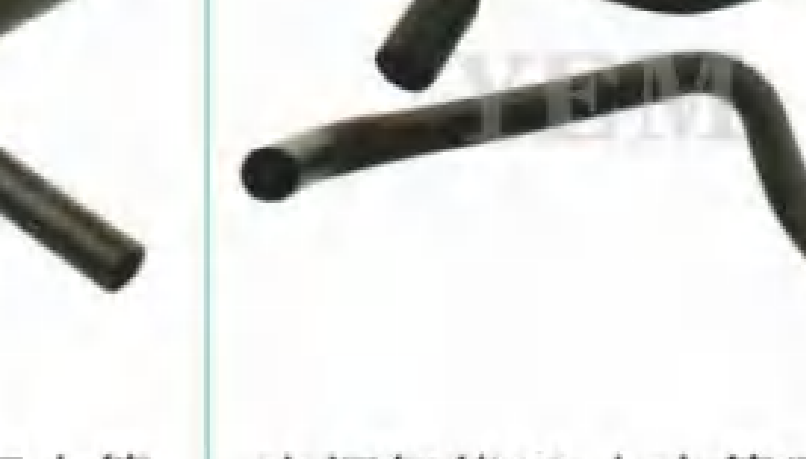
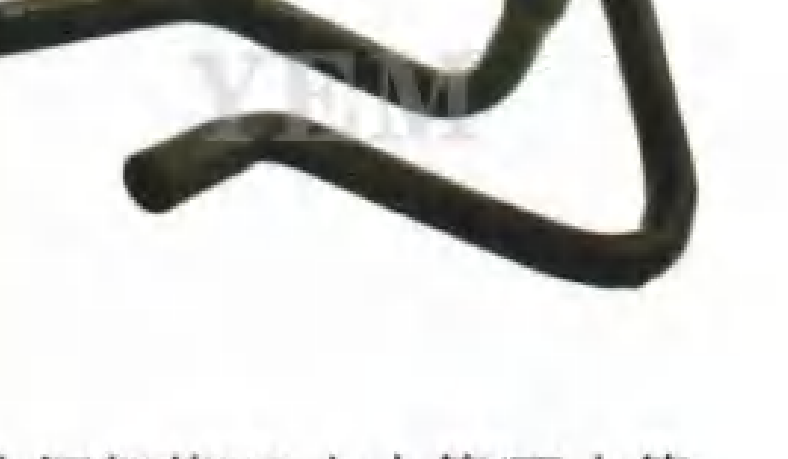
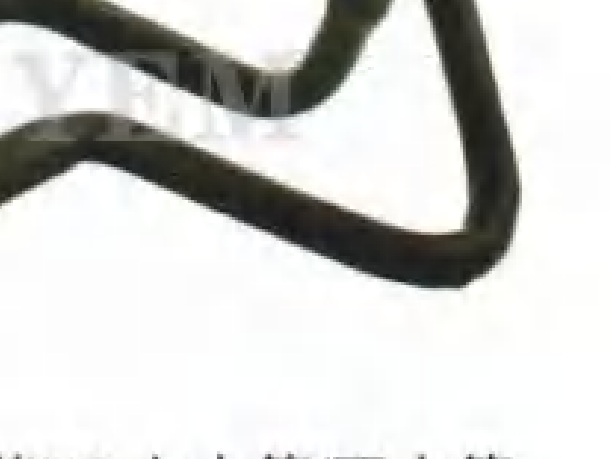
<p>YEM-H11753</p> <p>A: 32A0306 B: 32A0306</p>  <p>柳工906 上水管/下水管</p>	<p>YEM-H11754</p> <p>A: 32A0347 B: 30A0374</p>  <p>柳工908 上水管/下水管</p>	<p>YEM-H11755</p> <p>A: 32A0375 B: 32A0365</p>  <p>柳工915C 上水管/下水管</p>	<p>YEM-H11756</p> <p>A: 32A0336 B: 32A0332</p>  <p>柳工915D 上水管/下水管</p>	
<p>YEM-H11757</p> <p>A: 32A0684 B: 32A0784</p>  <p>柳工920D 上水管/下水管</p>	<p>YEM-H11758</p> <p>A: 32A0684 B: 32A0655</p>  <p>柳工925D 上水管/下水管</p>	<p>YEM-H11759</p> <p>A: 32A0724 B: 32A0747</p>  <p>柳工936C 上水管/下水管</p>	<p>YEM-H11760</p> <p>A: 32A0162 B: 32A0368</p>  <p>柳工220 上水管/下水管</p>	
<p>YEM-H11761</p> <p>A: 32A0162 B: 32A0368</p>  <p>柳工225上水管/下水管</p>	<p>YEM-H11762</p> <p>A: 40-40-330 B: 37-37-410</p>  <p>SY55C 上水管下水管</p>	<p>YEM-H11763</p> <p>A: 40-45-250 B: 40-45-270</p>  <p>SY65/75 上水管/下水管(OLD)</p>	<p>YEM-H11764</p> <p>A: 38-45-250 B: 38-45-380</p>  <p>SY65/75 上水管/下水管(NEW)</p>	
<p>YEM-H11765</p>  <p>SY215-7C上水管/中水管/下水管</p>	<p>YEM-H11766</p>  <p>SY225-8 上水管/下水管</p>	<p>YEM-H11767</p>  <p>徐工60/65 上水管/中水管/下水管</p>	<p>YEM-H11768</p>  <p>徐工130/150 上水管/下水管</p>	
<p>YEM-H11769</p>  <p>徐工210/230 上水管/下水管</p>	<p>YEM-H11770</p>  <p>久保田55 上水管/下水管</p>	<p>YEM-H11771</p>  <p>久保田155 上水管/下水管</p>	<p>YEM-H11772</p>  <p>久保田380 上水管/下水管</p>	<p>YEM-H11773</p>  <p>久保田D5-17 上水管/下水管</p>
<p>YEM-H11774</p>  <p>YC85-6 上水管/下水管</p>	<p>YEM-H11775</p>  <p>YC85-8 上水管/中水管/下水管</p>	<p>YEM-H11776</p>  <p>山河智能50 上水管/下水管</p>	<p>YEM-H11777</p>  <p>山河智能60 上水管/下水管</p>	<p>YEM-H11778</p>  <p>山河智能70 上水管/下水管</p>

耐油管 OIL PIPE

分水管 WATER PIPE

YEM-H11779



PC40 Φ42

YEM-H11780



PC40 Φ45

YEM-H11781



PC40 Φ50

YEM-H11782



PC200-7

YEM-H11783



SK120-5/6

YEM-H11784



SK60-7 50MMX50MM

YEM-H11785



SK120-6 U形管

YEM-H11786



SK135-88 LS30H01045P1 液压油管

YEM-H11787



SK200-6

YEM-H11788



SK200-8

YEM-H11789



SK250-8

YEM-H11790



SK320-6

YEM-H11791



SK350-8

YEM-H11792



SK460-8 LS30H0119P1 液压油管

YEM-H11793



HD820-3

YEM-H11794



HD1430-3 60MMX60MM

YEM-H11795



ZAXIS450

YEM-H11796



R55-7

YEM-H11797



Φ22*1100 Φ35*1100 Φ48*1100 Φ70*1100
 Φ95*1100 Φ25*1100 Φ38*1100 Φ50*1100
 Φ75*1100 Φ40*1100 Φ55*1100 Φ100*1100
 Φ28*1100 Φ80*1100 Φ110*1100 Φ30*1100
 Φ42*1100 Φ60*1100 Φ85*1100 Φ32*1100
 Φ45*1100 Φ65*1100 Φ90*1100

YEM-H11798



PC200-3 分水管

YEM-H11799



6D16 分水管

YEM-H11800



6D95 分水管

YEM-H11801



6D102

YEM-H11802



6D105 分水管

YEM-H11803



6BG1

YEM-H11804



DH220-5/7/9 分水管(1)

YEM-H11805



DH220-5/7/9 分水管(2)

YEM-H11806



DH300-5/7/9 分水管

YEM-H11807



DH300 Φ45 分水管

YEM-H11808



SH300

YEM-H11809



4BD1

YEM-H11810



6BD1

YEM-H11811



S6K

YEM-H11812



SK60 SH60

YEM-H11813



SK60SR/70SR C4JB17

YEM-H11814



R305-7 分水管

YEM-H11815



R375 分水管

YEM-H11816



J05EGR 分水管

YEM-H11817



6HK1 分水管

YEM-H11818



4HK1 分水管

分水管 WATER PIPE

进气管 AIRDUST HOSE

YEM-H11819



VOLVO240/290 分水管

YEM-H11820



VOLVO210 U型 分水管

YEM-H11821



VOLVO360 分水管

YEM-H11822



SY335 分水管

YEM-H11823



SY465 分水管

YEM-H11824



6D22 分水管

YEM-H11825



废气管 4HK1

YEM-H11826



废气管 6HK1

YEM-H11827



废气管 C7

YEM-H11828



废气管 C9

YEM-H11829



废气管 C6.4

YEM-H11830



废气管 4D31

YEM-H11831



废气管 4M40

YEM-H11832



废气管 DH370

YEM-H11833



废气管 DB58

YEM-H11834



废气管 S6K

YEM-H11835



下废气管 DH55 大/小

YEM-H11836



HD 6D34 下废气管

YEM-H11837



下废气管 S4K

YEM-H11838



下废气管 S6K

YEM-H11839



柴油管
4mm 6mm 8mm 10mm
12mm 14mm 16mm

YEM-H11840



空气管
E320B E8200 1500/1700

YEM-H11841



直喷中冷器出气管到中冷箱
E320C(中冷) 210-8011

YEM-H11842



中冷器出气软管
E320D电喷/323D 265-3599

YEM-H11843



E320C(中冷)/320D
直喷 204-0947

YEM-H11844



搭桥管
E330D/336D/E329D 230-2866

YEM-H11845



增压器进气管
E330/330B 4N9216

YEM-H11846



进气管 E312C

YEM-H11847



涡轮增压进气管
E330C 193-2781

YEM-H11848



进气管
E345D 233-1262

YEM-H11849



中冷软管 PC220-7 PC270-7
PC200-7/210-7 6738-11-4840

YEM-H11850



中冷管
PC200-8MO 20Y-03-46310

YEM-H11851



增压器进气管
PC300-5/6 210-01-5222

YEM-H11852



中冷软管 PC220-7/270-7
PC200-7/210-7 6738-11-4870

YEM-H11853



中冷软管 6738-11-4810
PC220-7/270-7/200-7/210-7

YEM-H11854



进气管软管
PC60-5/6 201-01-6441

YEM-H11855



中冷器软管
PC300-6 6223-13-4730/4630

YEM-H11856



中冷器进气管软管
PC300-7/360-7
6743-11-4940/4941

YEM-H11857



中冷器软管
PC300-8 207-01-75270

YEM-H11858



中冷器软管
PC300-8 207-03-75250

YEM-H11859



中冷器软管
PC300-8 6152-12-4420

YEM-H11860



中冷管出气管
PC300-8 207-03-76430

YEM-H11861



中冷器出气管
PC400-7/450-7
6156-11-4470

YEM-H11862



























PC300-7/360-7
6743-11-4930/4931

YEM-H11863

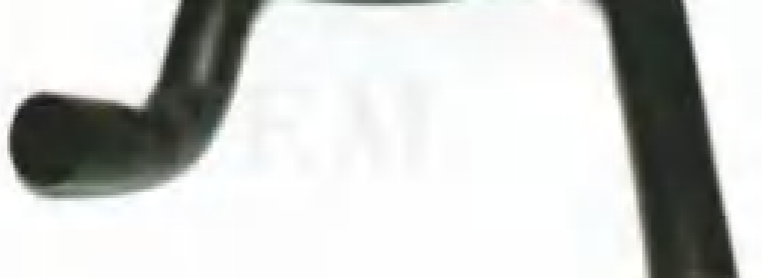

























增压器进气管
PC350-7 207-01-72160

























进气管 AIRDUST HOSE

<p>YEM-H11864</p>  <p>中冷器进气软管 PC300-7/360-7 6743-11-4960/4961</p>	<p>YEM-H11865</p>  <p>PC300-8MO 207-01-72391</p>	<p>YEM-H11866</p>  <p>PC128UU</p>	<p>YEM-H11867</p>  <p>PC400-7/450-7 208-01-72161</p>
<p>YEM-H11868</p>  <p>中冷进气管 PC400-7 6156-11-4460</p>	<p>YEM-H11869</p>  <p>中冷器软管 PC400-7 6156-11-4480</p>	<p>YEM-H11870</p>  <p>空滤进气管 PC400-7</p>	<p>YEM-H11871</p>  <p>PC400-7/450-7 208-01-72161</p>
<p>YEM-H11872</p>  <p>中冷器进气软管 PC400-8 208-03-76650</p>	<p>YEM-H11873</p>  <p>中冷器软管 PC400-8 208-03-75491</p>	<p>YEM-H11874</p>  <p>中冷器进气软管 PC400-8 208-03-76660</p>	<p>YEM-H11875</p>  <p>进气管 PC120-6(4D1012) 203-01-61232</p>
<p>YEM-H11876</p>  <p>进气管 黑色 PC120-6(4D95) 203-01-67520</p>	<p>YEM-H11877</p>  <p>进气管 黑色 PC120-5203-01-51221</p>	<p>YEM-H11878</p>  <p>进气管 黑色 PC60-6</p>	<p>YEM-H11879</p>  <p>进气管 PC60-7(4D95)</p>
<p>YEM-H11880</p>  <p>进气管PC60-7(4D102) 201-01-6441</p>	<p>YEM-H11881</p>  <p>空气管长 PC300-7207-01-72110</p>	<p>YEM-H11882</p>  <p>PC75 进气管121W-01-21330</p>	<p>YEM-H11883</p>  <p>塑料 PC200-8 MO</p>
<p>YEM-H11884</p>  <p>塑料 PC200-8 EO</p>	<p>YEM-H11885</p>  <p>塑料 PC240-8 MO</p>	<p>YEM-H11886</p>  <p>吹梳头 PC300-5/6 207-01-62110</p>	<p>YEM-H11887</p>  <p>空气管 ZAX60 3109825H</p>

进气管 AIRDUST HOSE

<p>YEM-H11888</p>  <p>中冷管 ZAX200-5G 4725703</p>	<p>YEM-H11889</p>  <p>中冷管 ZAX470 4644282H</p>	<p>YEM-H11890</p>  <p>中冷管 ZAX470 4644284H</p>	<p>YEM-H11891</p>  <p>中冷管 ZAX470-3 4644285H</p>
<p>YEM-H11892</p>  <p>空气软管 ZAX70 3091185H/3091195H</p>	<p>YEM-H11893</p>  <p>中冷器软管 ZAX120/130 4411937H</p>	<p>YEM-H11894</p>  <p>6HK1 直喷长</p>	<p>YEM-H11895</p>  <p>6HK1 电喷长</p>
<p>YEM-H11896</p>  <p>塑料进气管 ZAX120</p>	<p>YEM-H11897</p>  <p>塑料进气管 ZAX450/470</p>	<p>YEM-H11898</p>  <p>EX200 4205597</p>	<p>YEM-H11899</p>  <p>ZAX130-1 3086845</p>
<p>YEM-H11900</p>  <p>EX300-2/3 2031765</p>	<p>YEM-H11901</p>  <p>连接管 YN11P01118P1 SK200-8/210-8/250-8</p>	<p>YEM-H11902</p>  <p>中冷器软管 SK330-8/350-8 LC05P01355P1</p>	<p>YEM-H11903</p>  <p>中冷管 SK330-6/E LC05P01088P2</p>
<p>YEM-H11904</p>  <p>增压器进气管 SK200-8 YN05P01439P1</p>	<p>YEM-H11905</p>  <p>气管 SK330-8/350-8 LQ05P01526P1</p>	<p>YEM-H11906</p>  <p>增压器接管 SK330-8</p>	<p>YEM-H11907</p>  <p>中冷管 SK330-8/350-8 LC05P01424P1</p>
<p>YEM-H11908</p>  <p>增压器接管 SK350-8 VHSZ92033895</p>	<p>YEM-H11909</p>  <p>中冷管 SK330-6/E LC05P01089P2</p>	<p>YEM-H11910</p>  <p>4BD1/4BG1 SK100-2/5/6 2444Z2700</p>	<p>YEM-H11911</p>  <p>增压器进气管 SK320-6(L漏斗形) ME078462</p>

























进气管 AIRDUST HOSE

<p>YEM-H11912</p>  <p>中冷器软管 SK200-8/250-8 YN05P01236P2</p>	<p>YEM-H11913</p>  <p>中冷管直 SK460-8 LS05P0147P1</p>	<p>YEM-H11914</p>  <p>液压油管 SK460-8 LS30H0119P1</p>	<p>YEM-H11915</p>  <p>中冷管 SK460-8 LS05P01360P1</p>
<p>YEM-H11916</p>  <p>SK75-8 中冷管</p>	<p>YEM-H11917</p>  <p>中冷进气管 SK75-8 YT05P01181P1</p>	<p>YEM-H11918</p>  <p>中冷管 SK130-8 LPO5P01007P1</p>	<p>YEM-H11919</p>  <p>吹梳头 SK200 2444Z2309</p>
<p>YEM-H11920</p>  <p>中冷进气管 SK460-8 LS05P01394P1</p>	<p>YEM-H11921</p>  <p>中冷器软管 SK230-6E LQ05P01092P2</p>	<p>YEM-H11922</p>  <p>中冷器软管 SK230-6E LQ05P01034P2</p>	<p>YEM-H11923</p>  <p>空滤进气管 SK250-6E YN11P01040P1</p>
<p>YEM-H11924</p>  <p>空气连接管 SK120-5 2444Z2411</p>	<p>YEM-H11925</p>  <p>增压器接管 SK330-6</p>	<p>YEM-H11926</p>  <p>进气管 塑料 SK200-6</p>	<p>YEM-H11927</p>  <p>中冷管 VOLV0210 VOE11110498</p>
<p>YEM-H11928</p>  <p>中冷进气管 VOLVO300D</p>	<p>YEM-H11929</p>  <p>中冷进气管 EC240 VOE15084140NOE11110495</p>	<p>YEM-H11930</p>  <p>EC240BLG/290BLG VOE20450714</p>	<p>YEM-H11931</p>  <p>EC210BLC VOE20459250</p>
<p>YEM-H11932</p>  <p>进气管 EC460 14609400</p>	<p>YEM-H11933</p>  <p>增压器进气管 EC460 14527364</p>	<p>YEM-H11934</p>  <p>中冷管 EC240/290 3183620</p>	<p>YEM-H11935</p>  <p>进气管 EC240 14520267</p>

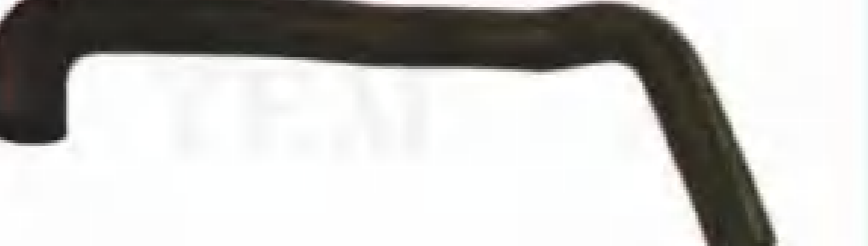























进气管 AIRDUST HOSE

<p>YEM-H11936</p>  <p>中冷管 EC240/290 14506558</p>	<p>YEM-H11937</p>  <p>进气管 EC240 14532126</p>	<p>YEM-H11938</p>  <p>进气管 EC240/290 14509443</p>	<p>YEM-H11939</p>  <p>进气管 EC360 14530222</p>
<p>YEM-H11940</p>  <p>进气管 EC460 14506526</p>	<p>YEM-H11941</p>  <p>进气管 EC480D 14578951</p>	<p>YEM-H11942</p>  <p>进气管 C360 14509316</p>	<p>YEM-H11943</p>  <p>空气进气管 EC240 14572802</p>
<p>YEM-H11944</p>  <p>VOLVO210 D6D 14518258</p>	<p>YEM-H11945</p>  <p>VOLVO210 14585891</p>	<p>YEM-H11946</p>  <p>中冷管 EC210 14618181</p>	<p>YEM-H11947</p>  <p>中冷管 EC360/460 11110495</p>
<p>YEM-H11948</p>  <p>中冷管 EC210 11110498</p>	<p>YEM-H11949</p>  <p>中冷管 EC240/290 14513279</p>	<p>YEM-H11950</p>  <p>冷却水管 EC360/460 14636066</p>	<p>YEM-H11951</p>  <p>呼吸器排气管 EC240 20405629</p>
<p>YEM-H11952</p>  <p>进气管 EC210 14586973</p>	<p>YEM-H11953</p>  <p>增压器空滤管 塑料 EC210</p>	<p>YEM-H11954</p>  <p>增压器空滤管 塑料 EC210D</p>	<p>YEM-H11955</p>  <p>VOLVO 14636663</p>
<p>YEM-H11956</p>  <p>VOLVO 14636664</p>	<p>YEM-H11957</p>  <p>VOLVO 14636636</p>	<p>YEM-H11958</p>  <p>VOLVO 14636637</p>	<p>YEM-H11959</p>  <p>VOLVO 14636662</p>

























进气管 AIRDUST HOSE

<p>YEM-H11960</p>  <p>VOLVO 14529843</p>	<p>YEM-H11961</p>  <p>VOLVO 14636984</p>	<p>YEM-H11962</p>  <p>VOLVO 14607314</p>	<p>YEM-H11963</p>  <p>空气管(长) DH220-5</p>
<p>YEM-H11964</p>  <p>空气管(短) DH220-5</p>	<p>YEM-H11965</p>  <p>空气管 DX60 K1027497A</p>	<p>YEM-H11966</p>  <p>空气管 DX150 420101-00386A</p>	<p>YEM-H11967</p>  <p>空气管 DX150 420101-00387A</p>
<p>YEM-H11968</p>  <p>空气管 DX225 K1000562</p>	<p>YEM-H11969</p>  <p>空气管 DX260 2185-1658</p>	<p>YEM-H11970</p>  <p>空气管 DX300 185-00383</p>	<p>YEM-H11971</p>  <p>空气管 DX300 K1029045</p>
<p>YEM-H11972</p>  <p>空气管 185-00249 DX345/DX380/DH370-7</p>	<p>YEM-H11973</p>  <p>空气管 DX345 K1005119</p>	<p>YEM-H11974</p>  <p>空气管 DX345 420101-00343</p>	<p>YEM-H11975</p>  <p>空气管 DX380 420101-00364</p>
<p>YEM-H11976</p>  <p>空气管 DX380 420101-00363</p>	<p>YEM-H11977</p>  <p>空气管 DX420 420101-00715</p>	<p>YEM-H11978</p>  <p>空气过滤器软管 DH55 2184-1273B</p>	<p>YEM-H11979</p>  <p>软管 DH55 2184-1286</p>
<p>YEM-H11980</p>  <p>SH200A5 增压器中冷管</p>	<p>YEM-H11981</p>  <p>SH200A5 45度</p>	<p>YEM-H11982</p>  <p>SH200A5</p>	<p>YEM-H11983</p>  <p>SH120 进气管</p>























进气管 AIRDUST HOSE

<p>YEM-H11984</p>  <p>SH265 进气管</p>	<p>YEM-H11985</p>  <p>SH200 长</p>	<p>YEM-H11986</p>  <p>SH200 短</p>	<p>YEM-H11987</p>  <p>SH350-5 一头90-一头100 空气管</p>
<p>YEM-H11988</p>  <p>R225-7 空滤管 七字形 两头100</p>	<p>YEM-H11989</p>  <p>R225-7/305-7/320-7 中冷管 两头90</p>	<p>YEM-H11990</p>  <p>R220-5 空滤管 100*100*600</p>	<p>YEM-H11991</p>  <p>R215-9 1BQ6-26030-DH</p>
<p>YEM-H11992</p>  <p>进气管 R150-9</p>	<p>YEM-H11993</p>  <p>R215-9</p>	<p>YEM-H11994</p>  <p>R215-9 11Q6-26020</p>	<p>YEM-H11995</p>  <p>R215-9 11Q6-26010</p>
<p>YEM-H11996</p>  <p>R215-9 1BQ6-26030-DH</p>	<p>YEM-H11997</p>  <p>增压器进气管 R225VS 11N6-23310</p>	<p>YEM-H11998</p>  <p>空滤进气管 R225VS 11Q6-20070</p>	<p>YEM-H11999</p>  <p>增压器进气管 R265-9 11Q7-20080</p>
<p>YEM-H12000</p>  <p>空滤进气管 R265-9</p>	<p>YEM-H12001</p>  <p>进气管 R375-7</p>	<p>YEM-H12002</p>  <p>增压进气管 R335-7 11NA-20010</p>	<p>YEM-H12003</p>  <p>空滤进气管 R455 20012</p>
<p>YEM-H12004</p>  <p>增压器进气管 R455</p>	<p>YEM-H12005</p>  <p>三-215 A82060601111922569</p>	<p>YEM-H12006</p>  <p>三-335</p>	<p>YEM-H12007</p>  <p>三-75C</p>

进气管 AIRDUST HOSE

<p>YEM-H12008</p>  <p>三一75C 12980733</p>	<p>YEM-H12009</p>  <p>三一75C 12980752</p>	<p>YEM-H12010</p>  <p>中冷管 三一425 SO16F11989854</p>	<p>YEM-H12011</p>  <p>三一425 SO18F 12225566</p>
<p>YEM-H12012</p>  <p>进气管 三一135 S008F10072577</p>	<p>YEM-H12013</p>  <p>三一335 A820606030824</p>	<p>YEM-H12014</p>  <p>进气管 三一55 11144768</p>	<p>YEM-H12015</p>  <p>三一65 10053484</p>
<p>YEM-H12016</p>  <p>三一65 10053480</p>	<p>YEM-H12017</p>  <p>三一65 10237835</p>	<p>YEM-H12018</p>  <p>三一135 10072576 增压进气管</p>	<p>YEM-H12019</p>  <p>三一215 A82060601111922569</p>
<p>YEM-H12020</p>  <p>三一235-8 增压进气管</p>	<p>YEM-H12021</p>  <p>三一245 中冷管</p>	<p>YEM-H12022</p>  <p>空滤进气管 三一335 SY001F SY12685078</p>	<p>YEM-H12023</p>  <p>三一335 12119616-1</p>
<p>YEM-H12024</p>  <p>三一335 A820606030825</p>	<p>YEM-H12025</p>  <p>进气管 柳工920D/922 30A0753</p>	<p>YEM-H12026</p>  <p>进气管 柳工923/927D 32A0652</p>	<p>YEM-H12027</p>  <p>进气管 徐工150</p>
<p>YEM-H12028</p>  <p>进气管 徐工210</p>	<p>YEM-H12029</p>  <p>进气管 徐工370 AH063002</p>	<p>YEM-H12030</p>  <p>中冷管 徐工470</p>	<p>YEM-H12031</p>  <p>进气管徐工470 CC-028</p>

进气管 AIRDUST HOSE

<p>YEM-H12032</p>  <p>进气管 徐工700</p>	<p>YEM-H12033</p>  <p>进气管 柳工205/225C 32A0286</p>	<p>YEM-H12034</p>  <p>进气管 柳工915D 32A0826</p>	<p>YEM-H12035</p>  <p>进气管 柳工915D</p>
<p>YEM-H12036</p>  <p>进气管 柳工920D/922 30A0752</p>	<p>YEM-H12037</p>  <p>进气管中联360</p>	<p>YEM-H12038</p>  <p>临工210(短)</p>	<p>YEM-H12039</p>  <p>临工210 长</p>
<p>YEM-H12040</p>  <p>JCB220</p>	<p>YEM-H12041</p>  <p>JCM906 Y160-07A-000040</p>	<p>YEM-H12042</p>  <p>JCM906 Y160-07A-000050</p>	<p>YEM-H12043</p>  <p>JCM907 07Y-07A-00001</p>
<p>YEM-H12044</p>  <p>JCM907 07Y-07B-00002</p>	<p>YEM-H12045</p>  <p>JCM907 07Y-07B-00004</p>	<p>YEM-H12046</p>  <p>JCM908 08L-07-00004</p>	<p>YEM-H12047</p>  <p>JCM908 08L-07-00002</p>
<p>YEM-H12048</p>  <p>JCM913 13Y-07A-00001</p>	<p>YEM-H12049</p>  <p>CM913 13Y-07E-00001</p>	<p>YEM-H12050</p>  <p>JCM923 23Y-07-00002</p>	<p>YEM-H12051</p>  <p>JCM933 Y233-07A-000010</p>
<p>YEM-H12052</p>  <p>JCM933 33Y-04-00006</p>	<p>YEM-H12053</p>  <p>JCM933 33YY-07-00002</p>	<p>YEM-H12054</p>  <p>进气管 约翰迪尔</p>	

排气管 EXHAUST PIPE

YEM-H12055



小松12V140E-3 中节 6215-11-5172

YEM-H12056



小松12V140E-3 中节 6215-11-5182

YEM-H12057



小松WA380-6.6754-11-5120

YEM-H12058

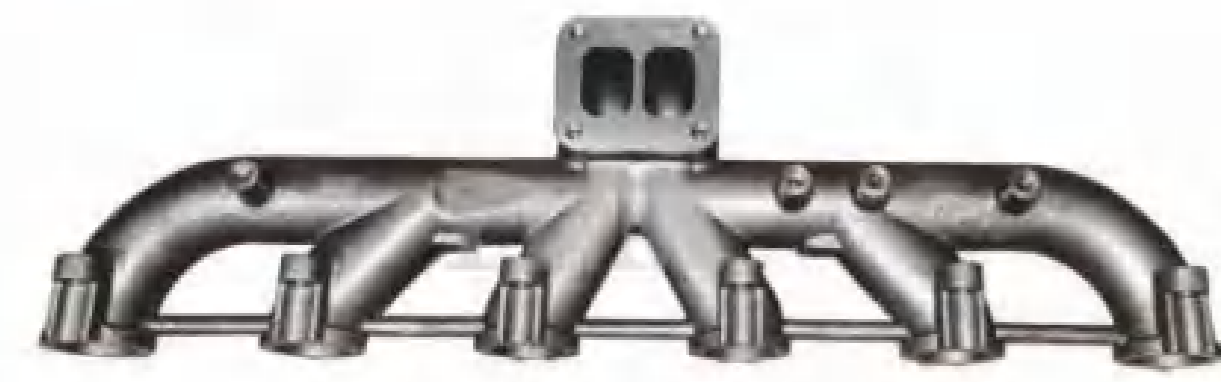

小松6D114 PC360-7 3929778

YEM-H12059



小松12V140-1中节6215-11-5140

YEM-H12060



小松12V140-1中节6215-11-5150

YEM-H12061



小松4D107 6751-11-5111

YEM-H12062



6D125中间节
6150-11-5140 6150-11-5120

YEM-H12063



6D125中间节
6151-11-5140 6151-11-5150

YEM-H12064



6D125中间节 6151-12-5120

YEM-H12065



PC200-8MO

YEM-H12066

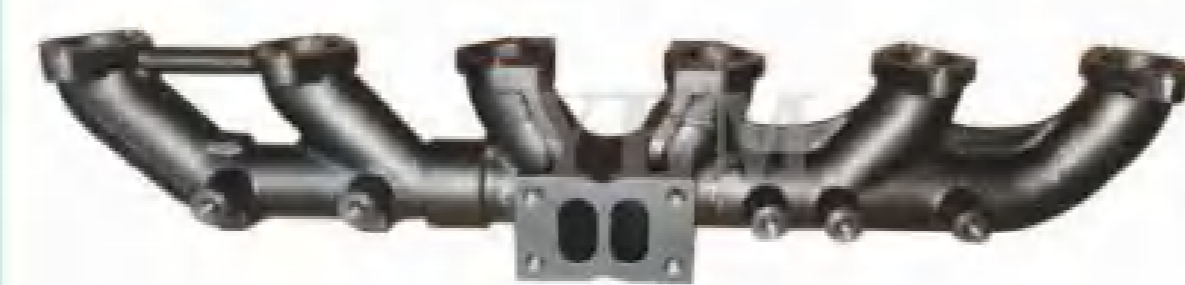

PC350-8两段式

YEM-H12067



PC400-6中间节 6151-11-5160

YEM-H12068



PC400-7后 6151-11-5130

YEM-H12069



PC400-7中间节 6151-11-5120

YEM-H12070

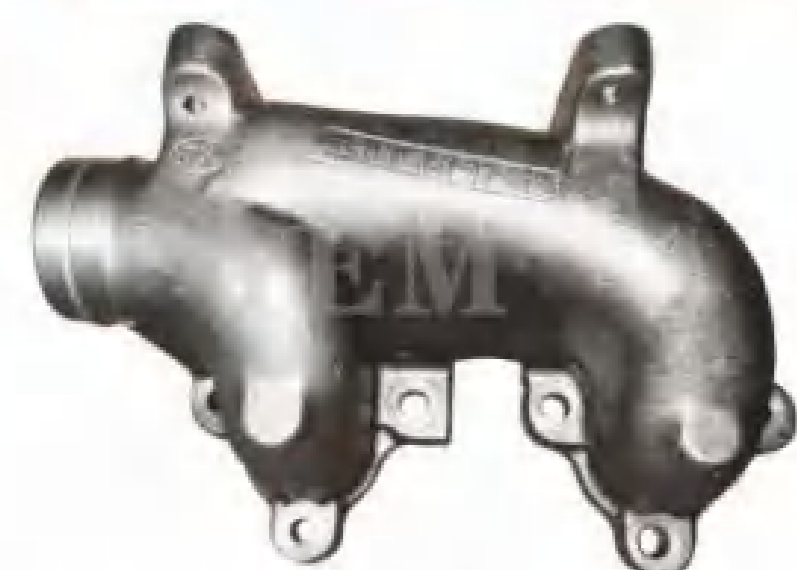

PC450-7前6151-11-5110

YEM-H12071



PC450-8后节6251-11-5130

YEM-H12072

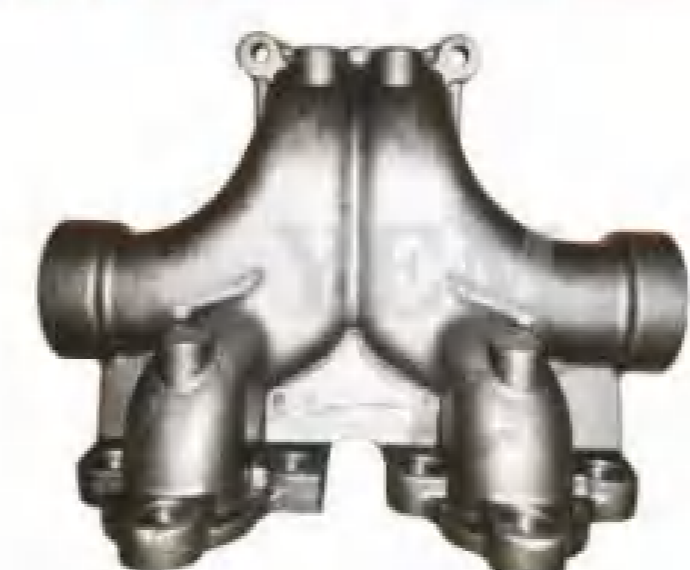

PC450-8中间节6251-11-5120

排气管 EXHAUST PIPE

YEM-H12073



卡特C2.6

YEM-H12074



卡特C6.6

YEM-H12075



卡特C7,E325,E329

YEM-H12076



6732-11-5221

YEM-H12077



沃尔沃EC210 D6E

YEM-H12078



沃尔沃EC250 D7E

YEM-H12079



沃尔沃D7D

YEM-H12080



VOLVO140

YEM-H12081



大宇300-7, 大宇225-9

YEM-H12082



大宇DX380

YEM-H12083



DH370/420/500

YEM-H12084

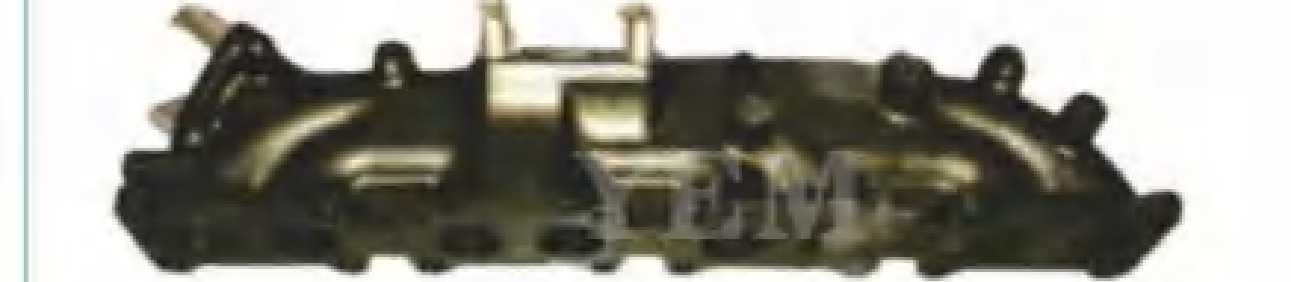

4M50 HD820R

YEM-H12085

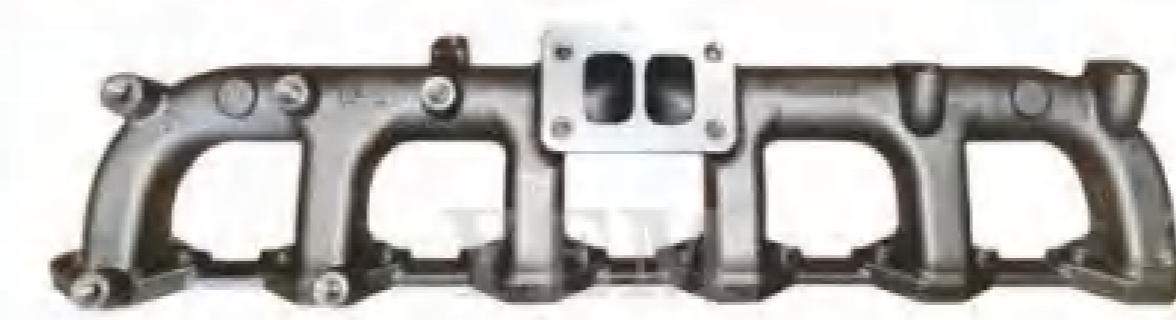

6D34 HD820-3 新款

YEM-H12086



五十铃 4JG1 DH55 ZAX70

YEM-H12087



五十铃(ISUZU)6BB1 914140-630

YEM-H12088



洋马4TNV84

YEM-H12089



洋马4TNV88

YEM-H12090



洋马4TNV94

YEM-H12091



6D16R专用, R215-7

YEM-H12092

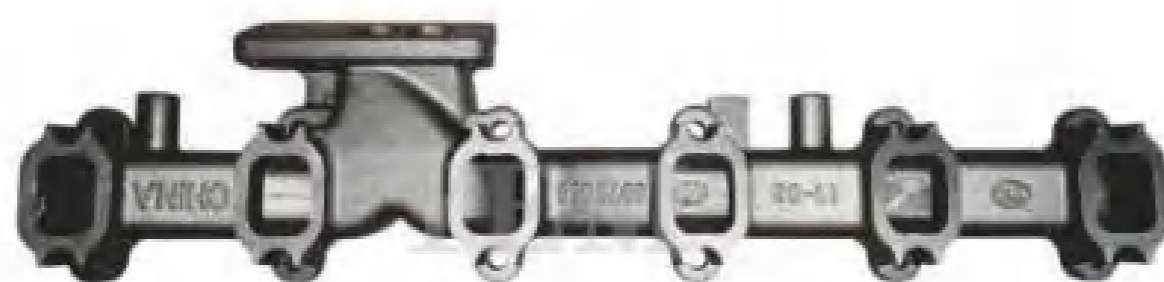

WA320-5 6735-11-5220

YEM-H12093



凯斯80

YEM-H12094



日野J08E
SK350-8 SK360-8 SK330-8 SK380D

YEM-H12095



约翰迪尔S660

YEM-H12096



4BG1 进气铝管

YEM-H12097



6BG1 进气铝管

YEM-H12098



4D95 进气铝管

YEM-H12099



4TNV94 进气铝管

YEM-H12100



4M40

YEM-H12101



美国装载机

YEM-H12102



WA320-5

YEM-H12103



WA420-3

YEM-H12104



6HK1 电喷 进气铝管

YEM-H12105



6HK1 直喷 进气铝管

YEM-H12106



E320C 进气支管 带中冷

YEM-H12107



凯斯210

YEM-H12108



J05E进气铝管

YEM-H12109



优质 DH55

YEM-H12110



优质 SY75

YEM-H12111



优质 SK200-5

YEM-H12112



优质 R60-7

YEM-H12113



HD820R

YEM-H12114



三一-215-9

YEM-H12115



三一-215/235-8

YEM-H12116



YC85-6/7/8

YEM-H12117



DX60 黑

YEM-H12118



DX260/300

YEM-H12119



厦工815/822/825/836

YEM-H12120



脚踏板胶 HD820R 短

YEM-H12121



脚踏板胶 HD820R长

YEM-H12122



脚踏板胶 SH200-A5

YEM-H12123



脚踏板胶 E307/200B

YEM-H12124



山河智能

YEM-H12125



山河智能

YEM-H12126



山河智能100以上机

YEM-H12139



卡特307.5

YEM-H12140



卡特200B

YEM-H12141



卡特307/308C

YEM-H12127



龙工60/65/75/85

YEM-H12128



龙工225

YEM-H12129



龙工60/65/75/85

YEM-H12142



卡特320C

YEM-H12143



卡特GC/新款

YEM-H12144



卡特320B

YEM-H12130



临工200以下机

YEM-H12131



临工200以上

YEM-H12132



临工200以上

YEM-H12145



卡特305/307

YEM-H12146



卡特307.5

YEM-H12147



卡特V1V2

YEM-H12133



玉柴85

YEM-H12134



优质 R215-7

YEM-H12135



优质 DH60-7

YEM-H12148



卡特GC/新款

YEM-H12149



卡特307/308C

YEM-H12150



卡特320D

YEM-H12136



优质 VOLV0210

YEM-H12137



优质 SH210-5

YEM-H12138



优质 PC60-7

YEM-H12151



卡特200B

YEM-H12152



卡特307/308C

YEM-H12153



卡特305/307

YEM-H12154



小松老款

YEM-H12155



小松56-7

YEM-H12156



小松60-7/120-6E

YEM-H12169



日立直喷

YEM-H12170



日立200-5

YEM-H12171



日立电喷

YEM-H12157



小松60/70-8

YEM-H12158



小松200-6

YEM-H12159



小松78U/128U

YEM-H12172



日立60/70

YEM-H12173



日立200-5

YEM-H12174



日立-5A/5G

YEM-H12160



小松78U/128U

YEM-H12161



小松60-8

YEM-H12162



小松老款

YEM-H12175



神钢-10

YEM-H12176



神钢-3/5

YEM-H12177



神钢-6

YEM-H12163



小松215-10

YEM-H12164



小松-7

YEM-H12165



小松215-10

YEM-H12178



神钢60/70/135SR

YEM-H12179



神钢-8/超8

YEM-H12180



60/70/135SR

YEM-H12166



小松200-6

YEM-H12167



小松60-7/120-6E

YEM-H12168



日立-5G/5A

YEM-H12181



神钢-3/5

YEM-H12182



神钢-10

YEM-H12183



神钢-8/超8

地板胶 CAB RUBBER CARPET

地板胶 CAB RUBBER CARPET



YEM-H12214



三一-200/205/215-8/9/10

YEM-H12215



75C/75-8/9/10

YEM-H12216



三一-55/60

YEM-H12229



三一-75新款一键启动

YEM-H12230



徐工75新款

YEM-H12231



徐工80

YEM-H12217



一键启动 三一-205/215CDPC

YEM-H12218



三一-75新款一键启动

YEM-H12219



三一-135-8/9/10

YEM-H12232



徐工60

YEM-H12233



徐工200以上机

YEM-H12234



徐工200以上机

YEM-H12220



三一-55/60新款一键启动

YEM-H12221



三一-200PULS新款全包围

YEM-H12222



三一-205/215ACE 保时捷款全包围

YEM-H12235



徐工130/135D

YEM-H12236



柳工

YEM-H12237



柳工E型

YEM-H12223



三一-26U

YEM-H12224



三一-200/205/215-8/9/10

YEM-H12225



三一-135-8/9/10

YEM-H12238



柳工906/908D

YEM-H12239



柳工906/908D

YEM-H12240



柳工906D

YEM-H12226



三一-26U

YEM-H12227



三一-200PULS新款

YEM-H12228



三一-55/60新款一键启动

YEM-H12241



柳工E型

YEM-H12242



久保田161-3

YEM-H12243



久保田161-3

引导轮前叉 THE FRONT FORK -ILDER
车架总成 DERSRANE ASSY

快换接头 抓木器 振动夯
QUICK CONVERSION JOINT/LOG GRAPPLE/
VIBRATING COMPACTOR



车架总成

